

# MiVoice Office 250

5360 IP PHONE USER GUIDE

RELEASE 6.2



## **NOTICE**

The information contained in this document is believed to be accurate in all respects but is not warranted by Mitel Networks™ Corporation (MITEL®). The information is subject to change without notice and should not be construed in any way as a commitment by Mitel or any of its affiliates or subsidiaries. Mitel and its affiliates and subsidiaries assume no responsibility for any errors or omissions in this document. Revisions of this document or new editions of it may be issued to incorporate such changes.

No part of this document can be reproduced or transmitted in any form or by any means - electronic or mechanical - for any purpose without written permission from Mitel Networks Corporation.

For additional information and/or technical assistance in North America, certified technicians may contact:

Mitel Networks Corporation  
Technical Support Department (USA)  
1146 North Alma School Road  
Mesa, AZ 85201  
1-888-777-EASY (3279)

### **Trademarks**

The trademarks, service marks, logos and graphics (collectively "Trademarks") appearing on Mitel's Internet sites or in its publications are registered and unregistered trademarks of Mitel Networks Corporation (MNC) or its subsidiaries (collectively "Mitel") or others. Use of the Trademarks is prohibited without the express consent from Mitel. Please contact our legal department at [legal@mitel.com](mailto:legal@mitel.com) for additional information. For a list of the worldwide Mitel Networks Corporation registered trademarks, please refer to the website: <http://www.mitel.com/trademarks>.

### **5360 IP Phone User guide**

Release 6.2

June 2016

®,™ Trademark of Mitel Networks Corporation  
© Copyright 2016, Mitel Networks Corporation  
All rights reserved

---

## Notice

This guide is released by Mitel Networks Corporation and provides information necessary to use the 5360 IP Phone. The guide contents, which reflect current Mitel standards, are subject to revision or change without notice.

Some features or applications mentioned may require a future release and are not available in the initial release. Future product features and applications are subject to availability and cost. Some features or applications may require additional hardware, software, or system administrator assistance.

**For sales, service, or technical support, contact your local authorized provider:**

---

Enter provider information above.

If you do not know the contact information for your local provider, use the "Partners" link at the top of the [Mitel home page](http://www.mitel.com) (www.mitel.com) to find a location near you.

If you have any questions or comments regarding this user guide or other technical documentation, contact the Technical Publications Department (USA) at:

[tech\\_pubs@mitel.com](mailto:tech_pubs@mitel.com)

The trademarks, service marks, logos and graphics (collectively "Trademarks") appearing on Mitel's Internet sites or in its publications are registered and unregistered trademarks of Mitel Networks Corporation (MNC) or its subsidiaries (collectively "Mitel") or others. Use of the Trademarks is prohibited without the express consent from Mitel. Please contact our legal department at [legal@mitel.com](mailto:legal@mitel.com) for additional information. For a list of the worldwide Mitel Networks Corporation registered trademarks, please refer to the website: <http://www.mitel.com/trademarks>.

© 2010-2015 Mitel Networks Corporation

Personal use of this material is permitted. However, permission to reprint/republish this material for advertising or promotional purposes or for creating new collective works for resale or redistribution to servers or lists, or to reuse any copyrighted component of this work in other works must be obtained from Mitel.

---

## Important Safety Instructions and Precautions

Remember the following safety guidelines when using the IP phone.





### Programming Emergency Numbers

Make sure to do the following when programming emergency numbers and/or making test calls to emergency numbers:

- Remain on the line and briefly explain to the dispatcher the reason for the call.
- Perform tests during off-peak hours such as early morning or late evenings.

### Safety Notices

The following notices may appear on the product or in the technical documentation.

Notice	Description
 <b>CAUTION</b>	Caution indicates a potentially hazardous situation which, if not avoided, may result in minor or moderate injury and/or damage to the equipment or property.
 <b>WARNING</b>	Warning indicates a potentially hazardous situation which, if not avoided, could result in death or serious injury.
 <b>DANGER</b>	Danger indicates an imminently hazardous situation which, if not avoided, will result in death or serious injury.
	The exclamation point within an equilateral triangle indicates that important operating and maintenance (servicing) instructions are included in the literature accompanying the product.

### Maintenance and Repair

There are no user serviceable parts inside the IP phone. For repairs, return the IP phone to an authorized Mitel provider.

---

**NOTE**

Changes or modifications not expressly approved by Mitel may void the user's right to operate the equipment.

---

## Power Requirements

### CAUTION

**Phone Damage Hazard.** To avoid damaging the IP phone, make sure the IP phone is connected to the proper power supply before powering on. Contact your system administrator for more information.

The IP phone requires *any* one of the following power supplies:

- Mitel 48-volt DC Ethernet power adaptor 100-240 volt AC 50-60Hz (ES), part number 50005301
- An industry-standard IEEE 802.3af Power over Ethernet (PoE) power supply unit
- IEEE 802.3af compliant Gigabit power supply, part number 51015131

If your IP phone uses a centralized PoE power supply unit, do **not** use the 48-volt DC Ethernet power adaptor. If necessary, contact your system administrator for assistance before connecting your IP phone to the centralized power source.

Make sure the IP phone is plugged into an uninterruptible power supply (UPS). If your IP phone is plugged into the UPS and the power fails, it should remain powered on for about 10 minutes. If the IP phone is not plugged into a UPS and the power fails, the current call is dropped and you will not be able to use the IP phone until the power is restored.

## Software Updates

### CAUTION

**Phone Damage Hazard.** Do not use your IP phone or disconnect it from the power supply while it is updating software.

The IP phone may require occasional software updates when new versions are available. The IP phone is configured to download the updates automatically. Contact your system administrator for more information.

## Product Disposal Instructions



This symbol indicates that the product is classified as electrical or electronic equipment and should not be disposed of with other commercial or household waste at the end of its working life. For appropriate disposal and recycling instructions, contact your local Mitel provider.

*The Waste of Electrical and Electronic Equipment (WEEE) Directive (2002/96/EC) was established by the European Union to minimize negative impact on the environment, control hazardous substances, and curtail landfill expansion by using the best available recovery and recycling techniques.*

---

## Phone Usage

This equipment is not for connection to the telephone network or public coin phone service. It is only for use when connected to Mitel systems.

### **WARNING**

When using your IP phone equipment, basic safety precautions should always be followed to reduce the risk of fire, electric shock and injury to persons, including the following:

- Do not use this product near water, for example, near a bath tub, wash bowl, kitchen sink or laundry tub, in a wet basement, or near a swimming pool.
- Avoid using a phone (other than a cordless type) during an electrical storm. There may be a remote risk of electric shock from lightning.
- Do not use the IP phone to report a gas leak in the vicinity of a leak.
- Do not connect directly to the Public Switched Telephone Network (PSTN). Any connection of this phone to an off premise application, an out of plant application, any other exposed plant application, or to any equipment other than the intended application may result in a safety hazard, and/or defective operation, and/or equipment damage. "Exposed plant" means where any portion of the circuit is subject to accidental contact with electric lighting or power conductors operating at a voltage exceeding 300 volts between conductors or is subject to lightning strikes.
- The socket outlet, if used, shall be located near the equipment and shall be easily located by the user.
- Use only Mitel approved power adaptors. See "Power Requirements" on [page v](#).
- The handset supplied with the IP phone is not certified for use with any other phone. Use of the handset with any other phone may have the potential to cause hearing loss in the event of a lightning strike on the outside plant wiring.

---

## Notice to Canadian Customers

The Class B digital apparatus complies with Canadian ICES-003.

## Notice to U.S. Customers

This equipment has been tested and found to comply with the limits for a Class B digital device, pursuant to Part 15 of the FCC Rules. These limits are designed to provide reasonable protection against harmful interference in a residential installation. This equipment generates, uses, and can radiate radio frequency energy and, if not installed and used in accordance with the instructions, may cause harmful interference to radio communications. However, there is no guarantee that interference will not occur in a particular installation. If this equipment does cause harmful interference to radio or television reception, which can be determined by turning the equipment off and on, the user is encouraged to try to correct the interference by one or more of the following measures:

- Reorient or relocate the receiving antenna.
- Increase the separation between the equipment and receiver.
- Connect the equipment into an outlet on a circuit different from that to which the receiver is connected.
- Consult the dealer or an experienced radio/TV technician for help.

## Notice to European Customers



We, Mitel Networks LTD.  
Of, Mitel Castlegate Business Park  
Portskewett  
Caldicot  
NP26 5YR  
UK

Declare that for the hereinafter mentioned product the presumption of conformity with the applicable essential requirements of DIRECTIVE 1999/5/EC OF THE EUROPEAN PARLIAMENT (RTTE DIRECTIVE) AND OF THE COUNCIL is given.

Mitel IP Phone: 5360

Any unauthorized modification of the product voids this Declaration.

For a copy of the original signed Declaration of Conformity (in full conformance with EN45014), please contact the Regulatory Approvals Manager at the above address.





---

# Contents

## Getting Started 1

---

<b>Welcome</b> .....	<b>1</b>
<b>About Your IP Phone</b> .....	<b>1</b>
5360 IP Phone Features .....	2
Phone Feature Descriptions .....	3
Handset .....	3
Display and Softkeys .....	3
Status Bar .....	3
Gadget Sidebar .....	3
Ring/Message Indicator .....	3
Feature Buttons .....	5
Dialpad Buttons .....	5
Programmable Buttons .....	6
Navigation Page Buttons .....	6
External Speaker .....	6
<b>Phone Signals</b> .....	<b>7</b>
<b>Comfort and Safety Tips</b> .....	<b>7</b>
<b>Viewing the Phone Information</b> .....	<b>8</b>
<b>Cleaning Your IP Phone</b> .....	<b>8</b>
<b>Using a Headset</b> .....	<b>8</b>
<b>Using the 5310 IP Conference Unit</b> .....	<b>9</b>
Accessing/Exiting the Conference Controller Application .....	9
Turning the Conference Unit On and Off .....	9
Adjusting the Conference Unit Volume .....	9
Muting the Conference Unit .....	10
Placing the Conference Unit in Presentation Mode .....	10
<b>Using the Line Interface Module (LIM)</b> .....	<b>11</b>
Making and Answering Calls Using the Analog Button .....	12
Making and Answering Calls Using the Failover Mode .....	13

## Personalizing Your Phone 15

---

<b>Adjusting the Viewing Angle</b> .....	<b>15</b>
<b>Changing Volume Levels</b> .....	<b>16</b>
<b>Changing the Ring Tone</b> .....	<b>16</b>
<b>Adjusting the Display Brightness</b> .....	<b>16</b>
<b>Changing the Language</b> .....	<b>17</b>
<b>Changing the Text Size on the Display</b> .....	<b>18</b>

---

<b>Using the Screen Saver</b> .....	<b>19</b>
<b>Viewing Call History</b> .....	<b>20</b>
Viewing Call History .....	20
Deleting Call Records .....	21
Reviewing Call Record Icons .....	21
<b>Customizing Your Contact List</b> .....	<b>22</b>
Adding Names to Your Contact List .....	22
Editing Your Contact List .....	22
Dialing from Your Contact List .....	22
<b>Specifying Audio Feedback Options</b> .....	<b>23</b>
<b>Calibrating the Display</b> .....	<b>23</b>
<b>Using the Dialpad Buttons to Enter Characters</b> .....	<b>24</b>
<b>Using Programmable Buttons</b> .....	<b>26</b>
Default Access Codes .....	27
Outside Line Access Codes .....	27
Extension Numbers .....	27
Default Feature Codes .....	27
<b>Listening to Background Music</b> .....	<b>30</b>
<b>Viewing Button Assignments</b> .....	<b>30</b>
<b>Resetting Programmable Buttons</b> .....	<b>30</b>
<b>Resetting the IP Phone to the Default Settings</b> .....	<b>30</b>
<b>Switching Keymaps</b> .....	<b>31</b>
<b>Turning the Backlight on or off</b> .....	<b>31</b>
<b>Getting Help</b> .....	<b>31</b>
<b>Activating Door Relay</b> .....	<b>31</b>

## **Answering and Placing Calls** **33**

---

<b>Answering Calls</b> .....	<b>33</b>
Answering Waiting Calls .....	33
Using Automatic Call Access .....	33
Redirecting Calls .....	34
<b>Using Automatic Trunk Answer</b> .....	<b>34</b>
<b>Placing Calls</b> .....	<b>35</b>
Placing Emergency Calls .....	35
Placing Emergency Calls using the LIM Line .....	35
Placing Internal Calls .....	36
Requesting a Callback (Queuing the Phone) .....	36
Using Camp-on .....	36
Placing External Calls .....	37
Redialing a Number .....	37

<b>Using Speed Dial</b> .....	<b>38</b>
Using System Speed Dial .....	38
Using Station Speed Dial .....	38
Storing Station Speed-Dial Numbers .....	38
Dialing Station Speed-Dial Numbers .....	39
Deleting Station Speed-Dial Entries .....	39
Assigning Speed-Dial Numbers to Programmable Buttons .....	40
<b>Using the Directory</b> .....	<b>41</b>
<b>Using Account Codes</b> .....	<b>42</b>
<b>Call Features</b> .....	<b>43</b>
<b>Using Handsfree Mode</b> .....	<b>43</b>
<b>Using Ring Intercom Always</b> .....	<b>43</b>
<b>Using Mute</b> .....	<b>43</b>
<b>Placing Calls On Hold</b> .....	<b>44</b>
<b>Entering a Hookflash</b> .....	<b>44</b>
<b>Transferring Calls</b> .....	<b>45</b>
Transferring Calls to Other Extensions .....	45
Transferring Calls to External Numbers .....	45
Using Reverse Transfer .....	45
Parking a call and Picking up a Parked call .....	45
Using Group Call Pick-up .....	46
<b>Viewing Your System Information</b> .....	<b>47</b>
<b>Viewing Caller ID Information</b> .....	<b>47</b>
<b>Forwarding Calls</b> .....	<b>48</b>
Manual Call Forwarding .....	48
System Forwarding .....	48
<b>Using Dynamic Extension Express</b> .....	<b>49</b>
Using the Handoff - Push/Pull Feature .....	50
Receiving Message Waiting Indications .....	51
<b>Placing Ad Hoc Conference Calls</b> .....	<b>52</b>
Adding a Conference Party .....	52
Transferring a Conference .....	52
Dropping Out of a Conference .....	52
Ending a Conference and Placing all Parties on Hold .....	53
<b>Using Meet-Me Conferencing</b> .....	<b>54</b>
Conference Assistant .....	54
Access Codes .....	54
Setting Up a Meet-Me Conference .....	54
Joining a Meet-Me Conference .....	55

---

Dropping Out of a Meet-Me Conference .....	55
Putting a Meet-Me Conference on Hold.....	55
Transferring a Meet-Me Conference .....	55
<b>Using Record-A-Call .....</b>	<b>56</b>
<b>Using Group Listen .....</b>	<b>56</b>
<b>Using Call Logging .....</b>	<b>57</b>
<b>Using Secondary Extension Buttons.....</b>	<b>58</b>
<b>Using Hot Desking.....</b>	<b>59</b>
<b>Using the Configuration Assistant.....</b>	<b>60</b>
Changing Your Station Passcode .....	60
Accessing the Configuration Assistant.....	61
Changing the Dynamic Extension Express Settings .....	61
Changing the DND Settings.....	62
Changing the Manual Call Forwarding Settings.....	62
Managing Meet-Me Conferencing Access Codes .....	63
<b>Using E-Mail Synchronization .....</b>	<b>64</b>
<b>Using Remote Programming .....</b>	<b>64</b>
Changing the Dynamic Extension Express Settings .....	64
Changing the DND Settings.....	66
Changing the Manual Call Forwarding Settings.....	66
Changing Your Station Passcode .....	67

---

## **Messages** **69**

<b>Leaving Messages at Other Extensions .....</b>	<b>69</b>
<b>Viewing and Responding to Messages .....</b>	<b>70</b>
Canceling Messages Left at Other Extensions .....	70
Deleting Waiting Inter-Station Messages.....	70
<b>Using Do-Not-Disturb (DND).....</b>	<b>71</b>
<b>Using Reminder Messages.....</b>	<b>72</b>
<b>Paging Other System Users .....</b>	<b>73</b>
Placing a Page Announcement .....	73
Enabling or Disabling the Page Feature .....	73

---

## **Hunt Groups** **75**

<b>Logging in to ACD Hunt Groups .....</b>	<b>75</b>
<b>Logging out of ACD Hunt Groups .....</b>	<b>76</b>
<b>Stopping the ACD Hunt Group Wrap-up Timer.....</b>	<b>76</b>
<b>Other Hunt Group Features .....</b>	<b>77</b>
Requesting Agent Help .....	77

Diverting Hunt Group Calls . . . . .	77
<b>Hunt Group Supervisor Features . . . . .</b>	<b>78</b>
Accepting or Rejecting Agent Help Calls . . . . .	78
Monitoring Calls . . . . .	78
Stealing Hunt Group Calls . . . . .	78
Using Barge-In . . . . .	79

---

## **Cordless Devices 81**

---

<b>Cordless Module . . . . .</b>	<b>83</b>
<b>Handset and Headset Combinations . . . . .</b>	<b>83</b>
<b>Pairing the Cordless Module and Devices . . . . .</b>	<b>84</b>
Pairing a DECT Cordless Accessory with a DECT Cordless Module . . . . .	84
Pairing a Bluetooth Accessory with a Bluetooth Module . . . . .	84
To unpair a cordless device: . . . . .	85
Cordless Module LED Indicators . . . . .	85
<b>Using a Cordless Device as a Remote Control . . . . .</b>	<b>86</b>
<b>Using the Mute Key on a Cordless Device . . . . .</b>	<b>86</b>
<b>Using the Volume Keys on Cordless Device . . . . .</b>	<b>86</b>
<b>Alerting Tones and LEDs . . . . .</b>	<b>86</b>
<b>Low Battery Level . . . . .</b>	<b>87</b>
<b>Using the Mitel Cordless Handset . . . . .</b>	<b>88</b>
Cordless Handset Features . . . . .	88
Answering Calls . . . . .	89
Hanging Up . . . . .	89
Cordless Handset Alerting Tones and LEDs . . . . .	89
<b>Using the Mitel DECT Cordless Headset . . . . .</b>	<b>91</b>
Cordless Headset Features . . . . .	91
Answering Calls . . . . .	91
Hanging Up . . . . .	91
Cordless Headset Alerting Tones and LEDs . . . . .	92
<b>Using A Bluetooth Headset . . . . .</b>	<b>93</b>
Answer a Call . . . . .	93
Hang Up . . . . .	93
<b>Using the Cordless Devices Application . . . . .</b>	<b>94</b>
Viewing Cordless Module Information . . . . .	94
Low Battery Level . . . . .	94
Enabling/Disabling Auto-Connect on a Bluetooth Headset . . . . .	94
Connecting/Disconnecting a Bluetooth Headset . . . . .	94
Editing a Bluetooth Headset Name . . . . .	95

<b>Contact Information.....</b>	<b>97</b>
<b>Error Messages .....</b>	<b>97</b>
<b>Troubleshooting Tips .....</b>	<b>98</b>

---

# Getting Started

## Welcome

The instructions in this guide are for using the Mitel 5360 Internet Protocol (IP) Phone on the MiVoice Office 250. The *Quick Reference Guide* located at the beginning of this guide is an overview of frequently used features.

Your IP phone should be powered on and ready to use. If the display is blank, or if the display name, extension number, or time or date are incorrect, contact your system administrator for assistance.

Because a variety of voice mail products work with the MiVoice Office 250, this guide does not include voice mail instructions. For voice mail instructions, refer to the voice mail user guide for your system. For example, refer to the *Enterprise Messaging, Unified Voice Messaging, and Embedded Voice Mail Card User Guide*, part number 835.3205, or the *Mitel NuPoint Unified Messaging User Guide* on the [Mitel Web site](http://edocs.mitel.com) (<http://edocs.mitel.com>). Contact your system administrator for more information about your voice mail system.

**NOTE**

Because many phone features can be programmed to perform various tasks, some features may work differently than the descriptions in this guide. Contact your system administrator for more information.

## About Your IP Phone

The 5360 IP phone has a seven-inch (17.8 cm), backlit, high-resolution (800 x 480), color, touch-screen display with brightness controls. For one-touch feature access, the 5360 has eight context-sensitive softkeys and 42 self-labeling programmable keys (three pages of 14 each). It includes an embedded screen saver application and text size control.

The Gadget Sidebar provides one-touch access to embedded applications (such as turning the display's backlight on or off). And, a 10/100/1000 auto-sensing Gigabit Ethernet LAN connection allows unconstrained bandwidth from the network to the desktop. The phone supports the Mitel Cordless Handset and Headset, the Mitel Line Interface Module, the Mitel 5310 IP Conference Unit, and the Mitel Wireless LAN Stand.

## 5360 IP Phone Features

The 5360 IP Phone is shown here.<sup>1</sup> See “[Phone Feature Descriptions](#)” below for more information about the phone features.



- 1 – Handset (see [page 3](#))
- 2 – Display and Softkeys (see [page 3](#))
- 3 – Status Bar (see [page 3](#))
- 4 – Gadget Sidebar (see [page 3](#))
- 5 – Ring/Message Indicator (see [page 3](#))
- 6 – Feature buttons (see [page 5](#))
- 7 – Dialpad buttons (see [page 5](#))
- 8 – Programmable buttons (see [page 6](#))
- 9 – Navigation buttons (see [page 6](#))
- 10 – External Speaker (see [page 6](#))

1. This image is an example of how your phone may be programmed.



## Phone Feature Descriptions

The following sections describe default configurations. Your IP phone may be programmed differently. Contact your system administrator for more information. See “5360 IP Phone Features” on [page 2](#) for phone feature locations.

### Handset

The handset provided with this equipment is hearing aid compatible (HAC). If you are using a headset or if you are in Handsfree Mode, you do not need to use the handset. See “Cleaning Your IP Phone” on [page 8](#) and “Using Handsfree Mode” on [page 41](#) for more information.

### Display and Softkeys

The display provides a 800 x 480 (pixels) high-resolution viewing area for selecting and using features and identifying callers. For one-touch feature access, the 5360 has eight context-sensitive softkeys (four on the left and four on the right). When idle, the display shows user information, the system time and date, and feature button assignments. Consider the following when using the display:

- You can adjust the display Brightness levels (see [page 16](#)).
- You can control the size of the text that appears on the display for programmable buttons (see [page 18](#)).

The 5360 IP Phone includes an embedded screen saver that you can configure for your display. Configuration options include the screen saver timeout, display image, and brightness options (see [page 19](#)).

### Status Bar

The status bar displays time, date, and icons indicating feature states as follows:

- **Call Forward All Calls** (📞) – Indicates Call Forward All Calls is activated.
- **Message Waiting** (📧) – Indicates new voice mail.
- **Headset** (🎧) – Indicates that the phone is in headset mode.
- **DND** (🚫) – Indicates that the phone is in DND (Do-Not-Disturb) mode.
- **Conference Unit** (👥) – Indicates that the 5310 IP Conference Unit is connected and turned on.

### Gadget Sidebar

The Gadget Sidebar provides one-touch access to embedded applications. The 5360 IP Phone currently supports the following applications:

- **Backlight On/Off** (💡): Turns the backlight on and off (see [page 16](#)).
- **Call History** (📞): Displays a list of the calls you have missed, made, and answered (see [page 20](#)).
- **Help** (❓): Provides access to Quick Help and displays a list of the key icons (see [page 31](#)).
- **People** (👤): Adds, deletes, edit contact names and numbers (see [page 22](#)).
- **Phone/Home** (📞): Returns to the main Phone/Home window.

You may have additional applications available for customized use. If so, they will appear on the the Gadget Sidebar.

### Ring/Message Indicator











The Ring/Message Indicator flashes or stays lit to indicate call, message, and feature activity. For more information about messaging features, see “Messages” on [page 69](#). Ring/Message

Indicator signals are described in the following table.

Indicator Signals	Description
Rapidly flashing	You have an incoming call.
Slowly flashing	You have a waiting message or callback message.
On	You are on a call or using a feature.
Off	Your IP phone is idle.

## Feature Buttons

Feature buttons provide quick access to commonly used features. See the following table for descriptions.

Button	Action
 (Up) or  (Down)	Provides volume control for the ringer, handset, and speaker. Scrolls through feature options.
 (Speaker)	Activates Handsfree Mode/speakerphone (see <a href="#">page 43</a> ). Activates features.
 (Mute)	Temporarily turns off your microphone during a call.
 (Applications)	Activates the Applications menu to perform the following options: <ul style="list-style-type: none"> <li>• Call History (see <a href="#">page 20</a>)</li> <li>• Use the conference unit (see <a href="#">page 9</a>)</li> <li>• Program the following settings in the Settings application: <ul style="list-style-type: none"> <li>○ Change the language on the display (see <a href="#">page 17</a>).</li> <li>○ Change the text size on the display (see <a href="#">page 18</a>)</li> <li>○ Adjust the display brightness (see <a href="#">page 16</a>)</li> <li>○ Use the screen saver (see <a href="#">page 19</a>)</li> <li>○ Specify audio feedback options (see <a href="#">page 23</a>)</li> <li>○ Calibrate the display (see <a href="#">page 23</a>)</li> <li>○ View phone information (see <a href="#">page 8</a>)</li> </ul> </li> <li>• Use cordless devices (see <a href="#">page 81</a>)</li> <li>• Enable Clean Mode (see <a href="#">page 8</a>)</li> </ul>
 (Special)	Activates features while on a call. The  (Special) button does not cancel features. To cancel features, press the Star button (*).
 (Redial)	Calls the last <i>external</i> number dialed. You cannot redial internal numbers.
 (Hold)	Places the current call on hold and retrieves a call from hold. Left/backspace when entering dialpad characters (see <a href="#">page 24</a> ).
 (Transfer)	Transfers the current call. Right/forward when entering dialpad characters (see <a href="#">page 24</a> ).
 (Message)	Displays station messages. Toggles between Alpha Mode and Numeric Mode when entering dialpad characters.

## Dialpad Buttons

Use the dialpad buttons to dial phone numbers, enter feature codes, and to enter characters when using features that require text input.

### Programmable Buttons

The 5360 IP Phone has 42 self-labeling programmable keys using a touch-screen display (three pages of 14 each). Each phone has the following buttons that are programmed by the system administrator and cannot be reprogrammed; however, you can program the remaining buttons for quick access to features or speed-dial entries. See “Using Programmable Buttons” on [page 24](#).

Button	Action
DND	Turns DND mode on or off.
Outgoing	Selects an outgoing line for external calls.
Call Key 1	Selects an outside line or answers a call.
Call Key 2	Selects an outside line or answers a call.
IC	Answers an intercom (internal) call.
Conference	Places a conference call.
Forward	Forwards the call to the specified number.

### Navigation Page Buttons

The 5360 IP Phone has three Navigation Page icons located in the bottom right hand corner of the display to navigate between the IP phone’s three display pages. When a page icon in the bottom right-hand corner of the Display blinks, it means that there is real-time activity on the page where the number or feature is located.

If you navigate to the second or third pages, you must use the Navigation Page buttons to return to the first page. You are not automatically returned to the first page after using features or when the IP phone is idle. You can also press the  (Home) button on the 5360 IP Phone (only) to return to the first page.

### External Speaker

The speaker provides audio for handsfree calls and background music. See “Using Handsfree Mode” on [page 43](#) for information about handsfree calls. See “Listening to Background Music” on [page 30](#) for more information about background music.

---

## Phone Signals

The 5360 IP Phone has several audio and visual signals to indicate feature activity. The following are a few helpful tips:

- Lit or blinking buttons indicate call or feature activity.
- All phone button lamps illuminate at the same time for a few seconds when the IP phone is reset or powered on.
- The following actions may cause an error tone:
  - Pressing an invalid button combination.
  - Selecting a restricted feature.
  - Dialing a restricted or invalid number.
  - Dialing too slowly between digits.
  - Waiting too long before performing the next step.To correct an error tone, hang up and try again.
- Many features “time-out” if you wait too long before performing the next step. If this happens, you must start over.
- “Off-hook” means the handset is lifted. “On-hook” means the handset is in the cradle.
- If your IP phone does not have a lamp under the speaker button, the large message indicator lamp on the top right of the IP phone indicates that the speakerphone is in use.

## Comfort and Safety Tips

Observe the following comfort and safety tips when using the IP phone:

- **Do not cradle the handset:** Prolonged use of the handset can lead to neck, shoulder, or back discomfort, especially if you cradle the handset between your neck and shoulder. If you frequently use the IP phone, you might find a headset more comfortable. “Using a Headset” on [page 8](#).
- **Adjust the viewing angle:** The built-in stand tilts to give you a better view of the buttons. See “Adjusting the Viewing Angle” on [page 15](#).
- **Protect your hearing:** Because prolonged exposure to loud sounds can contribute to hearing loss, keep the volume at a moderate level. You can adjust the volume levels of the handset receiver or headset. See “Changing Volume Levels” on [page 16](#).

## Viewing the Phone Information

You can use the phone to view system or phone information.



### To view system information:

1. Press  (Applications).
2. Press **Settings**, and then press **About 5360 IP Phone**. The About menu appears.
3. Press **X** (Close) to exit the About menu, and then press **Close** to exit the Applications menu.



## Cleaning Your IP Phone

You can wipe and clean the touch screen of your 5360 IP Phone without causing touch-sensitive controls to be activated.

### To enable Clean Mode when you clean the screen of your phone:

1. Press  (Applications).
2. Press **Clean Mode**.
3. Clean the screen of your phone.
4. Press  (Applications) to end Clean Mode.

## Using a Headset

When using a headset, press  (Speaker) to connect to or disconnect from calls. The Headset icon  appears when the headset is in use. You cannot use the handset or speakerphone when the IP phone is in Headset Mode. Disconnecting the headset automatically enables the handset.

### NOTES

The headset must be hearing aid compatible (HAC).

If your headset has a power-saver mode, make sure the system administrator has enabled the “Headset Connect Tone” feature. If this is not enabled, you may miss the first few seconds of an incoming call.

### To connect and activate the headset:

1. Insert the headset jack into the Headset port  located on the back of the IP phone.
2. Dial **317** (Headset on/off). HEADSET MODE ON appears.

### NOTE

Because Headset Mode disables the handset and speakerphone, you must turn off Headset Mode before you can use the handset or speakerphone.

### To turn off Headset Mode and activate the handset and speakerphone:

Dial 317 (Headset on/off). HEADSET MODE OFF appears.

## Using the 5310 IP Conference Unit

Your IP phone can use the 5310 IP Conference Unit (shown below) for full-duplex, advanced IP conferencing. Use the Conference Controller touch screen to turn the Conference Unit on or off, to adjust the volume or to put the Conference Unit into Presentation mode. You can only run one Conference Controller session at a time. If the 5310 Conference Unit is not connected to your IP phone, the Conference Controller application is not available.

Installation instructions are included with the unit.

*Mitel 5310 IP Conference Unit*



For information about placing conference calls and adding parties to the conference, see “Placing Conference Calls” on [page 47](#).

### Accessing/Exiting the Conference Controller Application

You must first access the Conference Controller application to use the Conference Unit.

**To access the Conference Controller application:**

1. Press  (Applications).
2. Press **Conference Unit**.

**To exit the Conference Controller application:**

Press **Close** in the Conference Controller application.

### Turning the Conference Unit On and Off

The following instructions describe how to turn the Conference Unit on and off.

**To turn the Conference Unit on and off:**

Press **Turn On** or **Turn Off** in the Conference Controller application. If applicable, the  icon appears in the IP phone status line while the Conference Unit is on.

#### NOTE

Turning the 5310 Conference Unit off terminates the active call. To continue the call either pick up the handset or press the **Speaker** button on the IP phone.

### Adjusting the Conference Unit Volume

The following instructions describe how to adjust the Conference Unit volume.

**To adjust the Conference Unit volume:**

Press **Volume Up** or **Volume Down**.

### Muting the Conference Unit

You can mute the Conference Unit so that conversation or noise near the Conference Unit cannot be heard by individuals being conferenced.

#### To mute the Conference Unit:

Press **Mute**.

### Placing the Conference Unit in Presentation Mode

Presentation Mode should be used when only one individual will be speaking into the Conference Unit. If another individual near the unit wishes to speak, you should disable Presentation Mode. Presentation Mode minimizes extraneous noise.

#### To enable/disable Presentation Mode:

Toggle **Presentation Mode** on or off in the Conference Controller application.



## Using the Line Interface Module (LIM)

The LIM is an optional device that adds an analog phone line capability to your IP phone. In the event of a network failure, the IP phone can be configured to use the public switched telephone network (PSTN) to provide continued basic telephony until service is restored. The analog line can also be used for emergency calls and local calling.

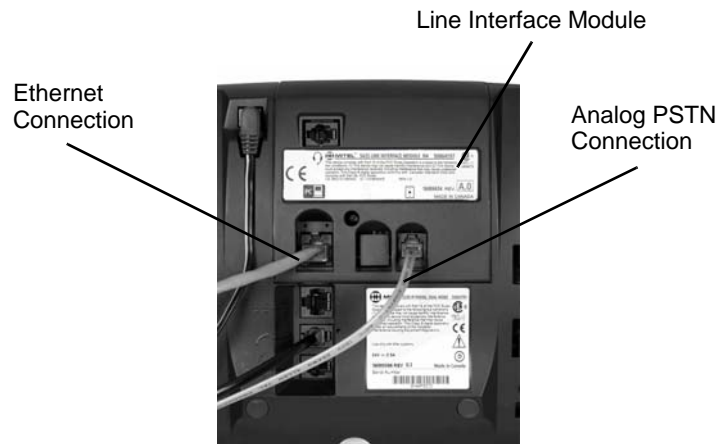

You can use the LIM to:

- allow incoming and outgoing analog PSTN calls directly to and from the IP phone
- provide survivability (failover) in the event IP connectivity is lost
- provide emergency dialing support (emergency calls can be programmed to connect through the analog PSTN connection)

If you have a LIM connected to your IP phone, all programming of the LIM, except the Analog button (key), is done by the Installer when your IP phone is installed. To program the Analog button, see “Using Programmable Buttons” on [page 24](#).

The LIM operates in one of the following two modes, as determined by your System Administrator:

- **LIM Mode:** You can use the LIM line at any time.
- **Failover Mode:** You can use the LIM line only when the IP connection has failed.

---

**NOTE** Handsfree and on-hook dialing are not supported on the LIM line.

For information on emergency number dialing using the LIM, see “Placing Emergency Calls using the LIM Line” on [page 33](#).

## Making and Answering Calls Using the Analog Button

### To make a call using the Analog line:

1. Lift the handset.
2. Press the button you programmed as **Analog Line**. ANALOG CALL appears.
3. Dial the number.

#### NOTE

When you make an external call over the analog line, a prefix dialing number is not required. If your IP phone's Analog Line button has the Privacy option enabled, you cannot access the analog line when another phone is using the analog line (button is solid orange). To access the analog line, the user of the other phone must first hang up. To determine whether the Privacy option is enabled, contact your System Administrator.

### To answer a Call using the analog line:

1. Lift the handset.
2. Press the **Analog Line** button that is highlighted.

### To answer a waiting call on the analog line:

#### NOTE

If you have subscribed to an analog call waiting service, you may use the hookswitch or press the Star button (\*) to answer a waiting analog call. When you are on an analog call and a waiting analog call arrives, you hear a beep. This feature may not be supported in all regions.

### To answer a waiting analog call or return to the original analog call:

1. Do one of the following:
  - Press and release the hookswitch.
  - Press the Star button (\*) to cancel.
2. Press the button you have programmed as **Analog Line**.

### To put a current call on hold to answer an incoming analog call:

Press the highlighted **Analog Line** button.

### To switch between the current call and the held call when one of the calls is using the analog line, do one of the following:

- If your current call is using the analog line, press the flashing **Line** button of the held call. The analog call is automatically put on hold.
- If your current call is using an IP line, press the highlighted **Analog Line** button. The IP line is automatically put on hold.

### To end a current call when an incoming analog call arrives:

Press the Star button (\*) and then press the highlighted **Analog Line** button. The current call ends and you are connected to the caller on the analog line.

### To end the current analog call when an incoming call arrives:

Press the Star button (\*) to cancel. The current analog call ends and you are connected to the new caller.

## Making and Answering Calls Using the Failover Mode

**To make a call using the analog line during an IP connection failure:**

1. Lift the handset. IP FAIL: ANALOG CALL appears.
2. Dial the number.

**To answer a call using the analog line during an IP connection failure:**

Lift the handset. The call is answered. IP FAIL: ANALOG CALL appears.



# Personalizing Your Phone

This chapter describes features you can use to personalize your IP phone.

## Adjusting the Viewing Angle

You can tilt the IP phone stand for a better view of the buttons and display.

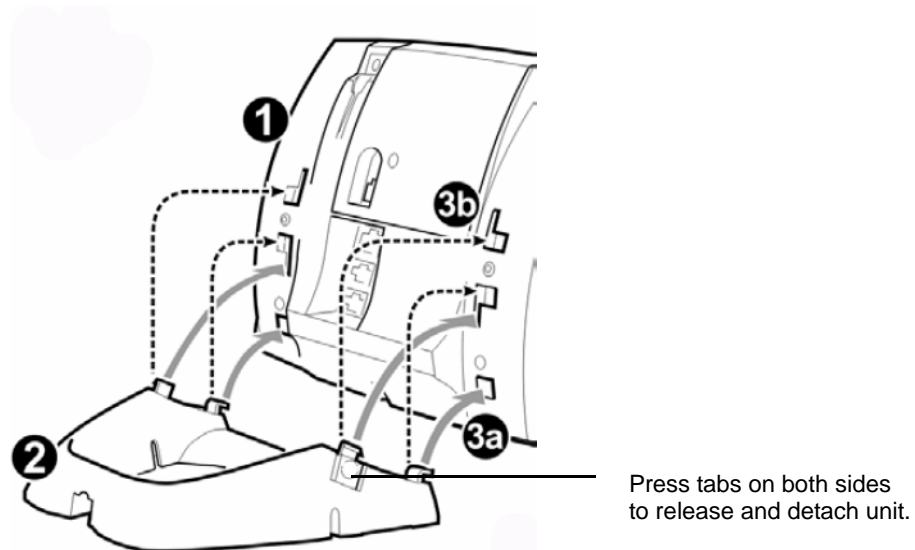

### To adjust the viewing angle:

1. Turn the IP phone so it faces away from you.
2. Hold the base firmly, and then press the tabs on the sides of the stand to release and detach the base unit.
3. Hinge the hooks on the base unit into the notches on the back of the IP phone, and then snap into place as follows:
  - For a *high-angle mount*, hinge the two lower hooks into the bottom set of notches, and then snap the two upper hooks into the middle set of notches.
  - For a *low-angle mount*, hinge the two lower hooks into the middle set of notches, and then snap the two upper hooks into the top set of notches.

## Changing Volume Levels

You can change the following volume levels:

- Ringer (alerting tone)
- Handset
- Headset
- Background music
- External speaker

### NOTE

Turning the external speaker volume down to the lowest levels may prevent you from hearing the feature “warning tones” that notify you when errors occur (for example, when you enter an incorrect feature code).

You must be using the feature to change the volume level. For example, if you want to change the handset volume level, you must be using the handset. However, you can adjust the ringer (alerting tone) volume level when the IP phone is idle.

### To change a volume level:

While using the feature, press ▲ (Up) to increase the volume, or press ▼ (Down) to decrease the volume. The volume level is automatically saved.

## Changing the Ring Tone

You can select one of nine different ring tones.

### To change the ring tone:

1. With the handset on-hook, dial **398**.
2. Do one of the following to listen to (or turn off) ring tones:
  - Press **0** or the **RINGER OFF** menu button to turn the ringer off.
  - Press (Up) or (Down) or **1** to **9** to listen to ring tones.
  - Press the **PREVIOUS** or **NEXT** menu button to listen to and select a ring tone.
3. Press  (Speaker), **#**, the **ACCEPT** menu button, or lift and replace the handset to select the ring tone.

## Adjusting the Display Brightness

You can adjust the display Brightness levels.

### NOTE

By default, the IP phone display dims to 20 percent of the maximum brightness level after 5 minutes of inactivity (no button presses or audio, including background music). If the brightness is set at the lowest level, you may not notice when the display dims.

### To adjust the Brightness level:

1. Press  (Applications).
2. Press **Settings**, and then press **Brightness**.
3. Press **(Brightness) +** or **-** to find the level you want to use.
4. Press **#** or **Save** to save the setting, and then press **Close** to exit the Applications menu.

## Changing the Language

You can change the language in which phone prompts and applications appear. Supported languages are American English, British English, Canadian French, and Mexican Spanish.

The system can support up to four languages at one time. The language choices appearing on your display are controlled by system programming.

### To change the display/prompt language:

1. Press  (Applications).
2. Press **Settings**, and then press **Languages**.
3. Press the language that you want to use.
4. Press **#** or **Save** to save the setting, and then press **Close** to exit the Applications menu.

## Changing the Text Size on the Display

You can control the size of the text that appears on the display for programmable buttons. This enhancement does not apply to the text size that appears on the display for the menu buttons.

Text size options include:

- **Small text** (default): Provides a first line of basic information and a second line of supplemental information for the features and functions programmed for the button.
- **Large text**: Provides one line of basic information for the features and functions programmed for the button. Large text is enabled by default.

The table below includes several examples for the small text and large text display options.

Programmable Button	Small Text Example	Large Text Example	Second line provides:
Station Speed Dial	Monica S 25598	Monica S	The station speed-dial number programmed for the button.
System Speed Dial	Chandler TS 4809619000	Chandler TS	The system speed-dial number programmed for the button.
Programmable Key Module (PKM)	Jessica A	Jessica A 28899	The extension number programmed for the user.
Programmable Feature	DND (372)	DND	The feature code that corresponds to the feature programmed for the button.
Intercom Call (IC)	IC Charlie B	IC	The name or number for the other party on the internal call.

### To change the text size on a display:

1. Press  (Applications).
2. Press **Settings**, and then press **Text Size**.
3. Press **Large Text** or **Small Text**.
4. Press **Save**, and then press **Close** to exit the Applications menu.



## Using the Screen Saver

The IP Phones include an embedded screen saver that you can configure for your display.

By default the screen saver image is disabled. When your IP phone enters screen saver mode, only the IP phone's backlight dims. The 5360 IP Phone has a backlit display.

You can enable the screen saver image and when your IP phone enters screen saver mode, the IP phone's backlight dims and the embedded nature screen saver images appear on your display. The images are not changeable.

### To configure the screen saver on your IP Phone:

1. Press  (Applications).
2. Press **Settings**, and then press **Screen Saver**. The Screen Saver menu appears.
3. Configure your screen saver options:
  - a. Select one of the following screen saver timeout options:
    - o 15 minutes
    - o 10 minutes
    - o 5 minutes
    - o 1 minute
  - b. If desired, enable the **Display Image** option:
    - o *If you enable the Display Image option*, the screen saver image appears and your backlight dims when your IP phone enters screen saver mode, as specified by the screen saver timeout setting.
    - o *If you disable the Display Image option*, only your backlight dims (if your IP phone has a backlight) when your IP phone enters screen saver mode, as specified by the screen saver timeout setting. This is the default setting.
  - c. Configure brightness options if your IP phone has a backlight.

Options include:

    - o **Brightness+**: Increases the brightness of the display when your IP phone is in screen saver mode.
    - o **Brightness-**: Decreases the brightness of the display when your IP phone is in screen saver mode.
    - o **Show Brightness**: Shows the brightness level of the display when your IP phone is in screen saver mode. The display returns to normal after approximately two seconds.
4. Press **Save**.
5. Press **Close** to exit the Applications menu.

### To wake your IP phone from screen saver mode:

Lift the handset or press any button to wake the IP phone.

## Viewing Call History

You can use the Call History application to display a list of the calls that you have missed, made, and answered. The list shows your most recent 50 calls. After the 50-call limit has been reached, the oldest call record is replaced each time a new call is missed, made, or answered.



From this application, you can:

- display calls by type
- display call information (if available) for each call
- return missed calls by pressing a button
- delete or modify digits before saving or dialing a call
- delete calls

### Viewing Call History

You can use the Call History application to filter the call records and display information on each call in the list.

#### To view your call history:

1. Press the **Call History** icon () located on the Gadget Sidebar.
2. Press:
  - **Missed** to view your missed calls (if any).
  - **All** to view a list of all call records.
  - **Answered** to view your incoming calls.
  - **Made** to view your outgoing calls.
3. Use the navigation buttons at the bottom of the display to move to the previous or next page of call records. The total number of pages in the current list is shown at the bottom of the display.
4. Press the **Dial** icon () to the right of the call record to call the contact, or press on a call record to display the call details:
  - Name and number (if available)
  - Call type (for example, Missed)
  - Time and date of call
5. Do one of the following:
  - If necessary, use the keypad cursor left, cursor right, Delete, and Backspace keys to modify the number. Press **Dial** to call the number or press **To People** to save the contact details to the People application.
  - Use the navigation buttons at the bottom of the display to show details for another call record.

Press **Close** to return to the previous list.

## Deleting Call Records

You can delete individual call records or all calls of a certain type.

### To delete an individual call record:

1. Press the **Call History** icon () located on the Gadget Sidebar.
2. Press the button to the left of the call to display the call details
3. Press **Delete**.



### To delete all calls by type:

1. Press the **Call History** icon () located on the Gadget Sidebar.
2. Press:
  - **Missed** to view your missed calls (if any).
  - **All** to view all calls.
  - **Answered** to view your incoming calls.
  - **Made** to view your outgoing calls.
3. Press **Delete List** to delete all calls from the currently displayed list.
4. You are prompted to confirm the delete. Press **Delete**.

## Reviewing Call Record Icons

The Help application available on certain 53xx IP phones has an Icons section that explains the meaning of the various call record icons.

### To view the help about the call record icons:

1. Press the **Help** icon () located on the Gadget Sidebar.
2. Press **Icons**.
3. Press  or  to navigate to the list of Call History icons.

## Customizing Your Contact List

You can use the People application on the 5360 IP Phone to add, delete, and edit contact names and numbers. You can also dial anyone on your contact list from the People application. The People window displays up to eight contacts per page, ordered alphabetically by last name.

### Adding Names to Your Contact List

You can add a name to your contact list by entering it directly using the People application or by copying a number using the To People from the Call History application.

#### To add a name to your contact list using the People application:

1. Press the **Contact List** icon (  ) located on the Gadget Sidebar.
2. Press **New**.
3. Enter the name using the on-screen keyboard to press the appropriate letters to spell the name of your contact.
4. Press **Edit Number** and using the on-screen numeric keyboard or the keypad, enter the number. If an outgoing prefix is required to access an external line, you may need to add the digit(s).
5. Press **Save**.
6. Press **Close**.

### Editing Your Contact List

If necessary, you can edit existing names and/or numbers in your People application contact list.

#### To edit contact information using the People application:

1. Press the **Contact List** icon (  ) located on the Gadget Sidebar.
2. Press the name you wish to edit. (If you wish to delete the name from your contact list, press **Delete**.)
3. Press **Edit...**
4. Using the on-screen keyboard, update the appropriate information for the name.
5. Press **Edit Number**, and using the on-screen numeric keypad, edit the number.
6. Press **Save**.
7. Press **Close**.

### Dialing from Your Contact List

You can dial a phone number associated with a contact name in your People application list.

#### our People application list:





1. Press the **Contact List** icon (  ) located on the Gadget Sidebar.
2. Use the navigation buttons to page through the contact list and select the desired name.
3. Dial the contact name using one of the following methods:
  - Select a contact name and press **Dial**.
  - Press the dial icon to the right of the contact's name in the main list. (The contact name does not need to be selected.)
4. Continue the call using the speakerphone, or lift the handset for privacy.

## Specifying Audio Feedback Options

The Audio Feedback setting allows you to adjust the volume of the audio feedback as well as the error beeps, and enable or disable the setting.

The error beep volume in the phone is related to the volume of the speaker. You can set the beep volume using this procedure; however, adjusting the speaker volume also affects the beep volume.

### To adjust the volume of the audio feedback:

1. Press  (Applications).
2. Press **Settings**, and then press **Audio Feedback**.
3. Set the audio feedback options for the button beep and error beep.
  - To turn audio feedback on or off, press  or .
  - To adjust the volume level, press  or .
  - To play the beep, press **Play button beep** or **Play error beep**.
4. Press **Save**.
5. Press **Close** to exit the Applications menu.

## Calibrating the Display

You can calibrate the touch display for optimum touch sensitivity.





### To calibrate the phone screen for touch accuracy:

1. Press  (Applications).
2. Press **Settings**, and then press **Calibrate Display**.
3. Touch the center of each + to calibrate the display.
4. Press **OK**, and then press **Close**.

## Using the Dialpad Buttons to Enter Characters

You can use the dialpad buttons to enter text or numbers for features such as Do-Not-Disturb (see [page 71](#)) and Station Speed Dial (see [page 38](#)).

The following are guidelines when entering dialpad characters:

- Press  (Message) to switch from Alpha Mode to Numeric Mode. The  (Message) button stays lit in Alpha Mode and is off in Numeric Mode.
- Press  (Hold) to move the cursor to the left and delete characters.
- Press  (Transfer) to move the cursor to the right.
- In Numeric Mode, press # for a hyphen (-).
- In Numeric Mode, press \* for a colon (:).
- Press #, , or lift and replace the handset to save entries.





### To use the dialpad to enter characters:

Press the dialpad buttons as shown in the following table.

**Dialpad Characters — American English and British English**

Button	Number of Times Dialpad Button is Pressed														
	1	2	3	4	5	6	7	8	9	10	11	12	13	14	15
1	:	-	/	,	.	;	( )	&	+	*	!	?	#	1	
2	A	B	C	2	a	b	c								
3	D	E	F	3	d	e	f								
4	G	H	I	4	g	h	i								
5	J	K	L	5	j	k	l								
6	M	N	O	6	m	n	o								
7	P	Q	R	S	7	p	q	r	s						
8	T	U	V	8	t	u	v								
9	W	X	Y	Z	9	w	x	y	z						
0	0														

For example, to enter **May 31**, you could use the following sequence:

1. In Alpha Mode ( [Message] button is lit), press **6** once to enter an “M.”
2. Press **2** five times to enter an “a.”
3. Press **9** eight times to enter a “y.”
4. Press  (Transfer) to enter a space.
5. Press  (Message) to switch to Numeric Mode.
6. Press **3**.
7. Press **1**.
8. Press , #, or lift the handset to save the entry.

The following tables show the dialpad characters for the Canadian French and Mexican Spanish languages.

**Dialpad Characters — Canadian French**

	Number of Times Dialpad Button is Pressed														
Button	1	2	3	4	5	6	7	8	9	10	11	12	13	14	15
1	:	-	/	,	.	;	( )	&	+	*	!	?	#	1	
2	A	B	C	2	A	b	c	À	Â	Æ	Ç	à	â	æ	ç
3	D	E	F	3	D	e	f	È	É	Ê	Ë	è	é	ê	ë
4	G	H	I	4	G	h	i	Î	Ï	î	ï				
5	J	K	L	5	J	k	l								
6	M	N	O	6	M	n	o	Ô	Œ	ó	œ				
7	P	Q	R	S	7	p	q	r	s						
8	T	U	V	8	T	u	v	Ù	Û	Ü	ù	û	Û		
9	W	X	Y	Z	9	w	x	y	z	ÿ	ÿ				
0	«	»	0												

**Dialpad Characters — Mexican Spanish**

	Number of Times Dialpad Button is Pressed														
Button	1	2	3	4	5	6	7	8	9	10	11	12	13	14	15
1	:	-	/	,	.	;	( )	&	+	*	!	?	#	1	
2	A	B	C	2	A	b	c	Á	Á						
3	D	E	F	3	D	e	f	É	é						
4	G	H	I	4	G	h	i	Í	í						
5	J	K	L	5	J	k	l								
6	M	N	O	6	M	n	o	Ñ	Ó	ñ	ó				
7	P	Q	R	S	7	p	q	r	s						
8	T	U	V	8	T	u	v	Ú	Ü	ú	ü				
9	W	X	Y	Z	9	w	x	y	z						
0	í	¿	ª	º	0										

## Using Programmable Buttons

For quick access, you can assign feature codes, extensions, speed-dial numbers, trunks, or other resources to your programmable buttons. The new button assignments are self labeled, which means the button labels automatically appear on the Display when the buttons are programmed. You can then press the programmed buttons to activate features or place calls. See “Default Access Codes” and “Default Feature Codes” on [page 27](#) for code lists. You cannot reprogram the default button assignments. See “Programmable Buttons” on [page 6](#).

### To program a button:

1. With the handset on-hook, dial **397**.
2. Press the button that you want to program. If the button is:
  - *not programmed*, UNDEFINED KEY appears.
  - *programmed*, the feature or extension programmed for the button appears.
  - *not programmable*, NON-PROGRAMMABLE KEY appears.
3. Enter the feature code, extension number, station speed-dial number, or system speed-dial number to be assigned to the button. To assign speed-dial numbers to programmable buttons, see “Assigning Speed-Dial Numbers to Programmable Buttons” on [page 40](#).

#### NOTE

Before or after assigning the speed-dial number to a programmable button, make sure the speed-dial number has either a Station Speed Dial bin or System Speed Dial location assigned to it. For System Speed Dial numbers, numbers are pre-assigned to the System Speed Dial locations (000 to 999) by your system administrator. Therefore, you just need to choose a System Speed Dial location that you want to use (see “Using System Speed Dial” on [page 38](#) for details). For Station Speed Dial numbers, you must manually store numbers in the Station Speed Dial bins (0 to 9). See “Using Station Speed Dial” on [page 38](#).

After you program a button, you can:

- Press the button to place a call to the assigned extension.
- Press the button and then hang up to transfer a call to the assigned extension. If the call is transferred to voice mail you hear repeating double tones.
- Visually monitor the call activity of the assigned extension if the button you assign has a lamp.

The following table describes the lamp signals and the indicated call activity for a PKM button (station speed-dials do not show status).

Lamp Signals	Description
Continuously Lit	The extension is busy or off-hook.
Slowly flashing	The extension is in Do-Not-Disturb (DND).
Quickly flashing	The extension has a call ringing in.
Continuously flashing	The extension is causing a “Station Off-Hook” system alarm.



## Default Access Codes

The following are default system access codes. If your system uses different codes, record the codes in the “New Code” column for reference.

### Outside Line Access Codes

Code Type	Code	New Code
Emergency Call	911 (999/112 Australia and Europe)	
Outgoing Call (Default)	8 (0 Australia)	
Select Line Group 1 to 208	92001 to 92208	
Automatic Route Selection	92000	

### Extension Numbers

Code Type	Code	New Code
Attendant	0	
Phone Extensions	1000 to 1999	
Hunt Groups	2000 to 2299	

## Default Feature Codes

The following table lists default feature codes. If your system administrator changes any of the default codes, you can record the new codes in the “New Code” column for reference.

<b>NOTE</b>	Most of the following feature codes work when your IP phone is idle. However, if you are on an active call or if the IP phone is off-hook, you may need to press  (Special) before you enter the feature code to activate the feature.
-------------	---

#### To delete the characters entered:

Press  (Hold) to move the cursor to the left and delete the characters entered.

#### To cancel the feature:

Press \*.

Feature	Page	Code	New Code
Account Code – Follow Calls	<a href="#">42</a>	391	
Account Code – Optional	<a href="#">42</a>	390	
ACD Agent – Log In	<a href="#">75</a>	326	
ACD Agent – Log In/Out	<a href="#">75</a>	328	
ACD Agent – Log Out	<a href="#">75</a>	327	
ACD Agent – Wrap-up Terminate	<a href="#">76</a>	329	
Activate Door Relay	<a href="#">31</a>	332	
Agent Help – Reject	<a href="#">77</a>	376	
Agent Help – Request	<a href="#">77</a>	375	

Feature	Page	Code	New Code
Answer Ringing Call	33	351	
Automatic IC Access – On/Off	33	361	
Automatic Trunk Access – On/Off	33	360	
Automatic Trunk Answer	34	350	
Background Music – On/Off	30	313	
Barge-In	79	386	
Call Forward – All Calls	48	355	
Call Forward – If Busy	48	357	
Call Forward – If No Answer	48	356	
Call Forward – No Answer/Busy	48	358	
Call Logging	57	333	
Conference	52	5	
Default Station	30	394	
Directory	41	307	
Display Time And Date	47	300	
Do-Not-Disturb	71	370	
Do-Not-Disturb – Cancel	71	371	
Do-Not-Disturb – On/Off	71	372	
Do-Not-Disturb – Override	71	373	
Dynamic Extension Express On	49	363	
Dynamic Extension Express Off	49	362	
Dynamic Extension Express On/Off	49	364	
Dynamic Extension Express Handoff	49	388	
Group Listen	56	312	
Handsfree – On/Off	43	319	
Headset – Off	8	316	
Headset – On	8	315	
Headset – On/Off	8	317	
Hold – Individual	44	336	
Hold – System	44	335	
Hookflash (Recall in Europe)	44	330	
Hot Desk On/Off	59	348	
Hunt Group – Remove	77	322	
Hunt Group – Remove/Replace	77	324	
Hunt Group – Replace	77	323	
Display Contrast Control	16	303	
Message – Cancel Left Message	70	366	

Feature	Page	Code	New Code
Message – Delete Message	70	368	
Message – Leave Inter-station Message	69	367	
Message – View Messages	70	365	
Microphone Mute – On/Off	43	314	
Page	73	7	
Page Receive – On/Off	73	325	
Program Buttons	26	397	
Program Station Passcode	64	392	
Programmable Buttons – Return to Default	30	395	
Queue (Callback) Request	36	6	
Record-A-Call	54	385	
Redial	37	380	
Redirect Call	34	331	
Reminder Message	71	305	
Reminder Message – Cancel	71	306	
Remote Programming	64	359	
Reverse Transfer (Call Pick-Up)	45	4	
Ring Intercom Always – On/Off	43	377	
Ring Tone Selection	16	398	
Station Monitor	78	321	
Station Speed Dial	38	382	
Station Speed Dial – Programming	38	383	
Steal Call	78	387	
System Forward – Off	48	353	
System Forward – On	48	352	
System Forward – On/Off	48	354	
System Speed Dial	38	381	
Switch Keymap	31	399	
Transfer To Hold	45	346	
Transfer To Ring	45	345	
View Programmable Button Assignments	30	396	

## Listening to Background Music

If your system is equipped with a music source, you can listen to background music or system audio (for example, organizational conference calls) through the external speaker.

**To turn on or turn off background music:**

Dial **313** (on/off). BACKGROUND MUSIC ON (or OFF) appears.

## Viewing Button Assignments

You can view programmable button (key) feature assignments.

**To view button assignments:**

1. With the handset on-hook, dial **396**. PRESS THE KEY TO REVIEW appears.
2. Press any of the feature buttons to display the assignment.
3. Press **#** or  (Speaker) to exit.

## Resetting Programmable Buttons

You can reset all buttons (keys) that you have programmed to the default assignments. Resetting the programmable buttons does not reset button assignments programmed by the system administrator.

**To reset the feature buttons to the default values:**

With the handset on-hook, dial **395**. FEATURE KEYS DEFAULTED appears.

## Resetting the IP Phone to the Default Settings

Resetting the IP phone to the default settings does the following:

- Returns all volume settings to the default levels. See “Changing Volume Levels” on [page 16](#).
- Cancels Background Music. See “Listening to Background Music” on [page 30](#).
- Cancels Callback (queue) requests. See “Requesting a Callback (Queuing the Phone)” on [page 36](#).
- Restores Handsfree Mode. “Using Handsfree Mode” on [page 43](#).
- Cancels Manual Call Forwarding. See “Manual Call Forwarding” on [page 48](#).
- Cancels System Forwarding. See “System Forwarding” on [page 48](#).
- Cancels Do-Not-Disturb (DND). See “Using Do-Not-Disturb (DND)” on [page 71](#).
- Restores Page settings. See “Paging Other System Users” on [page 73](#).
- Resets hunt group calls. See “Hunt Groups” on [page 75](#).

**To reset your IP phone to the default settings:**

Dial **394**. STATION DEFAULTED appears.

## Switching Keymaps

Keymaps are the default button assignments on your IP phone. Your system administrator may have programmed an alternate keymap, allowing you to switch between keymap assignments. Contact your system administrator for more information.

### To switch between keymaps when your IP phone is idle:

With the handset on-hook, dial **399**. The display shows either ALTERNATE (or) STANDARD KEYMAP IS ACTIVE.

### To switch between keymaps during a call:

Press  (Special), and then dial **399**.

## Turning the Backlight on or off

You can turn the backlight on or off on your display.

### To turn the backlight on:

Click the Backlight On/Off icon () in the Gadget Sidebar.





### To turn the backlight off:

Click the Backlight On/Off icon () again in the Gadget Sidebar.

## Getting Help

You can access the 5360 IP Phone Help.

### To access the 5360 IP Phone Help:

1. Click the Help icon () in the Gadget Sidebar. The Welcome to the 5360 Help System window appears.
2. Press the information that you want to view, and then do any of the following:
  - To navigate to the previous or next window, press  or .
  - To return to the main Help window, press .
  - To exit, press  once or twice.

## Activating Door Relay

If the Activate Door Relay feature is enabled, you can unlock a door (i.e., “buzz” it open) through your IP phone.

You can enter the Activate Door Relay feature code while idle or while on a call. This allows you to activate the feature while talking to a communications device mounted at the door without first having to hang up. When activated while on a call, the feature will not affect the call in progress other than to show a short confirmation on the display.

You can add the Activate Door Relay feature to a phone keymap button, just like any other station feature.

### To unlock a door:

While idle or while on a call, dial **332**. The door is unlocked.



---

# Answering and Placing Calls

The following instructions describe how to answer and place internal and external calls and how to use related features.

**NOTE**

By default, internal (intercom) calls are assigned to the **IC** button, and external calls are assigned to the **Call Key** buttons.

## Answering Calls

Your IP phone may be preset to automatically answer incoming internal calls in Handsfree Mode. To disable Handsfree Mode, see “Using Handsfree Mode” on [page 43](#). After disabling Handsfree Mode, you can use your handset or headset to answer incoming calls.

**To answer a call:**

Lift the handset, or press  (Speaker) to answer a call while using a headset, or to answer a call in Handsfree Mode. See “Using Handsfree Mode” on [page 43](#).

If you are currently on a call, press the flashing **IC** or **Call Key** button to answer a waiting call. See “[Answering Waiting Calls](#)” below.

## Answering Waiting Calls

If you receive a call while you are on another call, you hear a “call waiting” tone, the **IC** or **Call** button flashes, and the display shows the Caller ID information (if available).

**To answer a waiting call:**

Press the flashing **IC** or **Call Key** button. This action hangs up on the connected call and connects you to the waiting call. You can also place the first call on hold before you answer the waiting call. See “[Placing Calls On Hold](#)” on [page 44](#).

## Using Automatic Call Access

Automatic Call Access connects you to incoming internal or external calls when you pick up the handset or press  (Speaker). When Automatic Call Access is turned off, you must press the flashing **IC** or **Call Key** button to answer incoming calls.

**To use Automatic Call Access for incoming IC calls:**

With the handset on-hook, dial **361** to turn on (or off). AUTO IC ACCESS ON (or OFF) appears.

**To use Automatic Call Access for incoming external (trunk) calls:**

With the handset on-hook, dial **360** to turn on (or off). AUTO TRNK ACCESS ON (or OFF) appears.

### Redirecting Calls

You can redirect calls to another extension or external number. If you have a 5360 IP Phone, you can use the menu buttons to redirect calls to the following destinations:

- **SEND TO V-MAIL:** Sends the call directly to your voice mailbox. You must have a mailbox to use this destination.
- **IC CALL TO DND:** Places your IP phone in DND Mode and blocks the call. See “Using Do-Not-Disturb (DND)” on [page 71](#).
- **SEND TO DEST:** Redirects the call to the extension or phone number entered.

#### To redirect calls:

1. While a call is ringing, dial **331** or press the menu button as described above.
2. Do one of the following:
  - Dial the extension number, or press the **Outgoing** button or the Outgoing Call access code (the default code is **8**), and then dial the external number.
  - Enter the DND code.

### Using Automatic Trunk Answer

You can use Automatic Trunk Answer to answer incoming external calls for other internal parties who are members of an “Answer Access” list. Your system administrator creates Answer Access lists. Contact your system administrator for Answer Access list extensions.<sup>1</sup>

Automatic Trunk Answer answers calls in the order they are received (that is, the first call received by any extension in the Answer Access list is the first one answered).

#### To use Automatic Trunk Answer:

1. While an incoming external call is ringing at another Answer Access list extension, lift the handset or press  (Speaker).
2. Dial **350** or press the flashing **Trunk <number>** button.

---

1. This feature may or may not be enabled for your system.



## Placing Calls

The following instructions describe how to place calls and related features.

### Placing Emergency Calls

#### **WARNING**

Contact your system administrator and your local Mitel provider for important information about dialing emergency services before using your IP phone.

When dialing an emergency number (911 U.S. or 999/112 Australia and Europe), you do **not** have to press the **Outgoing** button or enter the Outgoing Call access code (**8** is the default code). The system automatically places emergency calls immediately after you dial the number, even if you do not select an outside line.

### Placing Emergency Calls using the LIM Line

Emergency Number dialing should only be performed by picking up the handset and selecting the Analog Line key you have programmed. If Privacy Mode is enabled and the Analog Line key local line is busy, dialing will not occur on the LIM line. Emergency dialing using an IP connection may not be supported due to system configuration and country location. For more information, contact your System Administrator. For details about LIM, see “Using the Line Interface Module (LIM)” on [page 11](#).

#### **To make an Emergency Call using the Line Interface Module line:**

1. Lift the handset.
2. Press the **Analog Line** key that you have programmed. ANALOG CALL appears.
3. Dial your local emergency number.

#### **To make an Emergency Call using the Line Interface Module line, when the IP connection has failed:**

1. Lift the handset.
2. Press the **Analog Line** key that you have programmed. IP FAIL: ANALOG CALL appears.
3. Dial your local emergency number.

### Placing Internal Calls

Internal calls are calls placed to other extensions in the system. Internal calls are assigned to the Intercom (IC) button on your IP phone. Contact your system administrator for a list of extension numbers.

#### To place an internal call:

With or without the handset lifted, dial the extension number. If you enter incorrect digits, you can press  (Hold) to move the cursor backward, deleting the last digits entered.

If you are using Handsfree Mode, speak after you hear a double tone.

If there is no answer or if the extension is busy, you can do the following:

- Request a callback (queue). See “[Requesting a Callback \(Queuing the Phone\)](#)” below.
- Camp-on to the busy extension. See “[Using Camp-on](#)” below.
- Leave a message. See “[Leaving Messages at Other Extensions](#)” on [page 69](#).

### Requesting a Callback (Queuing the Phone)

When you request a callback (queue the phone), the system calls you when the extension is available and places a call to the IP phone.

#### To request a callback:

If there is no answer or if the extension is busy, press  (Special) followed by **6** or the **QUEUE** menu button, and then hang up. QUEUE REGISTERED FOR <name> appears. When the extension becomes available, your extension rings.

#### To cancel the callback request:

Press **6** or the **CANCEL QUEUE** menu button. QUEUE REQUEST CANCELED appears.

### Using Camp-on

Camp-on keeps you connected to the called extension until it becomes available. You cannot use Camp-on if the called extension is in DND, or if the call is forwarded to voice mail. See “[Using Do-Not-Disturb \(DND\)](#)” on [page 71](#).

#### To use Camp-on:

Stay on the line and wait for the extension to become available. Do not hang up. If Camp-on is enabled, you hear Music-on-Hold while you are waiting.

## Placing External Calls

The following sections describe features used when placing external calls.

### To place an external call:

1. Press the **Outgoing** button, an unlit **Call Key** button, or enter the Outgoing Call access code (**8** is the default code).
2. Dial the number.

#### NOTES

If you cannot place an external call because all outgoing lines are busy, you can request a callback, which prompts the system to contact you when a line becomes available. See “Requesting a Callback (Queuing the Phone)” on [page 36](#).

If you are prompted for an account code (indicated by a single beep), you must enter an account code before you can place your call. See “Using Account Codes” on [page 42](#).

Depending on system configuration, you may also be able to use one of the following methods to select an outgoing line:

- Enter the Select Line Group feature code. The default codes are 92001 to 92208.
- Enter the Automatic Route Selection (ARS) feature code. The default code is 92000.

Contact your system administrator for more information about using Select Line Group or ARS access codes.

## Redialing a Number

You can quickly redial the last *external* number dialed. You cannot redial extension numbers.

### To use Redial:

With or without the handset lifted, press  (Redial). The system automatically selects a line and dials the number.

## Using Speed Dial

You can use speed dial to quickly dial stored phone numbers. Speed-dial numbers are either stored in the system (System Speed Dial), or in your IP phone (Station Speed Dial).

### Using System Speed Dial

Your system administrator assigns System Speed Dial location numbers, which are available to anyone in the system. Contact your system administrator for more information.

**To view or dial System Speed-Dial numbers:**

1. Dial **381**. REVIEW SYS SPEED # <code range> appears.
2. Do one of the following:
  - Press ▲ (Up) or ▼ (Down) to scroll through the speed-dial locations.
  - Enter the speed-dial location (**000** to **999**).
3. Press # or the **ACCEPT** menu button to dial the number.

### Using Station Speed Dial

You can use Station Speed Dial to store phone numbers for your personal use. Other system users do not have access to your Station Speed-Dial numbers.

#### Storing Station Speed-Dial Numbers

You can store up to 10 Station Speed-Dial numbers.



**To store a Station Speed-Dial number:**

1. With the handset on-hook, dial **383**. PROGRAM STN SPD (0-9) OR SCROLL appears.
2. Do one of the following:
  - Press ▲ (Up) or ▼ (Down) to scroll through the speed-dial bins.
  - Enter the speed-dial bin (**0** to **9**).Press # or the **ACCEPT** menu button to select the bin.
3. Enter the name of the speed-dial contact (up to 10 characters). For dialpad character descriptions, see “Using the Dialpad Buttons to Enter Characters” on [page 24](#).
4. Press # or the **ACCEPT** menu button to save the name.
5. Enter the extension number or external number. If you are storing an external number, enter the Outgoing Call access code (default code is **8**) before you enter the number. Do not use hyphens or colons in stored speed-dial numbers.
6. Press # or the **ACCEPT** menu button to save the bin. STN SPD BIN # <number> UPDATED appears.

## Dialing Station Speed-Dial Numbers

### To dial a Station Speed-Dial number:

Do one of the following:





- Dial **382**, and then enter the Station Speed Dial bin (**0** to **9**). The system dials the number.
- Press  (Up) or  (Down) to scroll through the speed-dial bins, and then press **#** to select the bin and dial the number.

**NOTE**

You can also program buttons to dial Station Speed-Dial numbers. See “Assigning Speed-Dial Numbers to Programmable Buttons” on [page 40](#).

## Deleting Station Speed-Dial Entries

### To delete a Station Speed-Dial entry:

1. With the handset on-hook, dial **383**. PROGRAM STN SPD (0-9) OR SCROLL appears.
2. Do one of the following:
  - Press  (Up) or  (Down) to scroll through the speed-dial bins.
  - Enter the speed-dial bin (**0** to **9**).
3. Press **#** or the **ACCEPT** menu button to select the bin.
4. Press  (Hold) repeatedly until the name is erased, and then press **#** or the **ACCEPT** menu button to continue.
5. Press  (Hold) repeatedly until the number is erased, and then press **#** or the **ACCEPT** menu button. STN SPD BIN # <number> UPDATED appears.

### Assigning Speed-Dial Numbers to Programmable Buttons

You can assign Station or System Speed-Dial numbers to your programmable buttons.

#### NOTE

Before or after assigning the speed-dial number to a programmable button, make sure the speed-dial number has either a Station Speed Dial bin or System Speed Dial location assigned to it. For System Speed Dial numbers, numbers are pre-assigned to the System Speed Dial locations (000 to 999) by your system administrator. Therefore, you just need to choose a System Speed Dial location that you want to use (see "Using System Speed Dial" on [page 38](#) for details). For Station Speed Dial numbers, you must manually store numbers in the Station Speed Dial bins (0 to 9). See "Storing Station Speed-Dial Numbers" on [page 38](#).

#### To program a Station Speed-Dial button:

1. With the handset on-hook, dial **397**. PRESS THE BUTTON TO PROGRAM appears.
2. Press the feature button that you want to program as a speed-dial button.
3. Dial **382**.
4. Do one of the following:
  - Press ▲ (Up) or ▼ (Down) to scroll through the speed-dial bin.
  - Enter the speed-dial bin (**0 to 9**), or select the menu button designation from the display.

#### To program a System Speed-Dial button:



1. With the handset on-hook, dial **397**. PRESS THE BUTTON TO PROGRAM appears.
2. Press the feature button that you want to program as a speed-dial button.
3. Dial **381**.
4. Do one of the following:
  - Press ▲ (Up) or ▼ (Down) to scroll through the speed-dial location.
  - Enter the speed-dial location (**000 to 999**), or select the menu button designation from the display.

## Using the Directory

You can use the Directory to find internal or external contacts or find and activate system features. The directory uses Intelligent Directory Search (IDS), which is similar to the “text on 9 keys” (T9) predictive search feature used for mobile phones. The Directory has the following three subdirectories:

- **Intercom:** Find and dial internal numbers.
- **Outside:** Find and dial external numbers listed in the company directory.
- **Feature:** Find and activate system features.

When searching the directory, dialpad buttons can represent several characters, as shown in the following table. As you enter characters, the entries that best match the characters entered appear. The system connects the character sequence to possible directory matches. For example, to find the name “Jones,” dial **56637**.

Button	Characters Represented
0	0
1	1
2	2 A B C a b c Ç â ä à å ç Ä Å á
3	3 D E F d e f é ê ë è É
4	4 G H I g h i i i í
5	5 J K L j k l
6	6 M N O m n o ô õ ò Ö ó ñ Ñ
7	7 Q P R S q p r s
8	8 T U V t u v ü û ù Ü ú
9	9 W X Y Z w x y z ÿ
 (Up)	Scroll to next entry
 (Down)	Scroll to previous entry
*	Cancel search
#	Activate selection
 (Hold)	Move the cursor to the left, deleting existing characters

See [page 42](#) for detailed instructions on using the directory.

### To search for a directory name or feature:

1. Dial **307**, and then press one of the following:
  - **1** for the IC directory.
  - **2** for the Outside directory.
  - **3** for the Feature directory.
  - The Directory menu button (**IC**, **OUTSIDE**, or **FEATURE**).
2. Press the dialpad buttons to enter (up to 20) characters. See the table on [page 41](#) for dialpad button character descriptions.
3. Press **▲** (Up) or **▼** (Down) or the **>>** (Next) or **<<** (Previous) menu buttons to scroll through the entries.

#### NOTE

The IC directory may display two similar entries, one without an asterisk and one with an asterisk. The entry without an asterisk is the primary extension. The entry with an asterisk is a secondary extension.

4. Press **#** (or the menu button next to the entry) while the display shows the entry to dial a number or activate a feature code.

## Using Account Codes

Account codes record information for phone record reports. You may be required to enter account codes when placing calls. Contact your system administrator for more information about using account codes.

There are three types of account codes:

- **Standard account codes:** Automatically entered into the phone record report whenever you place a call.
- **Forced account codes:** Entered before you can place an outside call.
- **Optional account codes:** Entered at any time during a call.

### To enter an optional account code:

1. While off-hook, press **⊗** (Special), and then dial **390**.
2. Enter the optional account code, and then press **#**.

### To set an account code for all calls placed from your IP phone:

Dial **391** followed by the account code, and then press **#**. **ACCOUNT CODE ACCEPTED** appears. This code is used for all calls made from your IP phone until it is disabled.

### To disable the code:

Dial **391**, and then press **#**. **ACCOUNT CODE CLEARED** appears.



---

# Call Features

The following sections describe call-related features.

## Using Handsfree Mode

You can use Handsfree Mode to activate the speakerphone.

### NOTES

The Ring Intercom Always feature prevents calls from being answered in Handsfree Mode (see the following section).

You cannot use Handsfree Mode if you are using a headset, or if you have more than one phone assigned to an extension number.

#### To use Handsfree Mode:

With the handset on-hook, dial **319**. HANDSFREE MODE ON appears. Dial **319** again to turn Handsfree Mode off.

## Using Ring Intercom Always

If another extension has Handsfree Mode enabled for incoming internal calls (see the previous section), you can use Ring Intercom Always to override Handsfree Mode on the extension, requiring the called party to pick up the handset to answer your call.

#### To override Handsfree Mode for the current call:

1. Before you enter the extension number, press **#**. RING EXTENSION NUMBER appears.
2. Dial the extension number.



#### To use Ring Intercom Always to always send non-handsfree calls:

With the handset on-hook, dial **377**. RING IC ALWAYS ON appears. Dial **377** again to turn Ring Intercom Always off.

## Using Mute

You can use Mute to temporarily turn off your microphone, preventing the other party on the call from hearing you.

#### To mute or unmute the microphone:

While on a call, press  (Mute). MICROPHONE MUTE ON appears. When the microphone is muted, the Mute button lamp is lit. Press  (Mute) again to unmute the microphone.

## Placing Calls On Hold

You can place calls on either Individual Hold or System Hold.

- **Individual Hold:** Places an internal or external call on hold at your IP phone.
- **System Hold:** Places an external call on hold in the system. You can then pick up the call from any phone that indicates a flashing Call button for the call, including the IP phone that placed it on hold.

### To place a call on Individual Hold:

1. Press  (Hold). ENTER EXTENSION NUMBER appears.
2. Hang up or place another call.



### To place an outside call on System Hold:

1. Press  (Special), and then dial **335**. ENTER EXTENSION NUMBER appears.
2. Hang up or place another call.

### To place a call on hold and answer a waiting call:

Press  (Hold), and then press the flashing **IC** or **Call Key** button.

### To return to a call that is on hold:

Press  (Hold), and then lift the handset or press  (Speaker). <Caller> WAS HOLDING appears.

## Entering a Hookflash

Some telephone companies require you to enter a hookflash (a quick hang up and release) for feature access.

### To enter a hookflash:

While off-hook, press  (Special), and then dial **330** or press the **FLASH** menu button.

## Transferring Calls

You can transfer calls to other extensions or external numbers. You can also transfer conference calls. See “Transferring a Conference” on [page 52](#) for more information.

### Transferring Calls to Other Extensions

#### To transfer a call to another extension:

1. While on the call, press  (Transfer), and then enter the extension number.
2. Do one of the following:
  - Wait for an answer, announce the call, and then hang up. If the extension is unavailable, press the flashing **IC** or **Call Key** button to return to the caller.
  - Hang up to transfer the call and disconnect the call from your IP phone.

#### NOTE

If your system administrator has enabled the Transfer-on-Connect Allowed feature for your IP phone, you are automatically connected to calls transferred to your extension after the transferring party hangs up. If this option is turned off, you must press an **IC** or **Call Key** button to answer calls transferred to your extension.

### Transferring Calls to External Numbers

#### To transfer a call to an external number:

1. While on the call, press  (Transfer).
2. Press the **Outgoing** button or the Outgoing Call access code (the default code is **8**) to select an outside line.
3. Dial the phone number.
4. Do one of the following:
  - Wait for an answer, announce the call, and then hang up. If the extension is unavailable, press the flashing **Call Key** button to return to the caller.
  - Hang up to transfer the call and disconnect the call from your IP phone.

### Using Reverse Transfer

You can use Reverse Transfer (Call Pick Up) to answer calls that are ringing or holding at other extensions. For example, if you receive a call while you are away from your desk, you can pick up the call from another extension.

#### To use Reverse Transfer:

1. Lift the handset, and then press **4**. ENTER EXTENSION NUMBER appears.
2. Dial the extension or hunt group number or press a PKM button where the call is ringing or holding. The call is transferred to the IP phone you are using and you are connected to the caller.

### Parking a call and Picking up a Parked call

#### To park a call

While on the call, press the button designated as a Park/Pickup destination and then hang up.

The button will flash to indicate at least one call is parked at that destination.

### To pickup a parked call

While not on a call, press the flashing button designated as a Park/Pickup destination.

#### NOTE

Before you can use the Park feature, your system administrator will need to provision at least one Park/Pickup destination button. Alternatively, you can use the User Web Portal (if enabled) to provision the required buttons on your phone.

## Using Group Call Pick-up

You can use Group Call Pick-up to answer calls that are ringing on other phones within a group.

### To use Group Call Pick-up

Press the flashing button designated as a Park/Pickup button for the required Pick-up Group.

#### NOTE

Before you can use the Group Pick-up feature, your system administrator will need to create Pick-up Groups, assign the members and provision park/Pick button(s) on your phone. If pick-up groups have already been configured, you can use the User Web Portal (if enabled) to provision the required buttons on your phone.

---

## Viewing Your System Information

If you are on a call, you can temporarily view your user information (your user name and your extension number).

**To display your user information:**

Press **X** (Special), and then dial **300**.

## Viewing Caller ID Information

If you are currently connected to an external caller with Caller ID, you can toggle between the caller's name and number. If the name is unavailable, CANNOT ACCESS FEATURE appears.

**To show the outside party's name/number:**

Press **X** (Special), and then dial **379**.

## Forwarding Calls

You can use Manual Call Forwarding or System Forwarding to forward calls.

### Manual Call Forwarding

The following table describes Manual Call Forwarding options.

Call Forward Feature	Description	Code/Menu Button
Call Forward All Calls	All incoming calls are forwarded.	355 ALL
Call Forward If No Answer	All incoming calls are forwarded if not answered. (The timer is set by the system administrator.)	356 NO ANSWER
Call Forward If Busy	When your IP phone is busy, all incoming calls are forwarded without ringing.	357 BUSY
Call Forward If No Answer/Busy	All incoming calls are forwarded if your IP phone is busy, or if you do not answer.	358 NO ANSWER/BUSY

#### To use Manual Call Forwarding:

1. Press the **Forward** button followed by the menu button designation, or dial the Manual Call Forwarding feature code from the previous table. ENTER FORWARD DEST appears.
2. Enter the extension number, or press the **Outgoing** button or the **Outside** menu button, and then dial the telephone number. On the 5360 IP Phone, you can press the **VOICE MAIL** menu button to forward calls to the Message Center (voice mailbox). FWD ALL CALLS TO <number> appears.

#### To cancel a Call Forwarding request, do one of the following:

- Press **Forward** button, and then press the **FWD OFF** menu button.
- Enter a Forward feature code, and then press #.

#### NOTE

If the Configuration Assistant feature is enabled for your system, you can access a voice guided configuration portal that provides easy-to-use, remote access to the Call Forwarding feature. See [page 60](#) for details.

### System Forwarding

You can use System Forwarding to route calls based on the type of call and the idle or busy status of your IP phone. You cannot program the System Forward destination. You can only turn it on or off. Contact your system administrator for more information.

#### To turn System Forwarding on or off:

Dial **354**. SYSTEM FORWARD ON appears. Dial **354** again to turn System Forwarding off.

## Using Dynamic Extension Express

When you enable Dynamic Extension Express (DEE) on your IP phone, your incoming calls are automatically routed to one or more preprogrammed associated destinations according to the routing steps programmed for you.

Typically, your desk phone is configured to be your main extension. You may be programmed for up to ten associated destinations including: softphone, home IP phone, voice mail, mobile phone, home phone, desk phone 2, mobile phone 2, softphone 2, home IP phone 2, and home phone 2.

Your desk phone, softphone, home IP phone and voice mail extensions are already programmed in the system, so your system administrator can easily include them in your routing steps. To include your mobile and home phone numbers in your routing steps, you will need to provide these numbers to your system administrator.

### To enable Dynamic Extension Express:

Dial **363** (on) or **364** (toggle on/off). PERSONAL ROUTING ON appears on the display.

### To disable Dynamic Extension Express:

Dial **362** (off) or **364**. PERSONAL ROUTING OFF appears on the display.

### To answer a call routed to your mobile or home phone:

1. Answer the call when it rings your IP phone. After you speak, the Dynamic Extension Express prompt is played.
2. Do one of the following:
  - Press # to accept the call.

#### NOTE

You do not need to wait for the prompt to accept the call. You can accept the call immediately by pressing the # button.

- Press \* to send the call to the voice mailbox associated with your main extension (not your mobile phone or home phone voice mailbox). If you do not have a voice mailbox, the "Press \*..." prompt is not played and the call is routed to your main extension.

If you hang up, the call continues to follow your programmed routing steps.

When you enable Dynamic Extension Express, your incoming calls are routed as specified by the routing type programmed for you by your system administrator. The table below provides descriptions for the default routing types.

Routing Type	Description
Mobile Twinning	Calls simultaneously ring your desk phone and mobile phone, before going to voice mail.
Delayed Mobile Twinning	Calls ring your desk phone first, and then ring both your desk phone and mobile phone, before going to voice mail.

Check with your system administrator to see which routing type has been programmed for you. Your administrator can modify these routing types by adding or removing routing steps, adding or removing destinations, and changing the ring timers, if required.

To ensure that calls are routed correctly to your mobile and home phones, inform your system administrator if either of these phone numbers change.

The following call types do not follow Dynamic Extension Express:

- Hunt group calls
- Hunt group announcement/overflow calls
- Transfer recalls, Hold recalls, Conference recalls, and Attendant recalls

### NOTE

A recall occurs when a feature cannot be completed or the feature times out, and the call returns to the originating extension. For example, a holding call will recall the extension where it was placed on hold when the hold timer expires.

## Using the Handoff - Push/Pull Feature

Dynamic Extension Express also includes the Handoff feature, which includes the following functions:

- **Push:** The Handoff “push” function allows you to move an active call from any of your internal associated destinations (unless that destination is a 5610 Cordless Handset or a UC Express SIP Softphone) to an associated destination without disconnecting audio. The push function is useful if you are leaving the work area, but want to remain connected to an active call.
- **Pull:** The Handoff “pull” function allows you to pull a call that was previously routed to your mobile or home phone back to any of your internal associated destinations (unless that destination is a 5610 Cordless Handset or a UC Express SIP Softphone). The pull function is useful if you answer a call on your mobile phone and then return to your desk.

### To use the Dynamic Extension Express – Handoff “push” feature:

1. While on an active call at your IP phone, press **ⓧ** (Special), and then dial **388**. HANDOFF IN PROGRESS appears on the display and the call rings all of your associated destinations (except voice mail).
2. Press **#** to accept and answer the call at your mobile or home phone. You are immediately connected to the other parties at the new destination. When the call is switching over to the new destination, there may be a momentary break in audio, which may be noticeable to the other parties on the call.

### To use the Dynamic Extension Express – Handoff “pull” feature:

While on an active call on an associated destination device, dial **388**. A confirmation tone is played and the call is pulled back to your IP phone. The call is connected immediately and you can then access system features such as conference, hold, and transfer.

### NOTES

If you enter the handoff feature code (388) and the display shows NO CALL TO HANDOFF, the call cannot be handed off (see [page 99](#)).

If your phone has a button programmed for the Handoff feature, then the button will light if there is a call available to pull.

### To cancel the Dynamic Extension Express – Handoff feature:

While the handoff is in-progress, press **ⓧ** (Special), and then dial **388**. HANDOFF CANCELLED appears on the display for your main extension.



---

## Receiving Message Waiting Indications

If your main extension receives a message waiting indication (MWI) from voice mail or the system's station messaging feature, the MWI is propagated (as applicable) to your other internal associated destinations. If any of your internal associated destinations responds to the MWI, then the MWI is cleared on all of them. Note that if any destination other than your main extension receives an MWI, it will not propagate to the other internal destinations. The MWI has to originate on your main extension.

If enabled, the system can send a text message to your mobile phone to indicate that your main system extension has received a new station message or voice mail message.

Here is an example of an e-mail message generated by a station message:

**You have a message from <Username> at extension <Extension>.**

**Callback: <Auto Attendant Number>**

Here is an example of an e-mail message generated by a voice mail message:

**You have a new voice mail message for mailbox number <Mailbox Number>.**

**Callback: <Voice Mail Notification and Retrieval Number>**

You can use the callback number to easily call back into the system and speak to the messaging party or retrieve your voice mail message. Check with your administrator if you would like to take advantage of this feature.

## Placing Ad Hoc Conference Calls

You can place a Ad Hoc<sup>1</sup> conference call with up to three internal or external parties (for a total of four parties, including yourself).

### To place a conference call:

1. While on the first call, press the **Conference** button to place the call on hold. CALL NEXT PARTY TO CNF appears.
2. Place a call to the next conference party (for external calls, press the **Outgoing** button or the Outgoing Call access code [**8** is the default code], and then dial the number).
3. After the party answers, announce the conference, and then press the **Conference** button to place the call on hold. If necessary, repeat this step to add the remaining conference party.
4. Press the **Conference** button again or the **CONNECT TO CNF** menu button to start the conference. CNF IN PROGRESS appears.

## Adding a Conference Party

You can add a conference party during the conference.

### To add a conference party:

1. Press the **Conference** button or the **ADD PARTY** menu button. This leaves the conference parties connected.
2. Place a call to the party to be added to the conference, and then announce the conference. Press the **Conference** button (twice) or the **CONNECT TO CNF** menu button to add the party and rejoin the conference.

## Transferring a Conference

You can transfer an existing conference to another extension.

### To transfer a conference:

1. During the conference, press  (Transfer), and then dial the extension number.
2. Announce the conference (if desired), and then hang up. CONFERENCE TFR from <name> appears on the called party's display. The party must then press the flashing **Conference** button to connect to the conference.

## Dropping Out of a Conference

You can drop out of a conference and return to the conference later.

### To drop out of a conference:

Press the **Conference** button or  (Hold), and then hang up. ENTER EXTENSION NUMBER appears. This removes you from the conference but leaves the other parties connected.

### To return to the conference:

Press the flashing **Call Key** button. CONFERENCE WAS HOLDING appears, and you are reconnected to the conference.

---

1. The traditional conferencing feature that has always been available on the MiVoice Office 250 has been renamed as Ad Hoc Conferencing to differentiate it from the Meet-Me Conferencing feature introduced in v5.0 (see [page 54](#)).

---

## Ending a Conference and Placing all Parties on Hold

You can end a conference and place all conference parties on Individual Hold, allowing you to toggle between the held parties and speak to one party at a time.

### To end a conference and place all parties on Individual Hold:

Press the **Conference** button, and then press  (Hold). CONFERENCE PARTIES ON HOLD appears.

### To toggle between the held callers:

Press  (Hold) twice for internal parties or the applicable **Call Key** button for external parties.

## Using Meet-Me Conferencing

The Meet-Me Conferencing feature allows up to eight internal and/or external callers to dial into a conference instead of being manually added by an internal user, as is the case when using the system's traditional "ad hoc" conferencing method. (See [page 52](#) for details on using the traditional Ad Hoc Conferencing method.)

Note that unlike an Ad Hoc Conference, a Meet-Me Conference can consist entirely of outside parties; an internal system user does not have to be present. Also note that the traditional Ad Hoc Conferencing feature is still available for use even when Meet-Conferencing is licensed and enabled. Both conferencing types are available for use as needed.

Many existing system features that work with the traditional Ad Hoc Conferencing method (such as Record-A-Call, transferring a conference, placing a conference on hold, etc.) also work with the Meet-Me Conferencing method.

## Conference Assistant

Conference Assistant is a voice-guided application that allows you to initiate or join a Meet-Me Conference by dialing the extension number assigned to the Conference Assistant and then entering the proper access code. If you enter an invalid access code, the Conference Assistant prompts you to try again. The Conference Assistant also lets you know if there are no conferencing circuits available or if the conference is already at capacity.

## Access Codes

If Meet-Me Conferencing is enabled for your system, you have the ability to initiate or join a Meet-Me Conference by dialing the Conference Assistant and entering a valid access code. Access codes are typically generated to match each user's extension number, so that each user has their own personal access code for establishing Meet-Me Conferences.

In addition to the personal access code that may match your extension, you can also use the Configuration Assistant application to create conferences with unique system-generated access codes. (See [page 60](#) for details.)

## Setting Up a Meet-Me Conference

You can set up a Meet-Me Conference using either your personal access code or a system-generated access code. (See the previous section for more information on access codes.)

### **To set up a Meet-Me Conference using a personal access code:**

1. Tell all intended conference participants to call the Conference Assistant at an agreed-upon time and use your extension number as the access code to join the conference.
2. Follow the instructions for "Joining a Meet-Me Conference" on [page 55](#).

### **To set up a Meet-Me Conference using a system-generated access code:**

1. Generate a Meet-Me Conference access code through the Configuration Assistant application (see [page 63](#)).
2. Tell all intended conference participants to call the Conference Assistant at an agreed-upon time and use the system-generated number as the access code to join the conference.
3. Follow the instructions for "Joining a Meet-Me Conference" on [page 55](#).

---

## Joining a Meet-Me Conference

You can join a conference with up to seven internal and/or external parties (for a total of eight parties, including yourself).

### To join a Meet-Me Conference:

1. Dial (or ask to be transferred to) the Conference Assistant extension number. (See your administrator if you do not know the extension number.) You hear: "Welcome to the Conference Assistant. Enter an access code, and then press Pound (#). To cancel, press Star (\*)."
2. Enter the appropriate access code for the Meet-Me Conference you wish to join (see "Access Codes" on [page 54](#)). Note the following:
  - If you enter an invalid access code, the Conference Assistant prompts you to try again.
  - If there are no conferencing resources available, or if the maximum number of allowed parties has already been reached, you hear: "All circuits are busy. Please try again later." Hang up and try again later.
3. Once connected, you can talk with other parties who join the conference. (Your phone shows the name of the conference [if available], the total conference duration, and the number of parties connected to the conference.) Note the following:
  - If you are the first person in the conference, you hear: "You are the first person in this conference. Please stay on the line." You then hear music until another caller joins the conference or you hang up.
  - As other parties join or leave the conference, you hear a tone to signal the change.
  - If the conference contains only external callers, the Conference Assistant will prompt the participants to extend the conference after a period time. If no one presses a digit to extend the conference, the system terminates the conference.

## Dropping Out of a Meet-Me Conference

You can leave a conference and still leave the other parties connected.

### To exit a Meet-Me Conference:

Hang up. The other parties in the conference remain connected.

## Putting a Meet-Me Conference on Hold

You can put a conference on hold at your phone (the other parties remain connected) and then later return to the conference.

### To put a Meet-Me Conference on Hold:

During the conference, press the **Hold** button.

### To return to the Meet-Me Conference:

Lift the handset or press the **Speaker** button, and then press the **Hold** button.

## Transferring a Meet-Me Conference

You can remove yourself from a conference and transfer it to another party.

### To transfer a Meet-Me Conference to another extension:

1. During the conference, press the **Transfer** button, and then dial the extension number.
2. Announce the conference (if desired), and then hang up. CONFERENCE TFR from <name> appears on the called party's display.

## Using Record-A-Call

You can use Record-A-Call to record an ongoing call as a mailbox message.<sup>2</sup> You can then retrieve the message from your voice mailbox. The Record-A-Call feature stays active after the other party hangs up, so you can add to the recorded call with your own message.

**NOTE** Record-A-Call is not supported on peer-to-peer (P2P) calls. Contact your system administrator for more information.

### To use Record-A-Call:

1. While on a call, press **(X)** (Special), and then dial **385**, or press the **RECORD-A-CALL** menu button. **REQUESTING RECORD-A-CALL** appears.
2. Enter the voice mailbox number where you want the recording to be saved. **RECORD-A-CALL IN PROGRESS** appears, and both you and the calling party hear a confirmation tone (if enabled).

**NOTE** If your system administrator assigns the Record-a-Call voice mailbox destination, you do not need to enter the voice mailbox number.

### To stop Record-A-Call:

Do one of the following:

- Press **(X)** (Special), and then dial **385**.
- Press the **CANCEL RECORDING** menu button.
- Hang up.

## Using Group Listen

You can use Group Listen to activate the speaker while you use the handset or headset to continue speaking. This allows other people to hear the other party on the call while the other party can only hear you (through the handset microphone). You cannot use Group Listen in Handsfree Mode.

### To use Group Listen:

While on a call, press **(X)** (Special), and then dial **312**. **GROUP LISTEN ON** appears, and you hear a confirmation tone. The other party does not hear the confirmation tone. Dial **312** again to turn Group Listen off.

---

<sup>2</sup> This feature may or may not be enabled for your system.

---

## Using Call Logging

Your call logs are records of your most recent missed, received, and dialed calls. A maximum of 20 entries are stored in each call log.<sup>3</sup>

You can use Call Logging to:

- View recent call activity.
- View caller ID information.
- Return or redial calls.

### To use Call Logging:

1. Dial **333** or the **LOGS** menu button.
2. Select one of the following options:
  - Press **1** (MISS) or the **MISSED CALLS** menu button for missed calls.
  - Press **2** (RCV) or the **RECEIVED CALLS** menu button for received calls.
  - Press **3** (DL) or the **DIALED CALLS** menu button for dialed calls.
  - Press **4** (CLR) or the **CLEAR LOGS** menu button to clear all entries.
3. Press **▲** (Up) or **▼** (Down) or the **>>** (Next) or **<<** (Previous) menu buttons to scroll through the entries.

The display shows the party's name and the extension or outside number (if available) and the date and time.

If no Caller ID information is available, UNKNOWN CALLER appears.

### To return a call or redial a number listed in a call log:

Press **#** or the **CALL NOW** menu button while the display shows the number.

### To delete individual call log entries:

Press **0** or the **DELETE** menu button to delete the displayed entry, or press the **DEL ALL** menu button to delete all entries in the current call log.

---

3. This feature may or may not be enabled for your system.

## Using Secondary Extension Buttons

Secondary Extension buttons must be programmed by your system administrator. You can use programmable buttons as “secondary extensions.” Secondary Extensions are assigned to other extensions in the system (primary extensions). Because Secondary Extension buttons are programmed by the system administrator, you cannot change the buttons (for example, assign features to the buttons).

When programmed, you can use Secondary Extension buttons to:

- Place an internal call to the primary extension.
- View the call activity at the primary extension.
- Transfer calls to the primary extension.
- Answer a call that is ringing or holding on any **Call Key** button at the primary extension.

### NOTES

The system administrator must set up the **Call Key** buttons for internal calls or you cannot use Secondary Extensions at the primary extension.

You can use Secondary Extension buttons to notify you when a given number of calls are waiting at the primary extension.

If a Secondary Extension button is flashing (the primary extension has an incoming call), you can press # before pressing the flashing Secondary Extension button to call the primary extension and not answer the incoming call.



---

## Using Hot Desking

The Hot Desking feature allows users to share phones or temporarily move to other phones and yet maintain their personal identity and preferred phone configuration settings.

If your administrator has set you up with a Hot Desking Profile, you can log on to any Hot Desk-enabled base phone using the Hot Desk feature code (default is 348), your assigned Hot Desk Profile extension number, and your assigned Hot Desk Profile passcode. The system will then apply your phone profile – phone settings such as extension (intercom directory) number, class-of-service, language, programmable buttons, etc. – to the phone.

### To log on to a Hot Desk-enabled base phone:

1. At a Hot Desk-enabled base phone, do one of the following:
  - Press the Hot Desk feature button (if one is programmed on the phone).
  - Press the LOGIN menu button (on six-line display phones).
  - Dial **348**.

Display phones show ENTER HOT DESK EXTENSION.

2. Dial your assigned Hot Desk extension number. Display phones show ENTER PASSCODE.
3. Dial your assigned Hot Desk passcode. Display phones show HOT DESK SESSION ACTIVATED for five seconds.

### To log off of a Hot Desk session:

Do one of the following:

- Press the Hot Desk feature button (if one is programmed on the phone).
- Press the LOGOUT menu button (on six-line display phones).
- Dial **348**.

Display phones show HOT DESK SESSION TERMINATED for five seconds.

If you forget to log off and then attempt to log on elsewhere, the system automatically logs you off of the original phone so that you can log on to the new phone.

## Using the Configuration Assistant

If Configuration Assistant is enabled for your system, you can access this voice guided configuration portal that provides easy-to-use, remote access to the following phone configuration options:

- Dynamic Extension Express (see [page 64](#))
- DND (see [page 62](#))
- Manual Call Forwarding (see [page 62](#))
- Meet-Me Conferencing (see [page 63](#))

**NOTE**

You need a Configuration Assistant extension number to use this feature. Contact your system administrator for more information.

## Changing Your Station Passcode

Before using the Configuration Assistant, Mitel recommends that you change your default station (phone) passcode to something more secure.

**To change your station passcode:**

1. Dial **392**. ENTER PASSCODE appears.
2. Enter your current passcode (the default passcode is your extension number), followed by **#**. CHANGE PASSCODE TO appears.
3. Enter the new passcode followed by **#**. VERIFY PASSCODE appears.
4. Enter the new passcode again followed by **#**. DATABASE UPDATED appears.

To change the passcode from another phone, see “Changing Your Station Passcode” on [page 67](#).

## Accessing the Configuration Assistant

Follow the instructions below to access the Configuration Assistant.

### To access the Configuration Assistant:

1. Access the Configuration Assistant extension number from inside or outside the system by:
  - dialing it from any phone in the system.
  - being transferred to it.
  - dialing it from automated attendant, voice mail, or DISA.
2. Do one of the following:
  - If calling from your main desktop phone, proceed to step 3.
  - If calling from someone else's main desktop phone that is designated as a Configuration Assistant user, press the Star button (\*), and then enter your extension number.
  - If calling from a phone that is not designated as a Configuration Assistant user, enter your extension number.
  - If transferred to the Configuration Assistant or if calling the Configuration Assistant from outside the system, enter your extension number.
3. Enter your station passcode, and then press #. You may now change the settings for any of the following features:
  - Dynamic Extension Express (see below)
  - DND (see [page 62](#))
  - Manual Call Forwarding (see [page 62](#))
  - Meet-Me Conferencing (see [page 63](#))

## Changing the Dynamic Extension Express Settings

**NOTE**

This feature is available only if the authenticated extension is identified as a Dynamic Extension Express (DEE) user. See "Using Dynamic Extension Express" on [page 49](#) for more information.

### To change the DDE settings using Configuration Assistant:

1. Access the Configuration Assistant as described in "Accessing the Configuration Assistant" on [page 61](#).
2. Follow the voice prompts to change your DEE status (on or off) or program a mobile phone number. When this option is selected, Configuration Assistant first states whether DEE is currently enabled or not (for example, "Dynamic extension is enabled"), and then offers the following DEE functions:
  - Enable (only if DEE is disabled)
  - Disable (only if DEE is enabled)
  - Program mobile phone number [you do not have to enter the Outgoing feature code (8)]
3. Hang up, or press the Star button (\*) to return to the main menu.

## Changing the DND Settings

See “Using Do-Not-Disturb (DND)” on [page 71](#) for more information about using DND.

### To change the DND settings using Configuration Assistant:

1. Access the Configuration Assistant as described in “Accessing the Configuration Assistant” on [page 61](#).
2. Follow the voice prompts to change your DND status (on or off). There is no option to provide a specific DND status message. When this option is selected, Configuration Assistant first states whether DND is currently enabled or not (for example, “Do-Not-Disturb is currently disabled”), and then offers the following DND functions:
  - Enable (only if DND is disabled)
  - Disable (only if DND is enabled)
3. Hang up, or press the Star button (\*) to return to the main menu.

## Changing the Manual Call Forwarding Settings

See “Manual Call Forwarding” on [page 48](#) for more information about Manual Call Forwarding.

### To change the Manual Call Forwarding settings using Configuration Assistant:

1. Access the Configuration Assistant as described in “Accessing the Configuration Assistant” on [page 61](#).
2. Follow the voice prompts to change your manual call forwarding status (on or off). There is no option to provide a specific call forwarding condition, such as no answer or busy. When this option is selected, Configuration Assistant first states whether call forwarding is currently enabled or not (for example, “Call Forwarding is enabled”) and then offers the following forwarding functions:
  - Forward calls to voice mail
  - Forward calls to an internal extension number
  - Forward calls to an external phone number [you do not have to enter the Outgoing feature code (8)]
  - Disable (only if Call Forwarding is enabled)
3. Hang up, or press the Star button (\*) to return to the main menu.

---

## Managing Meet-Me Conferencing Access Codes

See “Using Meet-Me Conferencing” on [page 54](#) for more information about Meet-Me Conferencing.

**NOTES**

This feature is available only if Meet-Me Conferencing is enabled on your phone system.

While using Configuration Assistant options, you can press the Star button (\*) any time you wish to cancel the current operation and return to the main menu.

**To create a new Meet-Me Conference access code:**

1. Access Configuration Assistant as described in your existing phone user guide.
2. Follow the voice prompts to select the conference option, and then select the option to create a new conference access code. Configuration Assistant states your new access code.
3. Hang up, or press \* to return to the main menu.

**To delete an existing Meet-Me Conference access code:**

1. Access Configuration Assistant as described in your existing phone user guide.
2. Follow the voice prompts to select the conference option, and then select the option to delete an existing conference access code. Configuration Assistant prompts you for the access code you wish to delete.
3. Enter the access code, and then press #. If you enter an access code that does not exist, Configuration Assistant prompts you to enter another access code.
4. Hang up, or press \* to return to the main menu.

**To list all of your existing Meet-Me Conference access codes:**

1. Access Configuration Assistant as described in your existing phone user guide.
2. Follow the voice prompts to select the conference option, and then select the option to list your conference access codes. Configuration Assistant first states the number of access code you have and then states all of your existing access codes.
3. Hang up, or press \* to return to the main menu.

**To send yourself an e-mail message listing all of your existing conference access codes:**

1. Access Configuration Assistant as described in your existing phone user guide.
2. Follow the voice prompts to select the conference option, and then select the option to e-mail yourself a list of your existing access codes. You should soon receive an e-mail message that lists all of your existing access codes, including the code number, code name, and when the code was last used.
3. Hang up, or press \* to return to the main menu.

**NOTE**

If you do not have an e-mail address configured in the phone system database, then this option is not provided. Check with your administrator if you would like to take advantage of this feature.

## Using E-Mail Synchronization

If you have a Unified Voice Messaging (UVM) mailbox (previously called a Basic Voice Mail mailbox) and your system is enabled for E-Mail Synchronization, your administrator may give you the option to access, play, and manage your voice mail messages directly from your computer or Blackberry® mobile device e-mail client application. If so, each UVM voice mail message that you receive can also be delivered as an audio file attachment within an e-mail message sent to your account.

In addition to the basic Forward and Forward and Copy levels available prior to v5.0, UVM now provides two additional levels, as described below:

- **Forward Only:** This level delivers a voice message to your e-mail address each time you receive a new voice message in your voice mailbox. After the message is sent, the original message is deleted from your voice mailbox. This level does not provide integration between your e-mail client and voice mailbox.
- **Forward and Copy:** This level delivers a copy of a voice message to your e-mail address each time you receive a new voice message in your voice mailbox. The original message can still be retrieved from your voice mailbox.
- **Enhanced Integration:** This level delivers new voice messages to both your e-mail address and your voice mailbox, and synchronizes those messages. For example, if you delete a voice message from your e-mail client, the message is also deleted in your voice mailbox. In addition, you receive a Welcome e-mail message and error notification e-mail messages if an error occurs. This level does provide integration between your e-mail client and voice mailbox. not provide integration between your e-mail client and voice mailbox.
- **BlackBerry Enhanced Integration:** This level, which is similar to the Enhanced Integration level, delivers new voice messages to both your BlackBerry e-mail address and your voice mailbox. This level does provide integration between your e-mail client and voice mailbox.

For details on using the E-Mail Synchronization feature, refer to the *UVM E-Mail Synchronization User Guide*.

## Using Remote Programming

If the Configuration Assistant feature is enabled for your system, Mitel recommends that you use Configuration Assistant instead of the Remote Programming feature described in this section. Configuration Assistant offers an enhanced, voice guided configuration portal that provides easy-to-use, remote access to the Call Forwarding, Dynamic Extension Express, and DND features. See [page 60](#) for using Configuration Assistant.

To use Remote Programming to access these features from another system phone or an external phone, follow the instructions in this section.<sup>4</sup>

**NOTE**

A Direct Inward System Access (DISA) number is required to use Remote Programming from an external phone. Contact your system administrator for more information.

## Changing the Dynamic Extension Express Settings

See “Using Dynamic Extension Express” on [page 49](#) for more information about Dynamic Extension Express.

**To enable Dynamic Extension Express using Remote Programming:**

1. Do one of the following:
  - Call your DISA number (provided by the system administrator). If necessary, enter \_\_\_\_\_
4. This feature may or may not be enabled for your system.

your DISA security code.

- Use any phone on the system.
2. Dial **359**.
  3. Enter your extension number.
  4. Enter your station passcode followed by **#**. See [page 60](#) for details on setting up a passcode for your extension.
  5. Dial **363** (Dynamic Extension Express On).

**To disable Dynamic Extension Express using Remote Programming:**

Follow steps 1. - 4. above, dial **362** (Dynamic Extension Express Off), and then hang up.

## Changing the DND Settings

See “Using Do-Not-Disturb (DND)” on [page 71](#) for more information about using DND.

### To turn on DND using Remote Programming:

1. Do one of the following:
  - Call your DISA number (provided by your system administrator). If necessary, enter your DISA security code.
  - Use any phone on the system.
2. Dial **359**.
3. Enter your extension number.
4. Enter your station passcode followed by **#**. See [page 60](#) for details on setting up a passcode for your extension.
5. Dial **370**.
6. Enter the DND message number (01 to 20), and then enter the second-line message text (if applicable).

### To turn off DND using Remote Programming:

Follow steps 1. through 4. above, and then dial **371**.

## Changing the Manual Call Forwarding Settings

See “Manual Call Forwarding” on [page 48](#) for more information about Manual Call Forwarding.

### To turn on Manual Call Forwarding using Remote Programming:

1. Do one of the following:
  - Call your DISA number (provided by your system administrator). If necessary, enter your DISA security code.
  - Use any phone on the system.
2. Dial **359**.
3. Enter your extension number.
4. Enter your station passcode followed by **#**. See [page 60](#) for details on setting up a passcode for your extension.
5. Dial one of the following Call Forwarding feature codes:
  - **355** (All)
  - **356** (No answer)
  - **357** (Busy)
  - **358** (No Answer/Busy)
6. Enter either an extension number or **8** followed by a phone number.

### To turn off Call Forwarding using Remote Programming:

Dial **355**, and then hang up.



---

## Changing Your Station Passcode

You can use Remote Programming to change the station (phone) passcode. See [page 60](#) for details on setting up a passcode for your extension.

### To change your station passcode using Remote Programming:

1. Do one of the following:
  - Call your DISA number (provided by your system administrator). If necessary, enter your DISA security code.
  - Use any phone on the system.
2. Dial **359**.
3. Enter your extension number.
4. Enter your passcode followed by **#**.
5. Dial **392**.
6. Enter the new passcode followed by **#**.
7. Enter the new passcode again followed by **#**.



# Messages

This section describes the following system messaging features:

- **Inter-station messages:** Inter-station messages are alerts sent to your IP phone by other internal parties, notifying you to contact the party who left the message. The  (Message) button and Message/Ring Indicator flash to notify you of the new message. You can then either delete the message or reply to the message, which automatically places a call to the party who left the message.
- **Do-Not-Disturb (DND) messages:** Messages that other internal parties see when your IP phone is in DND. See “Using Do-Not-Disturb (DND)” on [page 71](#).
- **Reminder messages:** Messages that you can use to notify yourself of upcoming appointments, meetings, and so on. See “Using Reminder Messages” on [page 72](#).
- **Pages:** Announcements sent over phone speakers or external speakers. See “Paging Other System Users” on [page 73](#).
- **Voice messages:** System voice mail messages.

## NOTE

Because a variety of voice mail products work with the MiVoice Office 250, this guide does not include voice mail instructions. For voice mail instructions, refer to the voice mail user guide for your system. For example, refer to the *Mitel NuPoint Unified Messaging User Guide* on the [Mitel Web site](http://edocs.mitel.com) (<http://edocs.mitel.com>). Contact your system administrator for more information about your voice mail system.

## Leaving Messages at Other Extensions

You can leave inter-station or voice mail messages for other internal parties.

### To leave an inter-station or voice message for a busy IC extension:

1. Press  (Message) or the **LEAVE MESSAGE** menu button. HANG UP OR WAIT FOR MSG CENTER appears.
2. Do one of the following:
  - Hang up to leave an inter-station message. MESSAGE LEFT FOR <name> appears.
  - Stay on the line to connect to the message center (usually voice mail).

### To leave an inter-station message without placing an internal call:

1. Dial **367** (Leave Message), or press  (Message), and then press the **LEAVE MESSAGE** menu button. LEAVE MESSAGE ON EXTENSION appears.
2. Enter the extension number. MESSAGE LEFT FOR <name> appears.

# Viewing and Responding to Messages

When you have waiting messages, the  (Message) button and Message/Ring Indicator flash and the display shows the number of waiting messages.



**NOTE**

If your handset or speakerphone is off-hook when you view an inter-station message, you automatically call the party who left the message.

The display shows new messages as follows:

- Inter-station messages sent by other internal parties are indicated by the party's programmed user name.
- Voice messages are indicated by FROM MBOX <your extension number>.

**To view or respond to messages:**

1. With the handset on-hook, press  (Message) or the **VIEW MESSAGE** menu button. Messages are displayed as first in/first out. If there is more than one message, you can repeatedly press  (Message) to scroll through the messages.
2. When the desired message is displayed, press #, or lift the handset for privacy, and then press # to respond. [If your handset is off-hook and you press  (Message), you automatically place a call to the party or message center that left the message.]

## Canceling Messages Left at Other Extensions

You can cancel messages left at other extensions.

**To cancel a message left at another extension:**

1. Dial **366** or press  (Message), and then press the **CANCEL MESSAGE** menu button. CANCEL MESSAGE ON EXT # appears.
2. Enter the extension number where you left the message. MESSAGE CANCELED FOR <name> appears.

## Deleting Waiting Inter-Station Messages

You can delete waiting inter-station messages.

**NOTE**

To delete waiting voice messages, you must connect to your voice mailbox.

**To delete waiting inter-station messages:**

1. Press  (Message) or the **VIEW MESSAGE** menu button. MSG <message information> appears.
2. Press \* or the **DELETE** menu button to delete the displayed message.

## Using Do-Not-Disturb (DND)

You can use DND to stop calls and pages to your extension. When activated, internal calling parties see your selected DND message. DND does not block queue callbacks, recalls, and incoming external calls. The following table shows the 20 default DND messages. If your system administrator changes your DND messages, you can record the new messages in the “New Message” column for reference.

Code	Default Message	New Message	Code	Default Message	New Message
01	Do-Not-Disturb		11	Out of Town 'Til	
02	Leave a Message		12	Out of Office	
03	In Meeting Until		13	Out Until	
04	In Meeting		14	With a Client	
05	On Vacation/ Holiday 'Til		15	With a Guest	
06	On Vacation/ Holiday		16	Unavailable	
07	Call Me At		17	In Conference	
08	At the Doctor		18	Away from Desk	
09	On a Trip		19	Gone Home	
10	On Break		20	Out to Lunch	

You can enter a second line of text (up to 20 characters) for DND messages. For example, if you select IN MEETING UNTIL, you can enter “3:30” on the second line. When other internal parties try to call you, their displays show “IN MEETING UNTIL 3:30.”

### To turn on DND:

1. Press the **DND** button. SELECT DND MSG # (01-20) appears.
2. Do one of the following:
  - Press ▲ (Up) or ▼ (Down) to scroll through the messages.
  - Enter the two-digit number for the DND message from the preceding table.
  - Press the **SCROLL** menu button, and then press the **PREVIOUS** or **NEXT** menu buttons to scroll through the list.
3. If applicable, enter the additional text for the DND description. See “Using the Dialpad Buttons to Enter Characters” on [page 24](#) for dialpad character descriptions.
4. Press  (Speaker) or the **ACCEPT** menu button.

### To turn off DND:

Press the DND button, or press the DND menu button, and then press DND OFF. DO-NOT-DISTURB OFF appears.

## Using Reminder Messages

You can use Reminder messages to alert you at a selected time, up to 24 hours in advance. At the selected time, the Reminder message signals you with eight short tones and your display shows the message, even if you are on a call.

The following table shows the 20 default Reminder messages. If your system administrator changes your Reminder messages, you can record the new messages in the “New Message” column for reference.

Code	Default Message	New Message	Code	Default Message	New Message
01	Meeting		11	Call Engineering	
02	Staff Meeting		12	Call Marketing	
03	Sales Meeting		13	Call Accounting	
04	Cancel Meeting		14	Cancel DND	
05	Appointment		15	Cancel Call Fwd	
06	Place Call		16	Take Medication	
07	Call Client		17	Make Reservation	
08	Call Customer		18	Review Schedule	
09	Call Home		19	Lunch	
10	Call Corporate		20	Reminder	

### To set a Reminder message:

1. With the handset on-hook, dial **305**. SELECT REMINDER MESSAGE # (01-20) appears.
2. Do one of the following:
  - Enter the two-digit number for the Reminder message from the preceding table.
  - Press ▲ (Up) or ▼ (Down) to scroll through the messages.
3. Press # or the **ACCEPT** menu button to select the message.
4. Enter the time you wish to receive the message in hours and minutes (for example, **0900** or **900** for **9:00**). Then press #. The display shows the Reminder message state.
 

*If your system is set for 24-hour format, enter the applicable time (1400 = 2:00 P.M.).*

*If your system is set for 12-hour format, press 1 for A.M. or 2 for P.M.*

### To cancel all Reminder message requests:

With the handset on-hook, dial **306**. REMINDER MSGS CANCELED appears.

### To clear a received Reminder message:

With the handset on-hook, press \*.

## Paging Other System Users

You can place page announcements through phone speakers or external speakers (if applicable). Your system may use page zones to prevent announcements from transmitting through every phone in the system. Each page zone contains a different combination of extensions and external paging equipment.

Contact your system administrator for page zone information. You can use the following table to save the page zone information for future reference.

Page Zone Name	Number	Description

## Placing a Page Announcement

The following instructions describe how to place a page announcement.

**To place a page announcement:**

1. Press **7**.
2. Enter the page-zone number (**0** to **9**).
3. Wait for the tone, make your announcement, and then hang up.

## Enabling or Disabling the Page Feature

You can enable or disable the Page feature for your extension. If your extension is assigned to more than one page zone, the Page on/off feature code enables or disables your extension for all page zone (you cannot select individual zones).

**To enable or disable paging for your IP phone:**

Dial **325** to enable paging. PAGE RECEIVE ON appears. Dial **325** again to disable paging.





# Hunt Groups

Hunt groups are groups of internal parties (agents) who share a common (hunt group) extension number. Calls can either be placed to the hunt group (using the hunt group extension number) or to a specific agent (using the agent's extension number). Hunt groups are programmed by the system administrator.

Hunt groups types are either "UCD" or "ACD."

- **UCD Hunt Groups:** Uniform Call Distribution (UCD) agents do not log in to the hunt group to receive calls.
- **ACD Hunt Groups:** Automatic Call Distribution (ACD) agents log in to the ACD hunt group to receive calls. Calls are distributed by either Agent IDs or extensions:
  - *Agent IDs:* Each agent is assigned an Agent ID number for logging in to the hunt group (see the next section). Hunt group calls are distributed to logged-in agents according to their Agent ID number instead of their extension number. Agents can log in to any ACD hunt group phone.
  - *Extensions:* Hunt group members do not use Agent IDs, and calls are distributed to phones where the agents are logged in.

## Logging in to ACD Hunt Groups

You must log in to an ACD hunt group to receive hunt group calls. To stop calls, you either log out of the ACD hunt group or divert calls. See "Diverting Hunt Group Calls" on [page 77](#).

<b>NOTES</b>	<p>Only one agent can be logged in to a phone.</p> <p>If the ACD Agent ID Automatic Connect option is enabled for your hunt group and you are using a headset, you are automatically connected to waiting calls when you log in. The first call you receive after you log in rings until you answer it; however, you are automatically connected to subsequent calls.</p>
--------------	---

**To log in to or out of all ACD hunt groups in which you are a member:**

Dial **328** to log in to ACD hunt groups followed by your Agent ID, if necessary. AGENT LOGGED INTO ALL ACDS appears. Dial **328** again to log out of all ACD hunt groups.

**To log in to one or more ACD hunt groups:**

1. Dial **326**. AGENT LOGIN ACD HG # appears.
2. Do one of the following:
  - Enter the ACD hunt group number.
  - Press # to log in to all of your ACD hunt groups.

The display shows AGENT LOGIN AGENT ID.

3. Enter your Agent ID (if applicable), or press # if you do not have an agent ID. The display shows the log in status for one or all hunt groups.

### Logging out of ACD Hunt Groups

You can log out of all ACD hunt groups at once or log out of each hunt group one at a time.

**To log out of one or more ACD hunt group:**

Do one of the following:

- Dial **328** to log out of all of your ACD hunt groups. The display shows AGENT LOGGED OUT OF ALL ACDS.
- Dial **327** to log out of one hunt group at a time.

*If you were logged in to only one hunt group, the display shows AGENT LOGGED OUT OF HUNT GROUP <number>.*

*If you were logged in to more than one hunt group, the display shows AGENT LOGOUT HG #. Enter the extension number of the ACD hunt group.*

### Stopping the ACD Hunt Group Wrap-up Timer

Each time you end an ACD hunt group call, a wrap-up timer starts. The default wrap-up time is 15 seconds. Your system administrator can change the wrap-up timer settings.

Until this timer expires, you will not receive another hunt group call; however, you can stop the wrap-up timer to allow calls to your extension.

**To stop the wrap-up timer:**

With the handset on-hook, dial **329**. The display shows ACD WRAP-UP TERMINATED.

## Other Hunt Group Features

The following features can be used by ACD or UCD hunt groups.

### Requesting Agent Help

You can use Agent Help to request help from a designated “Agent Help Extension” (usually your supervisor) during a call. When your request call rings at the Agent Help Extension, the supervisor can join the call or reject the request.

**NOTE**

Agent Help is not supported on peer-to-peer (P2P) calls. Contact your system administrator for more information.

**To use Agent Help:**

1. While you are on a hunt group call, press **ⓧ** (Special), and then dial **375**.

**NOTE**

If you hear repeating tones, one of the following has occurred:

- The feature is not available at your IP phone.
- You already have four parties in your call.
- Not enough system circuits are currently available.
- The Agent Help Extension is in DND.

2. If not preprogrammed, dial the Agent Help extension number.

*If the Agent Help Extension accepts the call, AGENT HELP IN PROGRESS appears.*

*If the Agent Help Extension rejects the call, AGENT HELP REJECTED appears.*

### Diverting Hunt Group Calls

You can temporarily divert hunt group calls, preventing hunt group calls to your extension.

**To divert hunt group calls:**

Dial **324** to divert calls. The display shows the feature state DIVERT HUNT GROUP CALLS. Dial **324** again to program your IP phone to accept calls.

# Hunt Group Supervisor Features

The following features can be used by hunt group supervisors only.

## Accepting or Rejecting Agent Help Calls

Supervisors can accept or reject Agent Help calls.

**To accept an Agent Help request:**

Answer as usual. Your microphone is automatically muted.

**To reject an Agent Help request:**

Dial **376** or press the **REJECT HELP** menu button. AGENT HELP REJECTED appears.

## Monitoring Calls

You can use Station Monitor to connect to a hunt-group call and hear both parties, but you cannot be heard by either one. Station Monitor stops if the hunt group member terminates or transfers the call. You can barge-in to or “steal” monitored calls, as described in the following sections. You can also record the call. See “Using Meet-Me Conferencing” on [page 54](#) for more information about recording calls.

**NOTE**

Station Monitor is not supported on peer-to-peer (P2P) calls. Contact your system administrator for more information.

**To use Station Monitor:**

Dial **321** or press the **SIL MONITOR** menu button, and then enter the extension number. MONITORING EXT *<number>* appears. Monitored hunt group members may hear an “activation tone” when the feature is activated.

## Stealing Hunt Group Calls

While monitoring a hunt group call, you can “steal” the call from the hunt group member, which disconnects the call from the agent and transfers the call to your extension.

**To steal a hunt group call:**

Dial **387** or press the **STEAL** menu button. CALL STOLEN FROM EXT *<number>* appears.

## Using Barge-In

While monitoring a hunt group call, you can use Barge-In to join the call.

### To monitor and/or barge in on a call:

1. **To use the speakerphone:** While on hook, dial **321**. You hear a confirmation tone. ENTER EXT TO MONITOR appears.
 

**To use the handset:** Lift the handset, and then dial **321**. You hear a confirmation tone. ENTER EXT TO MONITOR appears.
2. Dial the extension number (or press the lit station speed-dial or PKM button) of the station to be monitored. You are automatically connected to the call. MONITORING (*extension number*) appears.
3. While silent monitoring a call, you have the following options:
  - *To barge in on a call*, dial **386** or press the **BARGE-IN** menu button. BARGE-IN IN PROGRESS appears. While on a call, you can monitor, record, or steal the call by entering the appropriate feature code or by pressing the appropriate menu button.
 

*To return to silent monitoring of the call*, dial **386** again or press the **MONITOR** menu button.

*To record the call*, dial **385** or press the **RECORD CALL** button.
  - *To record a call*, dial **385** or press the **RECORD** menu button. MONITORING (*extension number*) appears. While on a call, you can monitor or steal the call by entering the appropriate feature code or by pressing the appropriate menu button.
 

*To stop recording the call*, dial **385** again or press the **STOP RECORDING** menu button.
  - *To steal a call*, dial **387** or press the **STEAL** menu button. CALL STOLEN FROM (*extension number*) appears. The hunt group member's display shows CALL STOLEN BY (*extension number*). After the supervisor steals the call, the call becomes a regular call. While on a call, you can record the call by dialing **385** or by pressing the **RECORD** menu button.
  - *To join and record a call*, dial **386** or press the **JOIN AND RECORD** menu button, and then dial **385**. BARGE-IN IN PROGRESS appears. While on a call, the supervisor can monitor, stop recording, or steal the call by entering the appropriate feature code, or by pressing the appropriate menu button.
 

*To stop recording the call*, dial **385** again, or press the **MONITOR** or **STOP RECORDING** menu button.
4. **To terminate any of the features:** *If off hook*, hang up or enter the specific feature code of the feature you want to terminate. *If on hook*, press the **Speaker** button or enter the specific feature code of the feature you want to terminate.



# Cordless Devices

You can use the cordless handset and cordless headset to move around within your office or adjacent offices. The cordless headset and handset are optional accessories, ordered separately. For more information, contact your system administrator or local Mitel provider. Both cordless devices connect to your IP phone through the cordless module, which attaches to the back of the IP phone. The following two Cordless Module types are available:

- Digital Enhanced Cordless Telecommunications (DECT)
- Bluetooth®.

The DECT Cordless Module works with the Mitel DECT Cordless Handset and Mitel DECT Cordless Headset. The Bluetooth Module works with the Mitel Bluetooth Handset and most third-party Bluetooth headsets.

The Mitel Cordless Handsets (both DECT and Bluetooth) recharge in the handset cradle. The Mitel Cordless Headset (DECT only) rests and recharges in a headset cradle that attaches to the side of the phone.

The Cordless Devices Application provides access to the configuration settings and information screens that apply to the cordless module and accessories. For more information, see “Pairing the Cordless Module and Devices” on [page 84](#).

## NOTE

Since only one module type can be attached to the phone at any given time, you cannot, for example, use a 5310 Conference Module when a Cordless Module is attached.

The cordless module is shown here. The IP phone features are explained below.



Feature	Function
1 – Cordless Module	Attached to the back of the IP phone, the module contains a light-emitting diode (LED) indicating that a cordless device is in use; also indicates the pairing of module and a cordless device.

## Cordless Devices

---

Feature	Function
2 – Cordless Headset (DECT headset pictured)	Cordless handsfree operation for calls. If you are using the cordless headset, you do not need to use the handset.
3 – Cordless Headset Charging Cradle (DECT only)	Provides power to recharge the cordless headset battery.
4 – Cordless Handset Charging Cover	Provides power to recharge the cordless handset battery. Replaces the cover supplied with the IP phone for corded handsets.
5 – Cordless Handset	Cordless operation for handset calls. (You can transfer from the IP phone handset to the cordless headset at any time.)



## Cordless Module

The cordless module is shown here.

### ⚠ CAUTION

**Phone Damage Hazard.** Attempting to remove the back plate on the IP phone to install the cordless module before disconnecting the IP phone power supply may damage the IP phone. For information about installing the cordless module, refer to the installation documentation that is shipped with the unit.



Feature	Function
1 – Cordless Module pairing button	Initiates pairing between the cordless module and a cordless device.
2 – Cordless Headset Cradle cable (DECT only)	Connects to the cordless module to provide power to the charging cradle.

## Handset and Headset Combinations

The following combinations of corded and cordless headset and handset are supported on the 5360 IP Phone:

- Corded handset only
- Corded handset and corded headset
- Cordless handset only
- Cordless handset and cordless headset
- Corded handset and cordless headset
- Corded headset and cordless handset

The DECT Cordless Handset, DECT Cordless Headset, and Bluetooth Handset are all Mitel-branded accessories available only from Mitel. Bluetooth headsets are third-party accessories available from a variety of manufacturers.

## Pairing the Cordless Module and Devices

Before using the cordless handset or headset, each device must establish communication with the cordless module using a procedure called pairing.

### NOTES

- An IP phone can have only one cordless handset and one cordless headset.
- A cordless handset or headset can be paired with only one IP phone at a time.
- Pairing a new cordless handset or headset with the IP phone overwrites the configuration of any previous handset or headset.
- Pairing cannot be performed when the cordless device is already in use.

## Pairing a DECT Cordless Accessory with a DECT Cordless Module

### To pair a DECT cordless device:

1. Ensure that the battery of the cordless device to be paired is at least partially charged.
2. Press and hold down the pairing button on the back of the cordless module (see [page 83](#)) for five seconds to activate phone pairing mode. The LED on the cordless module blinks. The Cordless Devices application opens on the IP phone and prompts you to press the pairing button on the cordless device.
3. Press and hold down the hookswitch on the cordless handset or headset for five seconds to activate the device pairing mode. The LED on the cordless device blinks. After a moment, the Cordless Devices application displays information for the device to be paired.

### NOTE

If the LED on the Cordless accessory does not start to blink after 10 seconds, the accessory requires charging or is still in factory battery saving mode (handset only). Place the accessory on the charger and charge. The green LED starts to flash indicating that the accessory is charging. It could take up to 60 minutes for the green LED to start flashing. Allow the accessory to fully charge, approximately 3 hours.

4. Press **Yes** to confirm pairing. The Cordless Devices application confirms the pairing by displaying the paired device name and its battery level indicator and the number of devices paired.
5. Press **Close** to exit.

## Pairing a Bluetooth Accessory with a Bluetooth Module

### NOTES

- An IP phone can have one Bluetooth Handset and up to five Bluetooth headsets (or up to six headsets if no handset is paired).
- To pair a new Bluetooth Handset, you must first unpair the existing Bluetooth Handset.
- Pairing cannot be performed when a Bluetooth device is already in use.

### To pair a Bluetooth accessory:

1. Ensure that the battery of the Bluetooth device to be paired is at least partially charged.
2. Press and hold the pairing button on the back of the Bluetooth Module for 5 seconds to activate phone pairing mode. The LED on the Bluetooth Module blinks. The Cordless Devices application opens on the phone and prompts you to place the accessory in pairing mode.
3. For Mitel Bluetooth Handsets: Press and hold the hookswitch on the side of the Bluetooth Handset (see [page 83](#)) for 5 seconds to activate accessory pairing mode. The

LED on the handset blinks. The pairing confirmation window on the IP Phone appears, displaying the product name for the device to be paired.

**NOTE**

If the LED on the handset does not start to blink after 10 seconds, the handset requires charging or is still in factory battery saving mode. Place the handset on the charger. The green LED starts to flash indicating that the handset is charging. It could take up to 60 minutes for the green LED to start flashing. Allow the handset to fully charge, approximately 3 hours.

**For third-party Bluetooth headsets:** Follow the manufacturer's instructions to place the Bluetooth headset in pairing mode. The pairing confirmation window on the IP Phone appears, displaying the product name for the device to be paired.

4. Press **Yes** to confirm the pairing. The Cordless Devices application prompts you to enter a passcode.
5. Enter a valid passcode for the Bluetooth device (default is 0000) using the keyboard on the display, and press **OK**.

**For third-party Bluetooth headsets:** An "Auto Connect" window displays. Press Yes if the phone will not be shared with other users; press No if the phone will be shared with other users and multiple headsets.

6. The LED on the Bluetooth Module lights and remains lit for a few seconds and then resumes normal behavior. The Bluetooth device is paired to the Bluetooth Module.
7. Press **OK** to return to the Cordless Devices application.
8. Press **Close** to exit the application.

## To unpair a cordless device:

1. Press  (Applications), and then press **Cordless Devices**.
2. Press the device name you want to unpair. The information screen for the selected device appears.
3. Press **Unpair this Device**. If the device is in use, an error message appears. Otherwise, the device is unpaired, removed from the display, and can no longer be used to interact with the IP phone.
4. Press **Close**.

## Cordless Module LED Indicators

The cordless module has a blue LED that indicates the current status of the module. The handset is blinking, when the LED is on and off for an equal amount of time.

Blue LED	Function
Solid	Audio is active between the module and either the handset or headset.
Blinking	Pairing mode is active or a firmware upgrade is in progress.
Off	No audio is active.
Solid for two seconds	Pairing is successful.

## Using a Cordless Device as a Remote Control

When not being used to talk, the cordless handset/headset buttons can act as a remote control device to change display contrast, volume, and mute settings on the host IP phone. For example, in a remote handsfree conference setting, you can use the Volume and Mute buttons on a cordless device to adjust speaker levels and mute the microphone on an IP phone that is not within his reach.

## Using the Mute Key on a Cordless Device

When using a Mitel-branded cordless accessory, the Mute key on the cordless accessory is synchronized with the Mute key on your phone. Pressing the Mute key on either the phone or the accessory also controls the Mute function on the other device.

There is no synchronization between a third-party Bluetooth headset mute control (if one is available) and your phone Mute key. The procedure for muting a Bluetooth headset depends on the headset manufacturer. Some headsets have a mute control and some do not. You can, however, use the Mute key on your phone to mute a conversation on any type of Bluetooth headset.

## Using the Volume Keys on Cordless Device

When using a Mitel-branded cordless accessory, the Volume keys on the cordless accessory are synchronized with the Volume keys on your phone. Pressing the Volume keys on either the phone or the accessory also controls the Volume function on the other device.

When using a third-party Bluetooth headset, the volume control on the headset (if one is available) is not synchronized with the Volume keys on your phone. Pressing the Volume keys on the phone does not change the headset volume.

## Alerting Tones and LEDs

The cordless devices provide the following alerting tones:

Feature	Function
Mute key on cordless device ON/OFF	Two-pitch tone occurs immediately. Reminder tone occurs 30 seconds after activation and then regularly until deactivated
Mute key on phone ON/OFF	No immediate tone. Reminder tone occurs 30 seconds after activation and then regularly until deactivated.
Low battery (within 10 minutes left)	Three beeps and 20 second pause repeated three times.
Low battery (within 2 minutes left)	Three rapid beeps and 1.5 second pause repeated three times.
Out of range	Repetitive 3-pitch tone until you are back in range.

### NOTES

Audio indications are heard in the handset only when it is in use, and may interrupt voice transmission.

If you are out of range for more than 10 seconds, any call that is in progress is dropped and not recovered.

## Low Battery Level

When the battery of a cordless device reaches a near-critical level, the IP phone displays a warning. Until the battery is recharged (or until it becomes fully discharged), the warning is repeated at each new call. To continue with a call while charging the cordless device, switch to speakerphone and then cradle the cordless device.

## Using the Mitel Cordless Handset

The cordless handset, shown below, provides office mobility, allowing you to place and answer calls while away from your desk. Replacing the standard corded handset, the cordless handset contains a rechargeable battery that charges in the handset cradle when not in use. To use the cordless handset (whether DECT or Bluetooth), you must pair the handset with the IP phone. For more information, see “Pairing the Cordless Module and Accessories” on [page 84](#).



### Cordless Handset Features

Cordless handset elements are shown in the following table.

Feature	Function
1 – Cordless Handset LED	Blue: LED indicating the status of the handset. Green: LED indicating the status of the handset battery. For more information see <a href="#">page 89</a> .
2 – Hookswitch and pairing button	Lifting the handset from the cradle activates the handset. If the handset is already out of the cradle, pressing the hookswitch takes the handset off-hook. Pressing the hookswitch again returns it to on-hook. Pressing the hookswitch while on a speakerphone all, moves the call to the cordless handset.
3 – Mute button	Mute allows you to turn the microphone off during a call.
4 – Volume Up and Down button	Up and Down buttons provide volume control for the ringer and handset/headset.

## Answering Calls

The following instructions describe how to answer a call.

### To answer a call:

Do one of the following:

- Lift the cordless handset.
- If the handset is already out of the cradle, press the hookswitch button on the handset.

## Hanging Up

If you are out of range for more than 10 seconds, any call that is in progress is dropped and not recovered.

### To hang up:

Do one of the following:

- Replace the cordless handset in the cradle.
- Press the hookswitch button on the handset.

## Cordless Handset Alerting Tones and LEDs

The handset provides the following alerting tones:

Feature	Function
<b>Mute</b> key on cordless device ON/OFF	2-pitch tone occurs immediately. Reminder tone occurs 30 seconds after activation and then regularly until deactivated
<b>Mute</b> key on Phone ON/OFF	Immediate tone with Bluetooth; no immediate tone with DECT. Reminder tone occurs 30 seconds after activation and then regularly until deactivated.
Low battery (within 10 minutes left for DECT and within 20 minutes left for Bluetooth)	3 beeps and 20 second pause repeated 3 times.
Low battery (within 2 minutes left)	3 rapid beeps and 1.5 second pause repeated 3 times.
Out of range	<b>DECT:</b> Repetitive 3-pitch tone until you are back in range. Note: If you are out of range for more than 10 seconds, any call that is in progress is dropped and not recovered. <b>Bluetooth:</b> Single 3-pitch tone to indicate that you are out of range. <b>Note:</b> All Bluetooth devices will drop any call in progress if the maximum range is exceeded.

### NOTE

Audio indications are heard in the handset only when it is in use and may interrupt voice transmission.

The handset has two LEDs:

- Blue – indicates the operational status of the handset.
- Green – indicates the status of the electrical charge of the battery.

The handset is blinking, when the LED is on and off for an equal amount of time. The handset is winking, when the LED is on for a short period of time and off for a longer period of time.

LED Color	LED State	Indicates:
Blue	Solid	Handset is muted.
	Blinking	Handset is in pairing mode.
	Winking	Active audio path between handset and module.
	Off	No audio path between handset and module. Battery is dead.
Green	Solid	Battery is fully charged.
	Blinking	Battery is charging.
	Off	When handset is cradled and the LED does not flash or illuminate, this indicates an absence of battery power. During the first 30 – 60 minutes that the light is off, the battery may be trickle charging. If that is the case, the LED resumes normal behavior within that 60-minute period. If the LED remains off for more than 60 minutes, then either the battery is no longer chargeable or there is a problem in the charging circuit.

**NOTE** It is normal for the handset LED to cycle between blinking and solid as battery charge is maintained.



## Using the Mitel DECT Cordless Headset

**NOTE**

This section applies only to the Mitel DECT Cordless Headset. It does not apply to third-party Bluetooth headsets.

The cordless headset offers the same capability as the cordless handset to make and answer phone calls away from your desk, while adding the convenience of hands-free operation.

When not in use, the cordless headset sits in the headset charging cradle. For more information on alerting tones and LEDs, see “Alerting Tones and LEDs” on [page 86](#).

To use the cordless headset, you must pair the headset with the IP phone. For more information, see “Pairing the Cordless Module and Devices” on [page 84](#).

### Cordless Headset Features

The cordless headset is shown here.

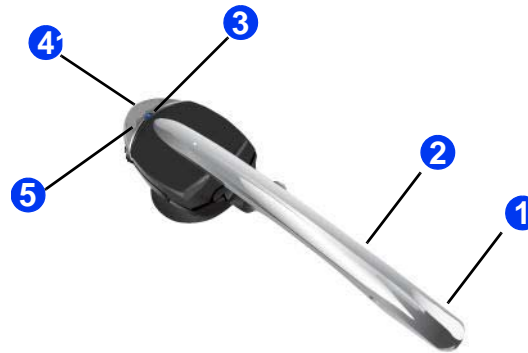

- |                            |                                   |
|----------------------------|-----------------------------------|
| 1 – Microphone             | 4 – Volume control                |
| 2 – Boom arm               | 5 – Hookswitch and pairing button |
| 3 – Linked Indicator (LED) |                                   |

### Answering Calls

The following instructions describe how to answer a call.

**To answer a call:**

Do one of the following:

- Lift the cordless headset from the cradle.
- If the headset is already out of the cradle, press the hookswitch button on the headset.

### Hanging Up

If you are out of range for more than 10 seconds, any call that is in progress is dropped and not recovered.

**To hang up:**

Do one of the following:

- Replace the cordless headset in the cradle.
- If the headset is already out of the cradle, press the hookswitch button on the headset.

## Cordless Headset Alerting Tones and LEDs

The cordless headset provides the following alerting tones:

Mute ON/OFF	2-pitch tone occurs immediately. Reminder tone occurs 30 seconds after activation and then regularly until deactivated.
Mute key on Phone ON/OFF	No immediate tone. Reminder tone occurs 30 seconds after activation and then regularly until deactivated.
Low battery (within 10 minutes left)	3 beeps and 20 second pause
Low battery (within 2 minutes left)	3 rapid beeps and 1.5 second pause
Out of range	Repetitive 3-pitch tone until you are back in range. Note: If you are out of range for more than 10 seconds, any call that is in progress is dropped and not recovered.

There are two LEDs associated with the cordless headset:

- Blue – Indicates the operational status of the headset
- Green – Indicates the status of the electrical charge of the battery

The handset is blinking, when the LED is on and off for an equal amount of time. The handset is winking, when the LED is on for a short period of time and off for a longer period of time.

Led Color	LED State	Indicates
Blue (on headset)	Solid	Headset microphone is muted.
	Blinking	Headset is in pairing mode.
	Winking	Active audio path between Headset and Module.
	Solid for 2 seconds	Indicates one of the following: <ul style="list-style-type: none"> <li>• Pairing successful</li> <li>• New battery installed</li> </ul>
Green (on cradle)	Solid	Battery is fully charged.
	Blinking	Battery is charging.
	Winking	Indicates low voltage when headset is uncradled.
	Off	When headset is cradled, indicates battery is not charging.

---

## Using A Bluetooth Headset

A third-party Bluetooth headset offers some of the same capability as the Bluetooth Handset to make and answer phone calls away from your desk while adding the convenience of handsfree operation.

To use a Bluetooth headset, you must first pair the headset with the Bluetooth Module on your phone. For more information, see “Pairing the Cordless Module and Devices” on [page 84](#).

**NOTE**

If you move out of range of the phone while connected using Bluetooth, you will notice that the audio quality quickly degrades. If you do not move back within range within about 10 seconds, the call is dropped.

**NOTE**

To switch from the Bluetooth Headset to the 5360 IP Phone speaker press the hookswitch twice on the Bluetooth headset.

**NOTE**

The specific operation of third-party Bluetooth headsets can vary somewhat by manufacturer and model. Refer to the documentation accompanying the Bluetooth headset for details on operation, alerting tones, LEDs, and charging. Note that all Bluetooth devices will drop any call in progress if the maximum range is exceeded.

## Answer a Call

To answer a call:

- Press the hookswitch button on the headset.

## Hang Up

To hang up on a call:

- Press the hookswitch button on the headset.

## Using the Cordless Devices Application

The Cordless Devices Application provides access to module information and pairing for handset or headsets.

**To access the Cordless Devices Application, do one of the following:**

- Press  (Applications), and then press **Cordless Devices**.
- Press a feature button (key) you have programmed as the Cordless Devices Application key.

For information about programming feature keys, see [page 30](#).

### NOTE

When the pairing button on the Cordless Module is pressed, or when the battery level of a cordless accessory is critically low, the IP phone will automatically open the Cordless Devices Application.

## Viewing Cordless Module Information

You can use the Cordless Module Application to view protocol, firmware, and hardware information about the module.

**To view cordless module information:**

1. Press  (Applications), and then press **Cordless Devices**.
2. Press **Cordless Module Info**. Device information appears on the screen.
3. Press **Close** to exit.

## Low Battery Level

When the battery of a Mitel cordless device reaches a near-critical level, the phone displays a warning. Until the battery is recharged (or until it becomes fully discharged), the warning is repeated at each new call made using the Prime Line. To continue with a call while charging the cordless accessory, switch to speakerphone and then cradle the cordless accessory.

## Enabling/Disabling Auto-Connect on a Bluetooth Headset

When pairing a Bluetooth headset with the Bluetooth Module installed on your phone, you are given the option to enable the Auto-Connect feature—a feature whereby, if a previously paired Bluetooth device comes into range of the module, it will automatically be connected.

If desired, you can turn this feature on or off using the Cordless Devices application. You should turn on the feature if you are the only user of the phone. If you share the phone, as is sometimes the case in a call center environment, you should turn off the feature.

**To turn the Auto-Connect feature on or off:**

1. Access the Cordless Devices Application.
2. Press the desired Bluetooth headset, and then select **Auto-connect (On)** or **Auto-connect (Off)** to toggle the feature to the desired setting.
3. Press **Close** to exit.

## Connecting/Disconnecting a Bluetooth Headset

You can use the Cordless Device Application to connect or disconnect any Bluetooth headset that requires manual connection.

**To connect or disconnect a Bluetooth headset:**

1. Access the Cordless Devices Application.

2. Press the desired Bluetooth headset, and then select **Connect** to connect the headset or **Disconnect** to disconnect the headset.
3. Press **Close** to exit.

## Editing a Bluetooth Headset Name

If desired, you can enter or edit a name to help distinguish the headset device from others that may have the same device name. Once you have programmed a name, it is displayed in brackets below the manufacturer name in the details window, and it replaces the headset manufacturer name on the main Cordless Devices application window.

### To edit a name:

1. Access the Cordless Devices Application.
2. Press the desired Bluetooth headset, and then select **Edit Name**.
3. Enter a new name or edit the existing name using the keyboard on the display, and then press **OK**.
4. Press **Close** to exit.



# Troubleshooting

The following sections can help you solve problems that you may be experiencing with your IP phone. Troubleshooting topics include:

- **Contact Information:** Information about system administrator contacts.
- **Error Messages:** Error messages and descriptions.
- **Troubleshooting Tips:** Possible problems and methods to solve them.

## Contact Information

Your system administrator can help you with items such as changing your settings or modifying phone features. System administrator duties include:

- Adding new user accounts.
- Setting the date and time.
- Programming System Speed-Dial numbers.
- Making database changes, such as changing user names and extension numbers.

Contact your system administrator with questions that are not covered in this user guide. If you need further assistance, you can find provider information on the [Mitel Web site](http://www.mitel.com) (www.mitel.com). All sales, service, and support are coordinated at the local level.

## Error Messages

The following error messages may appear when using your IP phone.

Message	Reason
CANNOT ACCESS FEATURE	The feature is enabled but other feature-related conditions were not met. Make sure that all feature-related conditions are met and retry.
CANNOT ACCESS RESERVED FEATURE	Your system does not support the feature. Contact your system administrator for more information.
INVALID FEATURE CODE	The feature code entered does not exist. Retry using the correct feature code (see <a href="#">page 27</a> ).
INVALID EXTENSION NUMBER	The extension number entered does not exist. Retry using a valid extension number.
NO UPDATE PERFORMED	The feature was not completed or one or more feature conditions were not met.

## Troubleshooting Tips

The following table includes troubleshooting tips for phone and system features.

<b>NOTE</b>	You can often correct problems that you may be experiencing by resetting the IP phone to the default settings. See “Resetting the IP Phone to the Default Settings” on <a href="#">page 30</a> .
-------------	--

Problem	Possible Solution
The IP phone is not working properly.	Contact your system administrator.
I cannot use one or more of the features described in this guide.	The feature may not be enabled. Contact your system administrator for more information.
I cannot program System Speed-Dial numbers.	Your system administrator programs System Speed Dial numbers.
I cannot change the time and date on the phone display.	Your system administrator programs the time and date. Contact your system administrator if you notice that the date and time are incorrect.
I am experiencing audio problems on my phone such as echo, distorted sound, or choppiness.	Contact your system administrator if you are having audio problems.
The name on the display is incorrect.	Your system administrator assigns display names.
I cannot use the local telephone company star codes (for example, *82, *69) when I press the <b>Outgoing</b> button or use the Outgoing Call access code ( <b>8</b> is the default code) when calling an external number.	Rather than pressing the <b>Outgoing</b> button or <b>8</b> to access an outside line, you must dial a Select Line Group number before you can use the star codes. For example, if your system is using the default Select Line Group numbers, dial 92001 to access that line. After you have dial tone, you can dial the star code and the number.
I cannot use the Agent Help, Record-a-Call, or Station Monitor feature.	If your system uses Peer-to-Peer (P2P) audio, you cannot use these features when you are on a P2P call. Contact your system administrator for more information.
I cannot program a Station Speed Dial number to the button I want.	Before assigning the speed-dial number to a programmable button, you must store the number with either a Station Speed-Dial bin.



Problem	Possible Solution
<p>When I try to use the Dynamic Extension Express – Handoff feature (388), the display shows NO CALL TO HANDOFF.</p>	<p>The NO CALL TO HANDOFF display indicates that the call cannot be handed off because one of the following may have occurred:</p> <ul style="list-style-type: none"> <li>• You tried to use the Handoff feature on a call that has not been routed by Dynamic Extension Express.</li> <li>• You tried to use the Handoff feature on a call that the system has not yet recognized as a valid call.</li> <li>• You tried to use the Handoff feature on an unsupported extension. The Handoff feature is supported on your main extension only.</li> <li>• You tried to use the Handoff feature on a phantom extension. The Handoff feature is not supported on phantom extensions.</li> <li>• You entered the handoff feature code at the exact time the other party on the call disconnected.</li> <li>• The call was terminated for some reason.</li> </ul>



