

INTER-TEL

**QUICK
EASY
STEPS**
for setting
up your
phone!

SEE YOUR
QUICK REFERENCE
GUIDE SECTION

Inter-Tel INT1100 User Guide



OWNER'S MANUAL

Contents

Welcome/Features	3	Phonebook	23
Quick Reference Guide	4	Storing Phone Numbers, Names, Distinctive Rings, and Speed Dial	23
Controls and Functions	5	Steps for Entering Names and Special Characters	25
Getting Started	7	Viewing the Phonebook	27
Read this First	7	Making Calls Using the Phonebook	28
Setting up the Phone	8	Speed Dialing	28
Terminology	12	Editing or Erasing a Stored Name, Phone Number, Distinctive Ring, and Speed Dial	29
Setting Caller ID Options	13	RocketDial (One Touch Dialing)	30
Selecting a Language	15	Chain Dialing	31
Basics	16	Caller ID	32
Making and Receiving Calls	16	Viewing the Caller ID List	33
Redialing a Call	17	Deleting Information from the Caller ID List	34
Ringer Volume Setup	18	Using the Caller ID Message List	35
Ringer Tone Setting	18	Call Waiting Deluxe Features	36
Distinctive Ringer Setup	19	Additional Information	37
Adjusting the Earpiece and Handset Speaker Volume	20	Changing the Digital Security Code	37
Mute Microphone	20	Installing the Beltclip	38
Tone Dialing Switch-over	21	Headset Installation	38
Traveling Out-of-Range	21	Note on Power Sources	39
Selecting a Different Channel	21	Maintenance	39
Find Handset	22	General Information	40
Flash and Call Waiting	22	Troubleshooting	41
Voice Mail LED	22	Liquid Damage	42
		Precautions & Warranty	43
		Index	45

Welcome

Congratulations on your purchase of the Inter-Tel® cordless telephone. This phone is designed and engineered to exacting standards for reliability, long life and outstanding performance. To enjoy the best performance from this phone's features, please read this manual carefully and save it for future reference.

Note: Some illustrations in this manual may differ from the actual unit for explanation purposes.



As an Energy Star® Partner, Inter-Tel has determined that this product or product models meets the Energy Star® guidelines for energy efficiency. Energy Star® is a U.S. registered mark.

Note: Energy Star® applies to INT1100 only.

Features

- 5.8 GHz Spread Spectrum Technology
- Hands Free Speakerphone in the Handset
- Caller ID and Call Waiting Caller ID
- Dynamic Memory Location for Caller ID Messages and Phonebook Locations (up to 100 numbers in total)
- Trilingual Language Option
- 3-Line, 16 Character Backlit Handset Display
- One Touch Rocket Dialing
- Call Transfer
- 32 Digit Redial / 3 Last Number Redial Locations (handset only)
- 10 Distinctive Ring Options (6 ringers and 4 melodies)
- Mute Feature
- Flash and Pause
- Find Handset
- Hearing Aid Compatible
- Tone/Pulse Dialing
- Handset Earpiece, Handset Speaker, and Ringer Volume Control
- Call Timer

Step 1 Charging the Battery

INSTALL THE HANDSET BATTERY

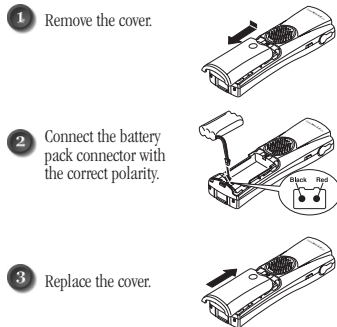
- 1 Remove the cover.
 - 2 Connect the battery pack connector with the correct polarity.
 - 3 Replace the cover.
- 

PLUG INTO AC POWER

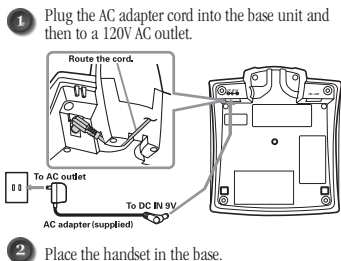
- 1 Plug the AC adapter cord into the base unit and then to a 120V AC outlet.
 - 2 Place the handset in the base.
- 

Note: You must charge the battery pack continuously for 15-20 hours before using the phone.

Step 2 Connecting

CONNECT TO A PHONE LINE

When the handset battery pack is fully charged, plug the telephone cord into the base unit and then into a telephone wall jack.

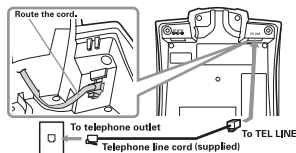

Your phone is set for tone dialing. If your local network requires pulse dialing, please see "Setting up the phone, Choose the dialing mode" in your owner's manual.

Step 3 Setting up the Caller ID Options/Language

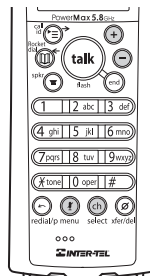

Note: Three Caller ID options are available: Auto Talk, Caller ID on Call Waiting (CIDCW) and Area Code.

TO SELECT CALLER ID OPTIONS

- 1 Press **menu/mute**.
- 2 Press **+ or -** to move the pointer to "Caller ID Setup", then press **select/ch**.
- 3 Press **+ or -** to move the pointer to an option, then press **select/ch**.
- 4 Press **+ or -** to change the option setting.
- 5 Press **select/ch** and return the handset to the base.

TO CHOOSE THE LANGUAGE

- 1 Press **menu/mute**.
- 2 Press **+ or -** to move the pointer to "Language", then press **select/ch**.
- 3 Press **+ or -** to change the option setting.
- 4 Press **select/ch** and return the handset to the base.

Controls and Functions

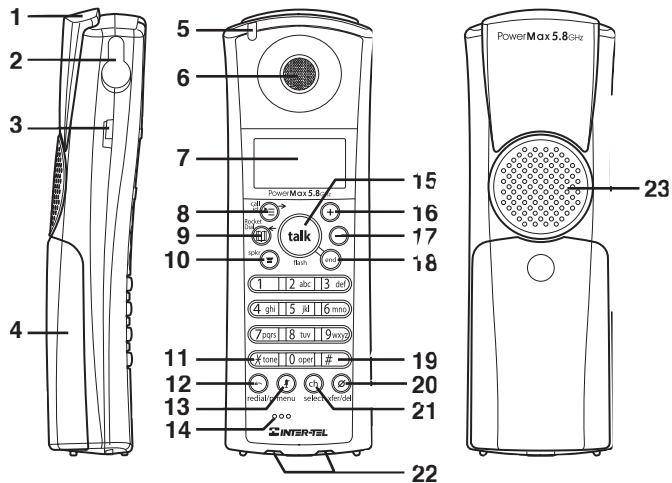

1. Handset Antenna
2. Headset Jack Cover
3. Beltclip Hole
4. Handset Battery Compartment
5. Voice Mail LED
6. Handset Earpiece
7. LCD Display
8. call id (Caller ID)/→ (right cursor) Key
9. (Phonebook)/RocketDial/← (left cursor) Key
10. spkr (speaker) Key
11. /tone Key
12. redial/p (pause) Key
13. Menu/ (mute) Key
14. Handset Microphone
15. Talk/flash Key
16. + (up) Key
17. - (down) Key
18. End Key
19. # Key
20. Xfer (transfer)/ del (delete) Key
21. Select/ch (channel) Key
22. Handset Charging Contacts
23. Hands Free Speaker

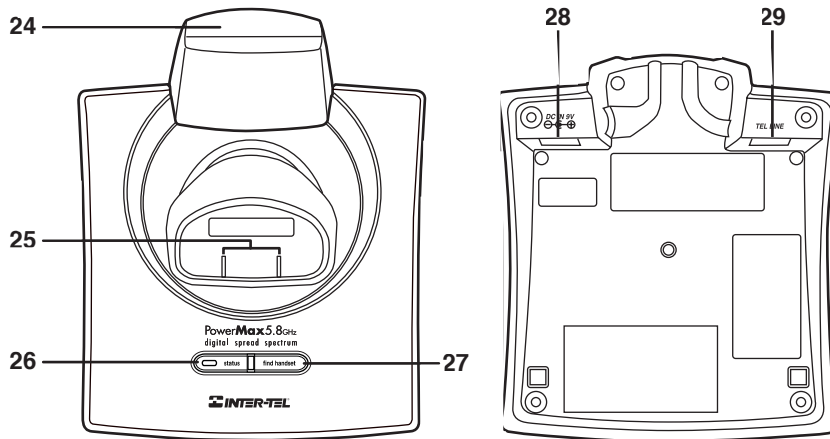

- 24. Base Antenna
- 25. Base Charging Contacts
- 26. Status LED
- 27. Find Handset Key
- 28. DC Power Input
- 29. Telephone Line Jack

Read this First

This cordless telephone must be set up before use. Follow these steps:

Step 1 (page 9)

Unpack the telephone and accessories.

Step 2 (page 10)

Next, choose the best location to set up the base unit.

Step 3 (page 11 to 14)

Then, insert the battery pack into the handset. Connect the base unit. You must charge the battery pack **for 15-20 hours before plugging into the phone line and using the phone.**

Step 4 (page 15 to 17)

Finally, set the Caller ID options, and store your area code in the memory to use the Caller ID service. Choose the language of your display.

Note: Skip the area code setting if your calling area requires 10-digit dialing.

About the digital security code

This cordless telephone uses a digital security code to prevent unauthorized access to your base unit. This security code prevents other cordless handsets from making calls through your base unit. If you want to change the security code, see page 43.



For maximum range:

- Keep the antenna free of obstruction.
- When the handset is not in use place the handset in an upright position.
- Do not hold the handset where you would block the signal.



Setting up the Phone

Do the following steps:

- A. Choose the best location
- B. Install the battery pack
- C. Connect the base unit
- D. Choose the dialing mode

A. Choose the best location

Before choosing a location for your new phone, read "Installation Considerations" on page 44. Here are some important guidelines you should consider:

Avoid heat sources, such as radiators, air ducts, and sunlight

Avoid television sets and other electronic equipment

Avoid noise sources such as a window by a street with heavy traffic

Avoid microwave ovens

Avoid excessive moisture, extremely low temperatures, dust, mechanical vibration, or shock

Avoid personal computers

Avoid other cordless telephones

Choose a central location

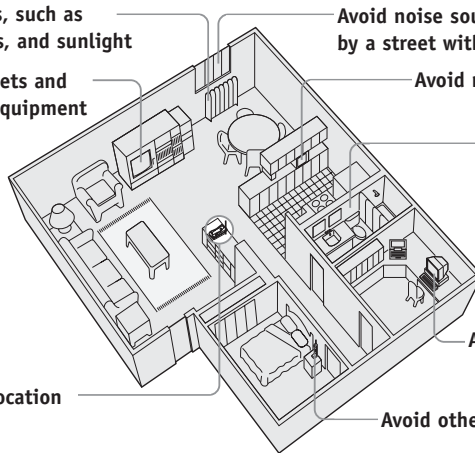

If your home has specially wired alarm equipment connected to the telephone line, be sure that installing the system does not disable your alarm equipment. If you have questions about what will disable your alarm equipment, contact your telephone company or a qualified installer.

B. Install the battery pack

Charge the battery pack for at least 15-20 hours before plugging the phone line into your base unit.

- 1) Press down on the battery cover release and slide the cover down until it comes off.
- 2) Connect the battery pack connector observing the correct polarity (black and red wires) to the jack inside the battery compartment.

Do not exert any force on this connection. It could cause damage to the battery or to the handset. The plastic connectors will fit together in only one way. Once you are certain that you have made a good connection, then insert the battery pack into the battery compartment. Do not pinch the wires.

- 3) Securely close the battery compartment cover by sliding it up until it snaps into place.
- 4) Place the handset in the base with the keypad facing forward.

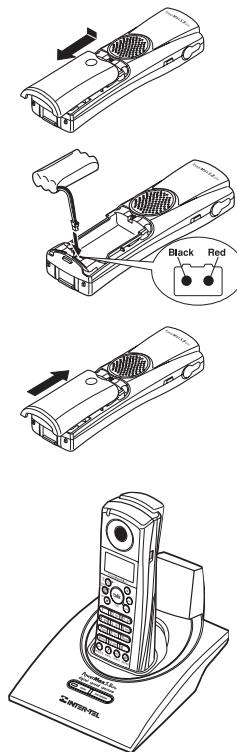

- Use only the Inter-Tel battery (BT-446) supplied with your phone. Replacement batteries are also available through Inside Sales.
- Recharge your phone on a regular basis by returning the handset to the base after each phone call.

Battery use time (per charge)

Fully charged (15-20 hours charge time)

- Up to 4 hours continuous use
- Up to 8 days when the handset is in the standby mode



When you charge the handset, Caller ID summary screen and the name of the handset, HS1 appears. For TRU5860-2, if HS2 appears, you are charging the handset No. 2.

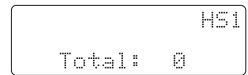

Low battery alert

When the battery pack is very low and needs to be charged, the phone is programmed to eliminate functions in order to save power. If the phone is in the standby mode, "Low Battery" appears on the LCD and none of the keys will operate. If the phone is in use, "Low Battery" appears and the handset beeps. Complete your conversation as quickly as possible and return the handset to the base unit for charging.

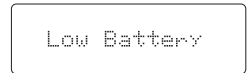

The last number dialed in the redial memory is retained for up to 2 minutes while you replace the battery pack.

Cleaning the battery charging contacts

To maintain a good charge, it is important to clean the charging contacts on both the handset and base unit once a month. Use a dry cloth or pencil eraser to clean. If the contacts become very dirty, using water only, dampen a cloth to clean the charging contacts. Then make sure to go back over the charging contacts with a dry cloth before returning the handset to the base to charge.

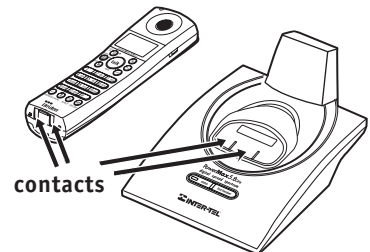

C. Connect the base unit

- 1) Connect the AC adapter to the **DC IN 9V** jack and to a standard 120V AC wall outlet.
- 2) Set the base and charger (for TRU5860-2 only) on a desk or tabletop, and place the handset in the base unit as shown.

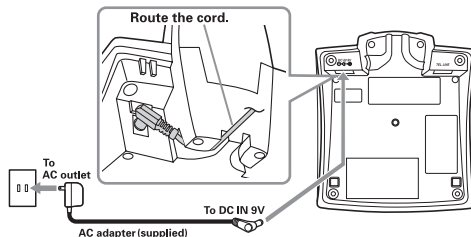

- 3) Make sure the **status** LED illuminates. If the LED does not illuminate, check to see that the AC adapter is plugged in and that the handset makes good contact with the base charging contacts.

- **Use only the supplied AD-312 AC adapter.**
Do not use any other AC adapter.
- Connect the AC adapter to a continuous power supply.
- Place the base unit close to the AC outlet so that you can unplug the AC adapter easily.

- 4) After installing the battery pack in the handset, charge your handset at least **15-20 hours before plugging into the phone line.**

- 5) Once the handset battery pack is fully charged, connect the telephone line cord to the **TEL LINE** jack and to a telephone outlet.

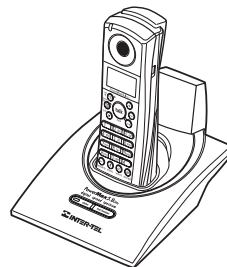

- t1p** If your telephone outlet isn't modular type, contact your telephone company for assistance.



Modular

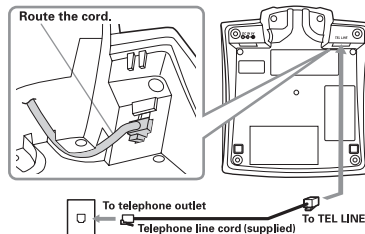

Place the power cord so that it does not create a trip hazard or where it could become chafed and create a fire or electrical hazard.



- If you are not sure of your dialing system, set the unit to tone dialing. Make a trial call. If the call connects, leave the setting as is, otherwise set the unit to pulse dialing.
- If your phone system requires pulse dialing and you need to send DTMF tones in certain situations during a call, you may “switch-over” to tone dialing. (Refer to “Tone Dialing Switch-over” on page 21.)

D. Choose the dialing mode

Most phone systems use tone dialing, which sends DTMF tones through the phone lines. However some phone systems still use pulse dialing such as in rural areas. The default setting is tone dialing. Depending on your dialing system, set the mode as follows:

- 1) When the phone is in the standby mode, press **menu/mute**.

```
▸ Ringer Volume
  Ringer Tones
  Distinct. Ring
```

- 2) Press **+** or **-** to move the pointer to “Dial Mode”.

```
  Distinct. Ring
  Caller ID Setup
  ▸ Dial Mode
```

- 3) Press **select/ch** and the display will show the current setting. (The initial setting is Tone.)

```
▸ Tone Dialing
  Pulse Dialing
```

- 4) Press **+** or **-** to change the selection.
- 5) Press **select/ch**, and you will hear a confirmation tone.
- 6) Press **end** to exit.

Terminology

Throughout this manual, terms such as Standby and Talk Mode are used. Below is the terminology explanation.

Standby Mode - The handset is not in use, is off the base, and **talk/flash** or **spkr** has not been pressed. A dial tone is not present.

Talk Mode - The handset is not in the base and **talk/flash** or **spkr** has been pressed enabling a dial tone. “T_{alk}” appears in the display.

Setting Caller ID Options

There are three Caller ID setup options available: AutoTalk, CIDCW (Caller ID on Call Waiting), and Area Code. See page 14 for Area Code setup instructions.

AutoTalk allows you to answer the phone without pressing *talk/flash* or *spkr*. If the phone rings when AutoTalk is On, simply remove the handset from the base and the phone automatically answers the call. Or if the handset is not in the base, press any number key, *X/ tone*, or *#* to answer the call. If you set AutoTalk to Off, you must press *talk/flash* or *spkr* to answer the call.

Caller ID on Call Waiting (CIDCW) performs the same as regular Caller ID on a call waiting number. CW Deluxe allows you to handle call waiting calls in seven different ways. (See page 36.)

You must subscribe to CIDCW from your phone company in order to use this feature.

The CW Deluxe is a separate service available through your phone company.

To change your Caller ID options:

- 1) When the phone is in the standby mode, press *menu/mute*.
- 2) Press + or - to move the pointer to "Caller ID Setup", then press *select/ch*.
- 3) Press + or - to choose "Auto Talk" or "CIDCW", then press *select/ch*.
- 4) Press + or - to change the selection.
AutoTalk: "Auto Talk On" or "Auto Talk Off"

CIDCW: "CIDCW On", "CW Deluxe On" or "CIDCW Off"

- 5) Press *select/ch* and you will hear a confirmation tone.
- 6) Press *end* to exit.

```

Ringer Volume
Ringer Tones
Distinct. Ring
  
```

```

Ringer Tones
Distinct. Ring
Ringer ID Setup
  
```

```

Auto Talk
CIDCW
Area Code
  
```

```

Auto Talk On
Auto Talk Off
  
```

```

CIDCW On
CW Deluxe On
CIDCW Off
  
```



- If your calling area requires 10-digit dialing, do not program this option.
- When the area code has already been stored in memory, the stored area code will be displayed. To change it, press **xfer/del** three times. Then enter the new area code. Or you can use **III /RocketDial/←** or **call id/→** to move the cursor and edit the area code.

Entering Your Area Code

If you enter a 3-digit area code number in the “Area Code” option, your local area code does not appear in Caller ID messages. For calls received from outside your local area code, you will see a full 10-digit number.

- 1) When the phone is in the standby mode, press **menu/mute**.
- 2) Press **+** or **-** to move the pointer to “Caller ID Setup”, then press **select/ch**.
- 3) Press **+** or **-** to move the pointer to “Area Code”, then press **select/ch**.
- 4) Use the number keypad (**0** to **9**) to enter a 3-digit area code.
- 5) Press **select/ch**, and you will hear a confirmation tone.
- 6) Press **end** to exit.

```
▸ Ringer Volume
  Ringer Tones
  Distinct. Ring
```

```
Ringer Tones
Distinct. Ring
▸ Caller ID Setup
```

```
Auto Talk
CIDCW
▸ Area Code
```

```
Area Code
■
```

Selecting a Language

Language option can be used to choose the language of your display. You can select English, French, or Spanish.

- 1) When the phone is in the standby mode, press **menu/mute**.

```
▸ Ringer Volume
  Ringer Tones
  Distinct. Ring
```

- 2) Press + or - to move the pointer to "Language", then press **select/ch**.

```
Caller ID Setup
Dial Mode
▸ Language
```

- 3) Press + or - to choose English, French (Français), or Spanish (Español).

```
▸ English
  Français
  Español
```

- 4) Press **select/ch**, and you will hear a confirmation tone.
- 5) Press **end** to exit.



- Refer to page 13 “Setting Caller ID Options” to turn the AutoTalk feature On if desired. Any key answer can be used only when AutoTalk is set to On.
- The handset microphone is located on the bottom of the handset (see “Controls and Functions” on page 5). Position yourself as near to the handset as possible and speak clearly.

Making and Receiving Calls

On the handset, you may also use the speakerphone while talking on your phone. Using the handset speakerphone is called “hands-free conversation”. This feature allows you to easily communicate while performing other tasks, such as cooking.  appears during hands-free conversation.

You can easily switch a call from normal conversation to “hands-free conversation”. To switch a call, press *spkr* during the call.

	From the Handset	
	Normal conversation	Hands-free conversation
To answer a call	Handset On the Base Pick up the handset (AutoTalk) or pick up the handset and press <i>talk/flash</i> . Handset Off the Base Press any number key, <i>X/tone</i> , or # (Any Key Answer), or press <i>talk/flash</i> .	Handset Off the Base Press <i>spkr</i> .
To make a call	Handset Off the Base 1) Press <i>talk/flash</i> . 2) Listen for the dial tone. 3) Dial the number. OR Dial the number, then press <i>talk/flash</i> .	Handset Off the Base 1) Press <i>spkr</i> . 2) Listen for the dial tone. 3) Dial the number. OR Dial the number, then press <i>spkr</i> .
	Note: If a call is not established, you will hear a beep and “Unavailable” will appear in the display.	
To hang up	Press <i>end</i> , or return the handset to the base (AutoStandby).	
To enter a pause within the dialing sequence	When you dial the number, press <i>redial/p</i> . “P” appears in the display, which represents a pause.	

Redialing a Call

The last three phone numbers dialed can be quickly redialed.

Redialing from Standby Mode

- 1) Press **redial/p**. The phone number that was last dialed appears on the display.
- 2) Press **redial/p** again. Each press of **redial/p** will display one of the last three numbers dialed.
- 3) Press **talk/flash** or **spkr**. The selected number is dialed.
- 4) To hang up, press **end**.



- If you have not pressed any key for 30 seconds, the phone returns to standby mode.
- If you press **end**, the operation is canceled and the phone will return to the standby mode.

Redialing from Talk Mode

- 1) Press **talk/flash** or **spkr**.
- 2) Press **redial/p**. The last number dialed will be displayed and redialed.
- 3) To hang up, press **end**.



When using the redial feature in talk mode, only the last number dialed will be displayed.

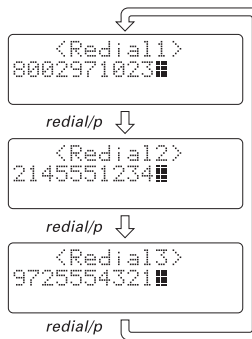

- If the number exceeds 32 digits, only the first 32 digits are retained in redial memory.
- If the redial memory is empty, you will hear a beep.



- If you select “Ringer Off”, “Ringer Off” appears in the display when you make or receive calls, or charge the handset.

Ringer Volume Setup

- 1) When the phone is in the standby mode, press **menu/mute**.
- 2) Press + or - to move the pointer to “Ringer Volume”.
- 3) Press **select/ch**.
- 4) Press + or - to move the pointer through the ringer settings (Ringer Off, Ringer Low, or Ringer High).
You will hear a ringer or melody at the selected volume.
- 5) Press **select/ch**, you will hear a confirmation tone.
- 6) Press **end** to exit.

```
Ringer Volume
Ringer Tones
Distinct. Ring
```

```
Ringer Off
Ringer Low
Ringer High
```

Ringer Mute (temporarily)

You can temporarily mute the ringer tone. When the handset is off the base and the phone is ringing, press **end**. The ringer tone will return to the previous setting starting with the next incoming call.

Ringer Tone Setting

- 1) When the phone is in the standby mode, press **menu/mute**.
- 2) Press + or - to move the pointer to “Ringer Tones”, then press **select/ch**.
You can choose from 6 ringers or 4 melodies:
 - Ringers [Flicker, Clatter, Leap Frog, Ping Ball, Reminder, Soft Alert]
 - Melodies [Beethoven9, For Elise (Elise), Merry Christmas (Merry-Xmas), Home Sweet Home (Hm Swt Hm)]
- 3) Press + or - to move the pointer. You will hear the ringer or the melody as you scroll through the options.
- 4) Press **select/ch** and you will hear a confirmation tone.
- 5) Press **end** to exit.

```
Ringer Volume
Ringer Tones
Distinct. Ring
```

```
Ringer Volume
Ringer Tones
Distinct. Ring
```

```
Flicker
Clatter
Leap Frog
```



- If you set the ringer to Off, the ringer tone will not sound.

Distinctive Ringer Setup

“Distinctive Ringer” allows you to preset memory locations with a designated ring tone. When an incoming call is received and the Caller ID information matches the information in one of the memory locations, the Distinctive Ring that has been stored for that particular caller will sound.

If you have set multiple memory locations with distinctive rings, switching the setting to “Distinctive Off” will result in no distinctive ringing. All incoming calls will have a normal ring tone. Switching to “Distinctive On” will activate all programmed distinctive ring memory locations.

- 1) When the phone is in the standby mode, press **menu/mute**.
- 2) Press **+** or **-** to move the pointer to “Distinct. Ring”, then press **select/ch**.
- 3) Press **+** or **-** to choose “Distinctive On” or “Distinctive Off”.
- 4) Press **select/ch**, and you will hear a confirmation tone.
- 5) Press **end** to exit.

```
Ringer Volume
Ringer Tones
Distinct. Ring
```

```
Ringer Volume
Ringer Tones
Distinct. Ring
```

```
Distinctive On
Distinctive Off
```



- See “Storing Phone Numbers, Names, Distinctive Rings, and Speed Dial” on page 23 for storing a Distinctive Ring in the Phonebook.

Adjusting the Earpiece and Handset Speaker Volume

You can select different volume levels for the handset earpiece and the handset speaker (Volume Low, Volume Medium, Volume High, and Volume Maximum). The volume can only be adjusted during a call. Press + or - to select the volume settings. When you hang up, the phone keeps the last volume setting selected.



If you press + in maximum volume level or - in lowest volume level, you will hear a beep.



- If you press **end** to cancel muting, the call is disconnected and the phone will return to standby mode.
- If you press **xfer/del** while muting, the muting is canceled.

Mute Microphone

You can temporarily turn Off the microphone so that the person you are talking with cannot hear you.

During a telephone call press and hold **menu/mute** to turn Off the microphone, and “Mute” appears on the display. Press **menu/mute** again to cancel muting.

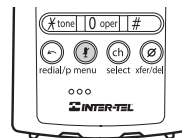

Tone Dialing Switch-over

Some telephone companies use equipment that requires pulse dialing (sometimes referred to as rotary dialing). If you need to enter tone dialing digits, you can switch-over to tone dialing during the call. For example, entering your bank account number after you have called your bank.

Initially make your call with the pulse dialing mode. Once your call connects, press **X/tone**. Enter the desired number. These digits will be sent as tone dialing. Once the call ends, the tone mode is canceled and pulse dialing mode resumes.

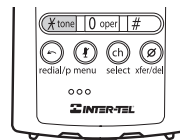

Traveling Out-of-Range

During a call, as you begin to move your handset too far from your base unit, noise increases. If you pass the range limits of the base unit, your call will terminate within 30 seconds. To avoid your call being terminated, quickly move your handset back in range.

Selecting a Different Channel

If you encounter interference while using your phone, you can manually change the phone's channel for clear operation. This function works only when the phone is in use.

Press **select/ch**. "Scanning" appears on the display, indicating the phone is changing to another channel. For more information on interference, refer to "Radio Interference" on page 44.



- The tone feature only applies when the dial mode is set to pulse.
- This special number can be stored in a memory location. This is referred to as Chain Dialing. (See page 31.)



- If the handset battery is completely drained, the handset will not beep when paging.



You must subscribe through your local telephone company to receive Call Waiting Service.

Find Handset

To locate the handset, press **find handset** on the base when the base is in the standby mode. The handset beeps for 60 seconds, and “Paging” appears on the handset display.

Paging is canceled when pressing any key on the handset or **find handset** on the base. Additionally, if you receive an incoming call, page is canceled.

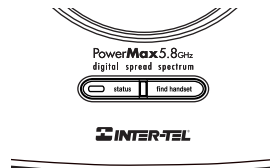

Flash and Call Waiting

If you have Call Waiting service and a call waiting tone sounds while you are on a call, press **talk/flash** to accept the waiting call. There is a short pause, then you will hear the new caller. To return to the original caller, press **talk/flash** again.



Voice Mail LED

The **voice mail** LED on the handset is designed to work with your voice mail service provided by your local telephone company. The LED flashes when you have new messages in your voice mail box.

You may need to occasionally reset the indicator if it remains On after you've retrieved your messages. To reset the indicator, when the phone is in the standby mode, press and hold **find handset** on the base until the paging sound stops (about 5 seconds).

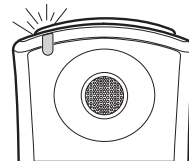

Phonebook

Phonebook allows you to dial a number using just a few key presses.

Your phone stores names/numbers in the phonebook memory location, and you can search names in alphabetical order. You have a total of 100 locations that can be used for the phonebook (including the Speed dials) and Caller ID messages.



- If any of the following occurs during a phonebook operation, the operation will be canceled.
 - Press **end**. The phone will return to the standby mode (or the call will be disconnected).
 - Press **talk/flash** or **spkr**.
 - Receive an incoming call, page, or transferring call (from the standby mode only).
 - Charge the handset
 - Receive a CIDCW (Caller ID on Call Waiting) (during a call only).
- The idle time is 30 seconds. If the handset remains idle for 30 seconds, the phone will return to the standby mode (or back to the call).

Storing Phone Numbers, Names, Distinctive Rings, and Speed Dial

- 1) When the phone is in the standby mode, press **[*] /RocketDial/ <**.
The handset displays the number of the phonebook locations used, and information on searching and storing phonebook locations.
 - (1st line) The number of the phonebook locations used
 - (2nd line) How to search (press the number keypad, + or -)
 - (3rd line) How to enter the storing operation (press **select/ch**)

```
Phonebook : 85
Search [A-Z/↑/↓]
Store [select]
```



- When the memory is full, you will hear a beep and “Memory Full” appears. You cannot store names and numbers.
- The pause key counts as one digit. Pressing **redial/p** more than once increases the length of pause between numbers.
- If you select a Speed dial location where a number is already stored, the new number will replace the old number, and the old number will be stored as a phonebook location.

2) Press **select/ch**, “Store/Edit Name” appears.

```
Store/Edit Name
█
```

- 3) Store the name (up to 16 characters) by using the number keypad.
- See the “Steps for entering names and special characters” (see page 27).
 - Use **call id/→** and **☐/RocketDial/←** to move the cursor to the desired location.
 - Use **xfer/del** to delete characters as needed.
 - Press and hold **xfer/del** to delete all the characters.

If a name is not required, go to step 4.

4) Press **select/ch** to store the name, “Store/Edit No.” appears.

```
Store/Edit No.
█
```

5) Press the number keypad to enter the phone number (up to 20 digits), press **select/ch** to store the number.

6) “Distinctive Ring” appears. Press **+** or **-** to move the pointer to one of the Distinctive Ring options, then press **select/ch**.

```
Distinctive Ring
█No Selectn
Flicker
```

 If you choose not to store a “Distinctive Ring”, simply select the “No Selectn” option.

7) “Speed Dial” appears. Press **+** or **-** to move the pointer to select the Speed dial location (10 locations: SPD1-SPD0).

```
Speed Dial
█No Selectn
SPD1:Uniden Cor
```

 If you choose not to store the name/number as a Speed Dial, simply select the “No Selectn” option.

8) Press **select/ch**. You will hear a confirmation tone and “Done!” appears on the display.

Steps for Entering Names and Special Characters

Refer to the letters on the number keys to select the desired characters. With each press of a number key (0-9), the displayed character appears in the following order: Upper case letters first, lower case letters next and finally the number corresponding to the key.

	Number of times key is pressed								
keys	1	2	3	4	5	6	7	8	9
1	i								
2abc	A	B	C	a	b	c	2		
3def	D	E	F	d	e	f	3		
4ghi	G	H	I	g	h	i	4		
5jkl	J	K	L	j	k	l	5		
6mno	M	N	O	m	n	o	6		
7pqrs	P	Q	R	S	p	q	r	s	7
8tuv	T	U	V	t	u	v	8		
9wxyz	W	X	Y	Z	w	x	y	z	9
0oper	*	#	-	&	()	(blank)	0	

If you make a mistake while entering a name

Use /RocketDial/← or call id/→ to move the cursor to the incorrect character.

Press *xfer/del* to erase the wrong character, then enter the correct character. To delete all characters, press and hold *xfer/del*.

For example, to enter **Inter-Tel**:

- 1) When the phone is in the standby mode, press **[[[/RocketDial/←**.
The handset displays the number of phonebook locations you have stored, and how to search and store the phonebook locations.
- 2) Press **select/ch**, "Store/Edit Name" appears.
- 3) Press **8** twice.
- 4) Press **6** five times.
- 5) Press **4** six times.
- 6) Press **3** four times, then press **call id/→** to move the cursor to the right.



If the next character uses the same number key, you must press **call id/→** to move the cursor over. Otherwise the next time you press the number key, it changes the character that was previously set.

- 7) Press **3** five times.
- 8) Press **6** five times.
- 9) When finished, press **select/ch**.

To continue to store the telephone number, proceed to step 5 on page 26.

Viewing the Phonebook

Your phone stores names/numbers in the phonebook memory locations, and you can search names in alphabetical order. You can view the phonebook during a call as well as when the phone is in the standby mode.

- 1) Press **[Phonebook] /RocketDial/←**.

If you press **[Phonebook] /RocketDial/←** during a call, the following screen appears.

```
Phonebook : 85
Search [A-Z/↑/↓]
Store [select]
```

```
Phonebook : 85
Search [A-Z/↑/↓]
```

- 2) Press **+** or **-**, or the number keypad to view the phonebook locations.

a) Alphabetical order

Ascending order: Press **-** to view locations. The location in the RocketDial appears first in the display. Each time **-** is pressed, phonebook locations appear in ascending order.

Descending order: Press **+** to view locations. A name starting with a number or a mark, or **<No Name>** appears first. Each time **+** is pressed, phonebook locations appear in descending order.

b) From a number key

Refer to the letters on the number keys to select the first letter of the desired name. Press a number key until any name with the same initial is displayed (See the table in “Steps for Entering Names and Special Characters” on page 27).

For example, to search for “Inter-Tel”, press **8** two times. Press **-** or **+** until the name is displayed. If you press **+** while the first name in “U” is displayed, a name starting with “T” will appear, or if you press **-** while the last name in “U” is displayed, a name starting with “V” will appear.

- 3) To finish the viewing operation, press **[Phonebook] /RocketDial/←** (if you view the phonebook during a call) or **end**.



“/SD” appears on the display when you review the RocketDial, and “/SPDr” appears when you review a Speed dial.

Making Calls Using the Phonebook

From Standby Mode

- 1) When the phone is in the standby mode, press **[*]/RocketDial/←**.
- 2) Press **+** or **-**, or the number keypad to view the phonebook locations (see “Viewing the Phonebook” on page 27).
- 3) Press **talk/flash** or **spkr**. The displayed number is dialed.
- 4) To hang up press **end**.

```
Phonebook : 85  
Search [A-Z/↑/↓]  
Store [select]
```

From Talk Mode

- 1) Press **talk/flash** or **spkr**.
- 2) Press **[*]/RocketDial/←**.
- 3) Press **+** or **-**, or the number keypad to view the phonebook locations (see “Viewing the Phonebook” on page 27).
- 4) Press **select/ch**. The number in the displayed phonebook location is dialed.
- 5) To hang up press **end**.

```
Phonebook : 85  
Search [A-Z/↑/↓]
```

Speed Dialing

If you select a speed dial memory location (10 locations: SPD1 - SPD0) when storing a phone number in the phonebook dial location, you can use the speed dialing feature. When the phone is in the standby mode, press and hold a number key (**0-9**) associated with the speed dial. The number stored in the speed dial appears, then press **talk/flash** or **spkr**. The phone number in the speed dial (SPD1 - SPD0) is dialed.

Editing or Erasing a Stored Name, Phone Number, Distinctive Ring, and Speed Dial

- 1) When the phone is in the standby mode, press **☰ /RocketDial/←**.
- 2) Press **+** or **-**, or the number keypad to view the phonebook locations (see “Viewing the Phonebook” on page 27).

```
Phonebook : 85
Search [A-Z/↑/↓]
Store [select]
```

Editing the Stored Data

- 1) When the phonebook location to be edited appears, press **select/ch**. “Store/Edit Name” appears.
- 2) Follow the steps 3 to 7 under “Storing Phone Numbers, Names, Distinctive Rings, and Speed Dial” on page 23 to complete the editing operation.
- 3) Press **select/ch**. You will hear a confirmation tone and “Done!” appears on the display.

```
Store/Edit Name
Uniden Core☰
```

Deleting the Stored Data

- 1) When the phonebook location to be deleted appears, press **xfer/del**. “Delete Memory?” appears.
- 2) Press **+** to move the pointer to “Yes”.
- 3) Press **select/ch** or **xfer/del**. You hear a confirmation tone. “Deleted!” appears in the display.

```
Delete Memory?
Yes
☰ No
```

```
Delete Memory?
☰ Yes
No
```

```
Deleted!
```



- Memory location for the RocketDial is independent from the memory location for the phonebook.

- If the RocketDial is empty, you will hear a beep.

RocketDial (One Touch Dialing)

You can store a number you dial often in the RocketDial. The rocket dialing allows you to dial a number with one key press.

Storing the RocketDial

- 1) When the phone is in the standby mode, press **[*]/RocketDial/←**.
- 2) Press **-** once to display the RocketDial menu, then press **select/ch**. Store the name, phone number, and distinctive ring by following the steps 3 to 6 under "Storing Phone Numbers, Names, Distinctive Rings and Speed Dial" on page 23.
- 3) You will hear a confirmation tone and "Done!" appears in the display.

Making calls with the RocketDial

When the phone is in the standby mode, press and hold **[*]/RocketDial/←**. The number in the rocket location is dialed.

Deleting the RocketDial

- 1) When the phone is in the standby mode, press **[*]/RocketDial/←**.
- 2) Press once **-** to display the RocketDial menu.
- 3) Press **xfer/del**.
- 4) Press **+** to move the pointer to "Yes".
- 5) Press **select/ch** or **xfer/del**. You will hear a confirmation tone. "Deleted!" appears in the display.

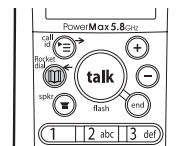

```
Phonebook : 85  
Search [A-Z/↑/↓]  
Store [select]
```

```
<Empty> /SD
```

```
- Connecting -  
8175551212
```

```
MOM AND DAD  
817-555-1212  
↑Flicker /SD
```

```
Delete Memory?  
Yes  
▶No
```

```
Delete Memory?  
▶Yes  
No
```

Chain Dialing

The memory locations in the handset are not limited to phone numbers. You can also store a group of numbers (up to 20 digits), that you need to enter once your call connects. This is referred to as Chain Dialing.

An example of this is a bank account number. Store the special number in the Phonebook location (refer to “Storing Phone Numbers, Names, Distinctive Rings and Speed Dial” on page 23). Once you have called your bank, and when you are prompted to enter the account number, press **[M] /RocketDial/←** and use **+** or **-** to select the number in the Phonebook location, then press **select/ch**.



- If you answer a call before the Caller ID message is received (Example: before the second ring), the Caller ID message will not appear.
- When the call is received via a telephone company that does not offer Caller ID service, the caller's phone number and name do not appear. (This includes some international calls.)
- When the call is via a private branch exchange (PBX), the caller's phone number and name may not appear.

Caller ID

You must subscribe to Caller ID service to use this feature.

When the telephone rings, the Caller ID feature allows you to view the caller's name and phone number on the display before you answer the phone. Additionally, you can dial the displayed number and store the information for memory dialing.

Make sure you have turned on the Caller ID/Call Waiting feature. (See page 13.)

Important:

Memory locations for Caller ID messages and Phonebook locations (including Speed Dials) are common, you can store up to 100 in total. A Caller ID message is not stored when you have stored 100 of the phonebook locations. The earliest Caller ID message is overwritten when you have stored 100 of the phonebook locations and Caller ID messages in total.



- If any of the following occurs during Caller ID operation, the operation will be canceled.
 - Press **end**. The phone will return to the standby mode (or the call will be disconnected).
 - Press **talk/flash** or **spkr.** (except for during hands-free conversation)
 - Receive an incoming call, page, or transferring call (from the standby mode only).
 - Receive a CIDCW (Caller ID on Call Waiting) (during a call only).
 - Charge the handset.
- The idle time is 30 seconds. If the handset remains idle for 30 seconds, the phone will return to the standby mode (or back to the call).

- 1) When the Caller ID message is received, the display shows the caller's phone number along with the date and time. The incoming call information is stored in the Caller ID record. If the Caller ID service includes the caller's name, the name will appear on the display. (up to 15 characters.)

The date and time received	12/12 12:30PM
Caller's name	Inter-Tel
Caller's phone number	480-961-9000

You may receive any one of the following messages:

- When invalid data is received "Incomplete Data"
- When a private name is received "Private Name"
- When a private number is received "Private Number"
- When an unknown name is received "Unknown Name"
- When an unknown number is received "Unknown Number"

- 2) When you pick up the phone, the display changes to "Talk". (AutoTalk feature is set to On.)

Viewing the Caller ID List

The Caller ID list stores information for incoming calls – even unanswered calls. You can store 100 of the Caller ID messages and Phonebook locations (including Speed Dials) in total. You can view the Caller ID list during a call or when the phone is in the standby mode.

- 1) Press **call id**/→.

The summary screen appears. The screen shows the number of new messages and the total number of messages.

Caller ID
New : 1
Total: 2

- 2) View the Caller ID messages by following these procedures.

From new to oldest:

- a. Press - to display the latest Caller ID message.
- b. Press - to see the previous message.

From oldest to new:

- a. Press + to display the earliest Caller ID message.
- b. Press + to see the next message.

In alphabetic order:

Press the number keypad (**2-9** and **0**) to display the Caller ID messages in alphabetical order. Refer to the letters on the number keys to select the desired letter.



Once you view the Caller ID list in alphabetical order, you cannot switch to the Caller ID display in historical order (from new to old or from old to new) unless you exit the operation.

- 3) To finish the viewing operation, press **call id**/→ (if you view the Caller ID list during a call) or **end**.



The number of calls from the same Caller ID appears next to the received time. Once you have reviewed the new message, the number will be cleared and disappears.



Once the Caller ID data has been deleted, the information cannot be retrieved.

Deleting Information from the Caller ID List

Deleting a Caller ID message

- 1) When the phone is in the standby mode, and while the incoming Caller ID information is displayed, press *xfer/del*.
"Delete Message?" appears.
- 2) Press + or - to choose "Yes" or "No".
- 3) Press *select/ch* or *xfer/del*.

```
Delete Message?  
▶ Yes  
No
```

When the pointer is at "Yes": You will hear a confirmation tone, and the Caller ID message is deleted. The next or previous Caller ID message is then displayed.

When the pointer is at "No": The display returns to the Caller ID message.

Deleting all Caller ID names/numbers

- 1) When the phone is in the standby mode, press *call id/→*.
- 2) Press *xfer/del*.
- 3) Press + or - to choose "Yes" or "No".
- 4) Press *select/ch* or *xfer/del*.

```
Caller ID  
New : 1  
Total: 2
```

```
Delete All?  
Yes  
▶ No
```

When the pointer is at "Yes": You will hear a confirmation tone, and all stored Caller ID messages are deleted.

When the pointer is at "No": The display returns to the summary screen.

Using the Caller ID Message List

Calling a party from the Caller ID list

From Standby mode

- 1) Press **call id**/→. The summary screen appears. The screen shows the number of new messages and the total number of messages.
- 2) Use the number keypad (**2-9** and **0**), **+**, or **-** to view the Caller ID message list.
- 3) Press **talk/flash** or **spkr**. The displayed phone number dials automatically.

```
Caller ID
New : 1
Total: 2
```

From Talk mode

- 1) Press **talk/flash**.
- 2) Press **call id**/→. The summary screen appears.
- 3) View the Caller ID message you want to dial.
- 4) Press **select/ch**. The displayed phone number will be dialed.

```
-Connecting-
8002971023
```

Long Distance calls and Area Code Setting/Cancellation

While the present Caller ID information is displayed, pressing **X/tone** will place or remove the prefix "1" in the display to set the call for a long distance call, or pressing **#** will set or cancel an area code. (See page 16.)

Storing Caller ID messages in the Phonebook/RocketDial

Messages shown in the Caller ID list can be stored in the phonebook. Using the incoming call information (i.e., Caller ID list), the phone number and name of the party on the Caller ID list can be stored in memory.

- 1) When the phone is in the standby mode, while the incoming Caller ID information is displayed, press **☐/RocketDial**/←.
- 2) Press **+** or **-** to choose "Store in PB?" (Phonebook locations) or "Store in SD?" (RocketDial location). To cancel Storing, select "Cancel".

```
12/12 12:30PM
Uniden Corp
800-297-1023
```

```
#Store in PB?
Store in SD?
Cancel
```

note

- You cannot make a call from the Caller ID list if your phone is connected to a private branch exchange (PBX).
- When a long distance call has been set, "1" appears in the display.
- If a call comes in via a telephone system that does not offer Caller ID service, no information is stored.

3) Press **select/ch**. You will hear a confirmation tone.



- You cannot store a Caller ID message in the phonebook if a phone number does not appear in the message.
- You cannot set the distinctive ring or speed dial in this step. If you would like to set these options, edit the stored data.
- Even if the memory locations are full, the message will be stored in the Phonebook, however, the message will be erased from the Caller ID List.
- If data is already stored in the RocketDial, the old data will be overwritten by the new data.



- To activate features, select "CID Deluxe On" in the Caller ID setup. See page 13.
- You can also answer a waiting call immediately by pressing **talk/flash**, the first caller will be placed on hold. To return to the original caller, press **talk/flash** again.

Call Waiting Deluxe Features

Your phone gives you new options for call waiting. At the touch of a button, you can place the caller on hold, send them to your voice mail service, or conference them into your current call. You may be required to subscribe to Call Waiting and Call Waiting Deluxe to use these features. Not all features are available in all areas. Check with your local telephone company for details.

- 1) When you receive a Call Waiting call, press **menu/mute** for a list of options.
- 2) Press + or -, or the number keypad (1-7) to select an option. For example:

```
1▶Ask to Hold
2 Tell Busy
3 Forward Call
```

press
-
4 times

```
3 Forward Call
4 Answer/Drop 1
5▶Conference
```

press
-
2 times

```
5 Conference
6 Drop First
7▶Drop Last
```

3) Press **select/ch**. A confirmation screen will appear.

Your phone is pre-programmed with seven call waiting options. You may select to ask the calling party to hold, send them a busy message, forward them to your voice mail, or answer and drop the first caller. You may also select to conference them into the current call or, at any time, choose to drop the first or drop the last caller.

Check with your local telephone company for a full list of options.

Changing the Digital Security Code

The digital security code is an identification code used to connect the handset and the base unit. Normally, setting the code is not necessary. In the rare situation that you suspect another cordless telephone is using the same security code, you can change the code. To change the digital security code, de-register the code, then register a different code.

De-register the Digital Security Code

- 1) Remove the handset from the base. In the standby mode, press and hold **xfer/del** and **end** for 10 seconds. You will hear a confirmation tone. "De-Register?" appears.
- 2) Press **+** to select "Yes", then **select/ch**. You will hear a confirmation tone, and "Deregistration Complete" appears.

note

- If you have not pressed any key for 30 seconds while in the de-registering operation, the phone returns to the standby mode.
- While in the de-registering operation, if you receive an incoming call, page, or transferring call, or charge the handset, or press **talk/flash**, **spkr** or **end**, the operation is canceled.



You will need to re-register the additional handset each time you change the digital security code of the original unit.

Register the Security Code

- 1) Unplug the AC adapter.
- 2) Press and hold **find handset** on the base while you plug in the AC Adapter, hold **find handset** until the **status** LED on the base flashes.
- 3) Press **talk/flash**. "Handset Registering" appears.

When the operation is finished "Registration Complete" appears and the **status** LED is turned Off. You will hear a confirmation tone and the phone returns to the standby mode.



- You must complete the registration operation within 30 seconds, or the phone returns to the standby mode.
- During the registration operation, you cannot receive an incoming call, page, or make a call.

Installing the Beltclip

To attach the beltclip

Insert the beltclip into the holes on each side of the handset. Press down until it clicks.

To remove the beltclip

Pull both sides of the beltclip to release the tabs from the holes.

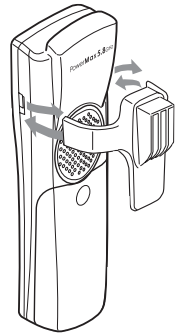

Headset Installation

Your phone may be used with an optional headset, the Inter-Tel HS910. To use this feature, insert the headset plug into the headset jack. Your phone is ready for hands-free conversations. (Headset may be purchased by calling the Inter-Tel Parts Department or visiting the web site. See page 9.)



Note on Power Sources

Battery replacement and handling

When the operating time becomes short, even after a battery is recharged, please replace the battery. With normal usage, your battery should last about one year.

Please contact your place of purchase or the Inter-Tel Parts Department for a replacement battery. (See page 9)

Warning

To avoid the risk of personal injury or property damage from fire or electrical shock, only use the Inter-Tel battery model and Inter-Tel adapter model specifically designated for this product.

Power Failure

During the period that the power is off, you will not be able to make or receive calls with the telephone.

Caution

- Use the specified Inter-Tel battery pack (BT-446).
- Do not remove the battery from the handset to charge it.
- Never throw the battery into a fire, disassemble it, or heat it.
- Do not remove or damage the battery casing.

Maintenance

When the handset or base unit becomes slightly dirty

Wipe with a soft, dry cloth.

When the handset or base unit becomes very dirty

Wipe with a soft cloth that has been dampened with diluted, neutral detergent. Dry with a dry cloth.

When the charging contacts become very dirty on both the handset and base unit

Using water only, dampen a cloth to clean the charging contacts. Then make sure to go back over the charging contacts with a dry cloth before returning the handset to the base unit to charge.

Caution

Do not use paint thinner, benzene, alcohol, or other chemical products. Doing so may discolor the surface of the telephone and damage the finish.

General Information

The phone complies with FCC Parts 15 and 68. Operating temperature: 0 °C to +50 °C (+32 °F to +122 °F)

AC Adapter Information

AC Adapter part number:	AD-312 for the base	AD-446 for the charger (TRU5860-2 only)
Input Voltage:	120V AC 60Hz	120V AC 60Hz
Output Voltage:	9V DC 350 mA	9V DC 210 mA

Battery Information

Battery part number:	BT-446
Capacity:	800 mAh, 3.6V
Battery use time (per charge) From fully charged	
Talk mode duration:	Up to 4 hours
Standby mode duration:	Up to 8 days



If the handset is left off of the base, the actual Talk mode duration will be reduced respective to the amount of time the handset is off the base.

Recharge your phone on a regular basis by returning the handset to the base after each phone call. When the operating time becomes short, even after the battery is recharged, please replace the battery. With normal usage, the battery should last about one year.

A replacement Inter-Tel adapter and battery may be purchase Inter-Tel accessories at your local Inter-Tel dealer or by contacting the Inter-Tel Parts Department (800) 554-3988. Hours are from 8:00 a.m. to 5:00 p.m. CST, Monday through Friday. We can also be reached on the web at www.inter-tel.com.

Specifications, features, and availability of optional accessories are all subject to change without prior notice.

Troubleshooting

If your phone is not performing to your expectations, please try these simple steps first.

Symptom	Suggestion
The status LED won't illuminate when the handset is placed in the base.	<ul style="list-style-type: none"> • Make sure the AC adapter is plugged into the base and wall outlet. • Make sure the handset is properly seated in the base. • Make sure the charging contacts on the handset and base are clean.
The audio sounds weak and/or scratchy.	<ul style="list-style-type: none"> • Move the handset and/or base to a different location away from metal objects or appliances and try again. • Press select/ch to help eliminate background noise. • Make sure that you are not too far from the base.
Can't make or receive calls.	<ul style="list-style-type: none"> • Check both ends of the base telephone line cord. • Make sure the AC adapter is plugged into the base and wall outlet. • Disconnect the AC adapter for a few minutes, then reconnect it. • Change the digital security code (See page 43). • Make sure that you are not too far from the base.
The handset doesn't ring or receive a page.	<ul style="list-style-type: none"> • The battery pack may be weak. Charge the battery in the base unit for 15-20 hours. • The handset may be too far away from the base unit. • Place the base unit away from appliances or metal objects. • Change the digital security code (See page 43).
Severe noise interference.	<ul style="list-style-type: none"> • Keep the handset away from microwave ovens, computers, remote control toys, wireless microphones, alarm systems, intercoms, room monitors, fluorescent lights, and electrical appliances. • Move to another location or turn off the source of interference.
The Caller ID does not display.	<ul style="list-style-type: none"> • The handset was picked up before the second ring. • The call was placed through a switchboard. • Call your local telephone company to verify your Caller ID service is current.
"Unavailable" message is displayed on the LCD screen of the handset.	<ul style="list-style-type: none"> • Make sure the other handset is not already in use. Both handsets cannot be in talk mode at the same time. • Place the handset for at least 5 seconds to re-register to the main base. • Make sure the handset is not too far from the main base when trying to use.
The handset doesn't communicate with the other handset.	<ul style="list-style-type: none"> • Change the digital security code (See page 43). • Make sure that you have registered the second handset (TXC580 only).
The second handset can't join the conversation.	<ul style="list-style-type: none"> • Only one handset at a time can talk with an outside caller. To allow a different handset to talk to the caller, transfer the call to the other handset.
If you still have a problem.	<ul style="list-style-type: none"> • Contact your local authorized Inter-Tel reseller.

Liquid Damage

Moisture and liquid can damage your cordless phone. In case of accidental submersion, please read the following steps.

Case	Action
If the handset or base is exposed to moisture or liquid, but only affects the exterior plastic housing.	Wipe off the liquid and use as normal.
If moisture or liquid has entered the plastic-housing (i.e. liquid can be heard in the phone or liquid has entered the handset battery compartment or vent openings on the base).	<p>Handset:</p> <ol style="list-style-type: none">1. Remove the battery cover and leave it off for ventilation.2. Remove the battery pack by disconnecting.3. Leave the battery cover off and the battery pack disconnected for at least 3 days.4. Once completely dry, reconnect the battery pack and the battery cover.5. Recharge the handset's battery pack for 20 hours in the base unit before using the phone. <p>Base:</p> <ol style="list-style-type: none">1. Disconnect the AC adapter from the base unit, cutting off electrical power.2. Disconnect the telephone cord from the base unit.3. Let dry for at least 3 days. <p>IMPORTANT: You must unplug the telephone line while recharging the battery pack to avoid charge interruption.</p> <p>CAUTION: DO NOT use a microwave oven to speed up the drying process. This will cause permanent damage to the handset, base and the microwave oven.</p> <p>After following these steps, if your cordless telephone does not work, please send to: Inter-Tel America Corporation Parts and Service Division 4700 Amon Carter Blvd. Ft. Worth, TX 76155 1-800-554-3988. Monday through Friday 8 a.m. to 5 p.m. CST</p>

Precautions!

Before you read anything else, please observe the following:

Warning!

Inter-Tel DOES NOT represent this unit to be waterproof. To reduce the risk of fire, electrical shock, or damage to the unit, DO NOT expose this unit to rain or moisture.

Rechargeable Nickel-Metal-Hydride Battery Warning

- This equipment contains a rechargeable Nickel-Metal-Hydride battery.
- Nickel is a chemical known to state of California to cause cancer.
- The rechargeable Nickel-Metal-Hydride battery contained in this equipment may explode if disposed of in a fire.
- Do not short-circuit the battery.
- Do not charge the rechargeable Nickel-Metal-Hydride battery used in this equipment in any charger other than the one designed to charge this battery as specified in the owner's manual. Using another charger may damage the battery or cause the battery to explode.

Rechargeable Nickel-Metal-Hydride Batteries Must Be Recycled or Disposed of Properly

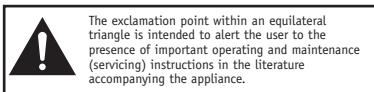

The exclamation point within an equilateral triangle is intended to alert the user to the presence of important operating and maintenance (servicing) instructions in the literature accompanying the appliance.

Inter-Tel works to reduce lead content in our PVC coated cords in our product and accessories.

WARNING:

The cords on this products and/or accessories contain lead, a chemical known to the State of California to cause birth defects or other reproductive harm. **Wash hands after handling.**

Important Safety Instructions

When using your telephone equipment, these basic safety precautions should always be followed to reduce the risk of fire, electrical shock, and injury to persons:

1. Read and understand all instructions.
2. Follow all warnings and instructions marked on the product.
3. Unplug this product from the wall outlet before cleaning. Use a dry cloth for cleaning without liquid or aerosol cleaners.
4. Do not use this product near water; for example, near a bathtub, wash bowl, kitchen sink or laundry tub, in a wet basement, or near a swimming pool.

5. Do not place this product on an unstable cart, stand, or table. The telephone may fall, causing serious damage to the unit.
 6. Slots and openings in the cabinet and the back or bottom are provided for ventilation. To protect the product from overheating, these openings must not be blocked or covered. This product should never be placed near or over a radiator or heat register. This product should not be placed in a built-in installation unless proper ventilation is provided.
 7. This product should be operated only from the type of power source indicated on the marking label. If you are not sure of the type of power supply to your home, consult your dealer or local power company.
 8. Do not allow anything to rest on the power cord. Do not locate this product where the cord will be damaged by persons walking on it.
 9. Do not overload wall outlets and extension cords, as this can result in the risk of fire or electrical shock.
 10. Never push objects of any kind into this product through cabinet slots, as they may touch dangerous voltage points or short out parts that could result in a risk of fire or electric shock. Never spill liquid of any kind on the product.
 11. To reduce the risk of electric shock, do not disassemble this product. Take it to qualified service personnel when service or repair work is required. Opening or removing covers may expose you to dangerous voltages or other risks. Incorrect reassembly can cause electric shock when the appliance is subsequently used.
 12. Unplug this product from the wall outlet and refer servicing to qualified service personnel under the following conditions:
 - A. When the power supply cord is damaged or frayed.
 - B. If liquid has been spilled into the product.
 - C. If the product has been exposed to rain or water.
 - D. If the product does not operate normally when following the operating instructions. (Adjust only those controls that are covered by the operating instructions. Improper adjustment of other controls may result in damage and will often require extensive repair work by a qualified technician.)
 - E. If the product has been dropped or the cabinet has been damaged.
 - F. If the product exhibits a distinct change in performance.
 13. Do not use the telephone to report a gas leak in the vicinity of the leak.
3. Do not open or mutilate the battery pack. Released electrolyte is corrosive and may cause damage to the eyes or skin. It may be toxic if swallowed.
 4. Exercise care in handling the battery in order not to short the battery with conducting materials such as rings, bracelets, and keys. The battery or conductor may overheat and cause burns.
 5. Charge the battery pack provided with or identified for use with this product only in accordance with the instructions and limitations specified in the owner's manual provided for this product.
 6. Observe proper polarity orientation between the battery pack and battery charger.

SAVE THESE INSTRUCTIONS!

Important Electrical Considerations

Unplug all electrical appliances when you know an electrical storm is approaching. Lightning can pass through your household wiring and damage any device connected to it. This phone is no exception.

The FCC Wants You To Know

Changes or modifications to this product not expressly approved by Inter-Tel, or operation of this product in any way other than as detailed by the owner's manual, could void your authority to operate this product. Your telephone complies with Part 68 of FCC Rules. You must, upon request, provide the FCC registration number and the REN to your telephone company. Both numbers are on the base unit.

NOTE: You must not connect your phone to:

- coin-operated systems
- most electronic key telephone systems

The FCC has established criteria for the amount of radio frequency energy various products may produce depending on their intended usage. This product has been tested and found to comply with the FCC exposure criteria. The base unit and the base antenna was designed to be installed so that it is not in contact with any person during operations.

Range

Your new phone is designed to achieve the maximum possible range by transmitting and receiving according to the highest specifications set forth by the FCC. We have rated this phone to operate at a maximum distance with the qualification that the range depends upon the environment in which the telephone is used. Many factors limit range, and it would be impossible to include all the variables in our rating. The Maximum Range rating of this phone is meant to be used as a means of comparison against other range claims.

Additional Battery Safety Precautions

Caution! To reduce the risk of fire or injury to persons by the battery, read and follow these instructions:

1. Use only the Inter-Tel battery pack specified in the owner's manual.
2. Do not dispose of the battery pack in a fire. The cell may explode. Check the Nickel Metal Hydride battery disposal package insert for disposal instructions.

Telephone Line Problems

The FCC has granted the telephone company the right to disconnect service in the event that your phone causes problems on the telephone line. Also, the telephone company may make changes in facilities and services which may affect the operation of your unit. However, your telephone company must give adequate notice in writing prior to such actions to allow you time for making necessary arrangements to continue uninterrupted service.

If you are having trouble with your telephone service, you must first disconnect your phone to determine if it is the cause of your problem. If you determine that it is the cause, you must leave it disconnected until the trouble has been corrected.

Radio Interference

Radio interference may occasionally cause buzzing and humming in your cordless handset, or clicking noises in the base. This interference is caused by external sources such as TV, refrigerator, vacuum cleaner, fluorescent lighting, or electrical storm. Your unit is NOT DEFECTIVE. If these noises continue and are too distracting, please check around your home to see what appliances may be causing the problem. In addition, we recommend that the base not be plugged into a circuit that also powers a major appliance because of the potential for interference. Be certain that the antenna on the unit is fully extended when needed.

In the unlikely event that you consistently hear other voices or distracting transmissions on your phone, you may be receiving radio signals from another cordless telephone or other source of interference. If you cannot eliminate this type of interference, you need to change to a different channel.

Finally, it should be noted that some cordless telephones operate at frequencies that may cause interference to nearby TVs and VCRs. To minimize or prevent such interference, the base of the cordless telephone should not be placed near or on top of a TV or VCR. If interference is experienced, moving the cordless telephone farther away from the TV or VCR will often reduce or eliminate the interference.

More than One Cordless Telephone

If you want to use more than one cordless telephone in your home, they must operate on different channels. Press the channel key to select a channel that provides the clearest communication.

Cordless Telephone Privacy

Cordless telephones are radio devices. Communications between the handset and base of your cordless telephone are accomplished by means of radio waves which are broadcast over the open airways. Because of the inherent physical properties of radio waves, your communications can be received by radio receiving devices other than your own cordless telephone unit. Consequently, any communications using your cordless telephone may not be private.

Installation Considerations

Selecting a Location

Before choosing a location for your new phone, there are some important guidelines you should consider:

- The location should be close to both a phone jack and continuous power outlet. (A continuous power outlet is an AC outlet which does not have a switch to interrupt its power.)
- Keep the base and handset away from sources of electrical noise such as motors or fluorescent lighting.
- The base can be placed on a desk or tabletop or mounted on a standard telephone wall plate.
- You should charge your new phone for 15-20 hours before completing the installation or using the handset.

Telephone Line Outlets

There are two types of phone outlets:

Modular Jack

Most phone equipment available now uses modular jacks. Phone cords are fitted with a molded plastic connector which plugs into this type of jack. If you do not have modular phone jacks, contact your local telephone company for information about their installation.

Hardwired Jack

Some equipment is wired directly to a phone jack, and these types of installations require a modular jack converter. This type of installation is not difficult; however, you should contact your Inter-Tel telephone dealer or a telephone supply store for advice about the proper adapter or converter for your particular situation.

Connecting the Telephone Cords

Consider these safety guidelines before connecting the telephone cords:

Caution!

- *Never install telephone wiring during a lightning storm.*
- *Never touch uninsulated telephone wires or terminals unless the telephone line has been disconnected.*
- *Use caution when installing or modifying telephone lines.*

Applying Power to the Base

This phone requires an AC outlet, without a switch to interrupt power, and the included AC adapter. To relieve strain on the DC plug when the phone is placed on a desk or table, wrap the power cord around the strain relief notch on the bottom of the base.

NOTE: Place the power cord so that it does not create a trip hazard, or where it could become chafed and create a fire or other electrical hazards.

One Year Limited Warranty

Important: Evidence of original purchase is required for warranty service.

WARRANTOR: INTER-TEL, INC.

ELEMENTS OF WARRANTY: Inter-Tel warrants, for one year, to the original retail owner, this Inter-Tel Product to be free from defects in materials and craftsmanship with only the limitations or exclusions set out below.

WARRANTY DURATION: This warranty to the original user shall terminate and be of no further effect 12 months after the date of original retail sale. The warranty is invalid if the Product is (A) damaged or not maintained as reasonable or necessary, (B) modified, altered, or used as part of any conversion kits, subassemblies, or any configurations not sold by Inter-Tel, (C) improperly installed, (D) serviced or repaired by someone other than an authorized Inter-Tel service center for a defect or malfunction covered by this warranty, (E) used in any conjunction with equipment or parts or as part of any system not manufactured by Inter-Tel, or (F) installed or programmed by anyone other than as detailed by the owner's manual for this product.

STATEMENT OF REMEDY: In the event that the product does not conform to this warranty at any time while this warranty is in effect, warrantior will either, at its option, repair or replace the defective unit and return it to you without charge for parts, service, or any other cost (except shipping and handling) incurred by warrantior or its representatives in connection with the performance of this warranty. Warrantior, at its option, may replace the unit with a new or refurbished unit. THE LIMITED WARRANTY SET FORTH ABOVE IS THE SOLE AND ENTIRE WARRANTY PERTAINING TO THE PRODUCT AND IS IN LIEU OF AND EXCLUDES ALL OTHER WARRANTIES OF ANY NATURE WHATSOEVER, WHETHER EXPRESS, IMPLIED OR ARISING BY OPERATION OF LAW, INCLUDING, BUT NOT LIMITED TO ANY IMPLIED WARRANTIES OF MERCHANTABILITY OR FITNESS FOR A PARTICULAR PURPOSE. THIS WARRANTY DOES NOT COVER OR PROVIDE FOR THE REIMBURSEMENT OR PAYMENT OF INCIDENTAL OR CONSEQUENTIAL DAMAGES. Some states do not allow this exclusion or limitation of incidental or consequential damages so the above limitation or exclusion may not apply to you.

LEGAL REMEDIES: This warranty gives you specific legal rights, and you may also have other rights which vary from state to state. This warranty is void outside the United States of America and Canada.

PROCEDURE FOR OBTAINING PERFORMANCE OF WARRANTY: If, after following the instructions in the owner's manual you are certain that the Product is defective, contact your local authorized Inter-Tel reseller.

Index

0 - 9

10 ring options18

A

Area Code14

AutoTalk13

B

Battery pack

 Preparing and charging9

 Replacement and handling39

Beltclip38

C

Caller ID32

 Caller ID service32

 Calling.....35

 Call Waiting13, 36

 Deleting34

 Setting13

 Storing35

 Using35

 Viewing33

Chain dialing31

Channel21

D

Deluxe Call Waiting features36

Dialing mode12

Digital security code7, 37

Distinctive Ringer19

E, F, G, H

Earpiece volume20

General information40

Hands-free conversation16

Headset installation.....38

I, J, K, L

Important safety instructions43

Language15

Liquid damage42

M, N, O

Maintenance39

Making a call16

Mute20

One touch dialing30

P, Q

Phonebook23

 Editing29

 Erasing29

Making calls28

 Storing23

 Viewing27

Precautions43

R

Receiving a call16

Redialing a call.....16

Ringer volume.....18

RocketDial30

S

Setting up8

 Base unit.....11

 Handset9

Speed dialing28

T, U, V, W, X, Y, Z

Troubleshooting41

Voice Mail LED22

Warranty44



Part #935.0306
1203

Copyright December, 2003, Inter-Tel, Incorporated. All products and services mentioned are the trademarks, service marks, registered marks or registered service marks of their respective owners.

Inter-Tel® is a registered trademark of Inter-Tel, Incorporated.
PowerMax™ is a trademark of Uniden America Corporation.