

6390 Analog Phone

A Phone Cord and Power Connections

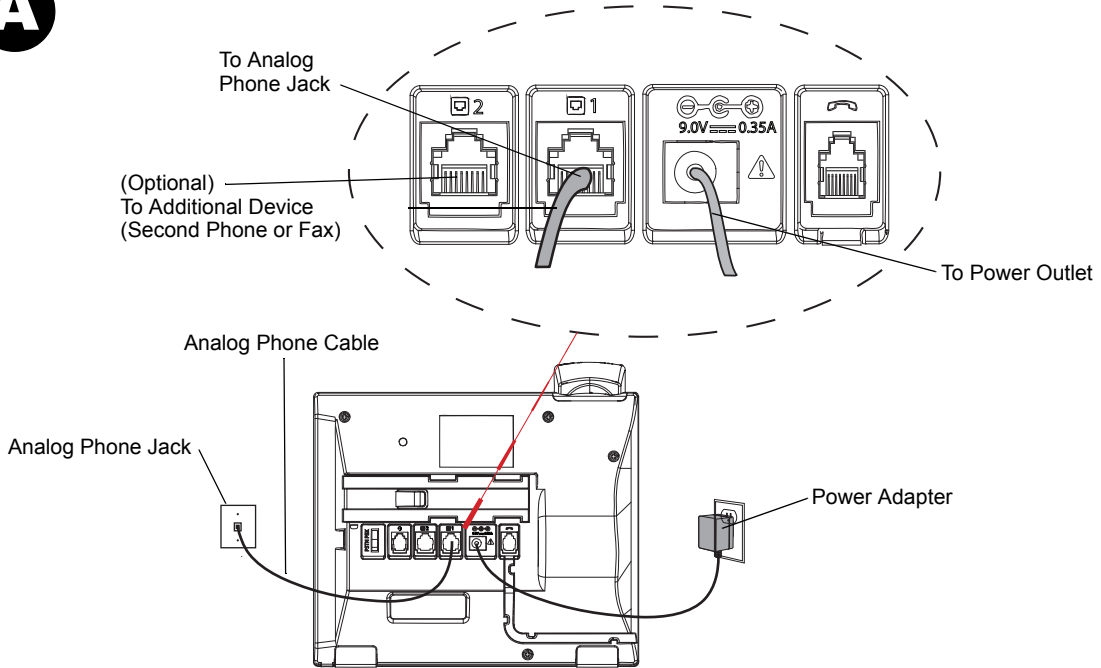

B Handset and Headset Connections

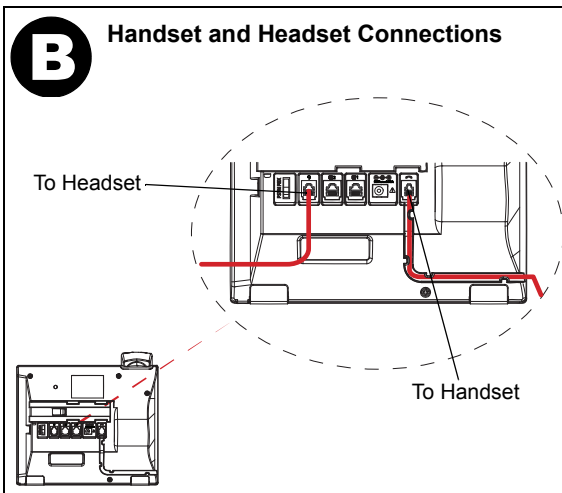

C Stand Attachment

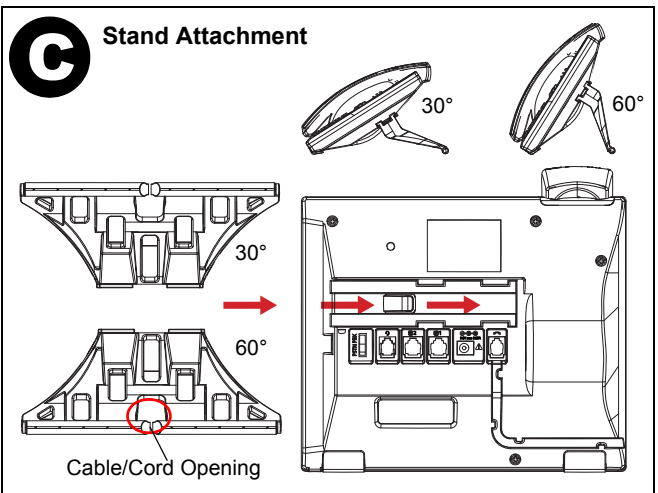

Important Safety Instructions and Precautions

WARNING: THE SOCKET OUTLET SHALL BE LOCATED NEAR THE EQUIPMENT AND SHALL BE EASILY ACCESSIBLE BY THE USER.

WARNING: USE MITEL APPROVED POWER ADAPTER PART NUMBER 50006811.

WARNING: USE ONLY THE HANDSET PROVIDED WITH YOUR PHONE. USE OF ANY OTHER HANDSET WITH YOUR PHONE MAY HAVE THE POTENTIAL TO CAUSE HEARING LOSS IN THE EVENT OF A LIGHTNING STRIKE ON THE OUTSIDE PLANT WIRING. THIS PRODUCT'S HANDSET EARCAP REGION IS SLIGHTLY MAGNETIC AND MAY PICK UP SMALL METALLIC OBJECTS, SUCH AS 26/6 GAUGE STAPLES. PLEASE CHECK THE EARCAP REGION FOR METALLIC OBJECTS BEFORE USE.

INSTALLATION

To avoid electrical shock hazard to personnel or equipment damage observe the following precautions when installing telephone equipment:

1. Never install telephone wiring during a lightning storm.
2. Never install telephone jacks in wet locations unless the jack is specifically designed for wet locations.
3. Never touch uninsulated telephone wires or terminals unless the telephone line has been disconnected at the network interface.

USE

When using your telephone equipment, basic safety precautions should always be followed to reduce risk of fire, electric shock and injury to persons, including the following:

1. Read and understand all instructions.
2. Follow the instructions marked on the product.
3. Unplug this product from the wall outlet before cleaning. Do not use liquid cleaners or aerosol cleaners. Use a damp cloth for cleaning.
4. Do not use this product near water, for example, near a bath tub, wash bowl, kitchen sink, or laundry tub, in a wet basement, or near a swimming pool.
5. Do not place this product on an unstable cart, stand or table. The product may fall, causing serious damage to the product.
6. This product should never be placed near or over a radiator or heat register. This product should not be placed in a built-in installation unless proper ventilation is provided.
7. Do not allow anything to rest on the power cord. Do not locate this product where the cord will be abused by persons walking on it.
8. Do not overload wall outlets and extension cords as this can result in the risk of fire or electric shock.
9. Never spill liquid of any kind on the product.
10. To reduce the risk of electric shock do not disassemble this product, but have it sent to a qualified service person when some service or repair work is required.

11. Unplug this product from the wall outlet and refer servicing to qualified service personnel under the following conditions:
 - a) When the power supply cord or plug is damaged or frayed.
 - b) If the product has been exposed to rain, water or liquid has been spilled on the product, disconnect and allow the product to dry out to see if it still operates; but do not open up the product.
 - c) If the product housing has been damaged.
 - d) If the product exhibits a distinct change in performance.
12. Avoid using a telephone during an electrical storm. There may be a risk of electric shock from lightning.
13. Do not use the telephone to report a gas leak in the vicinity of the leak.
14. **CAUTION:** To eliminate the possibility of accidental damage to cords, plugs, jacks, and the telephone, do not use sharp instruments during the assembly procedures.
15. **WARNING:** DO NOT INSERT THE PLUG AT THE FREE END OF THE HANDSET CORD DIRECTLY INTO A WALL OR BASEBOARD JACK. SUCH MISUSE CAN RESULT IN UNSAFE SOUND LEVELS OR POSSIBLE DAMAGE TO THE HANDSET.
16. Save these instructions.

MAINTENANCE AND REPAIR

There are no user serviceable parts inside the phones. For repairs, return the phone to an authorized Mitel dealer.

These notices may appear on the product or in the technical documentation:

DANGER	Danger indicates an imminently hazardous situation which, if not avoided, will result in death or serious injury.
WARNING	Warning indicates a potentially hazardous situation which, if not avoided, could result in death or serious injury.
CAUTION	Caution indicates a potentially hazardous situation which, if not avoided, may result in minor or moderate injury and/or damage to the equipment or property.

This symbol may appear on the product:

	The exclamation point within an equilateral triangle indicates that important operating and maintenance (servicing) instructions are included in the literature accompanying the product.
---	---

Description

Affordable and easy to use, the 6390 puts information and easy access to features right at your fingertips. While it is as affordable as many other telephones, the 6390 is far from ordinary. When it comes to making calls, the 6390's modern design and large display screen make a world of difference. Save up to 200 numbers in your Directory for fast, simple dialing. Place calls without lifting the receiver. Subscribe to network services like Call Display and Visual Call Waiting, and you will see the caller's name and number before you answer. With six "softkeys" that provide different options based on activity, the 6390 provides step-by-step instructions and menus for ease of use. You will never have to flip through pages of information to use the features. The 6390 is a telephone that offers flawless performance in any environment.

Phone Features



- Large 8-line 3.5" backlit display.
- 6 programmable softkeys (4 pages of softkeys for a total of 20 functions).
- Press-and-hold memory key configuration feature.
- 200-name and number Directory.
- 100-name and number Callers List.
- 15-name and number Redial List.
- English/French/Spanish language display prompts.
- Enhanced speakerphone for handsfree calls.
- Analog headset support.
- AC power adapter (included).

Supporting Documentation

To access phone and system-specific documentation:

1. In your browser, go to www.mitel.com.
2. Click **Product Manuals** under the **Support** section
3. Select **PDF Guides and Online Help** under the **End User Documents** drop-down menu.
4. In the left-hand menu, navigate to **Analog Phones**.

Phone Cord and Power Connections (See Figure A)

1. Insert the analog phone cable into the cable jack on the back of the telephone marked  1 until it clicks into place.
2. Insert the power adapter cord into the power jack on the back of the telephone marked .
3. Connect the other end of the analog phone cable to the analog phone jack on the wall.
4. Plug the power adapter into a power outlet (surge protector or power bar is recommended).

(Optional) Additional Device Connection

The 6390 has a secondary cable jack that enables an additional device (such as a second phone or fax machine) to share the telephone network connection.

1. Insert an analog cable into the cable jack on the back of the telephone marked  2 until it clicks into place.
2. Connect the other end of the analog cable into the cable jack of the additional device.

Handset and Headset Connections (See Figure B)

Connecting a Handset

1. Turn the phone over and locate the handset jack marked .
2. Insert one end of handset cord into the handset jack until it clicks into place.
3. Route the handset cord through the available grooves.
4. Attach the handset to the other end of the handset cord.

Connecting a Headset (Not Included)

1. Turn the phone over and locate the headset jack marked .
2. Insert the headset cord into the jack until it clicks into place.

Desk Installation (See Figure C)

For desk installation of the 6390 analog phone a reversible stand is included that attaches to the back of the phone above the various jacks. Two viewing angles (30° low angle and 60° high angle) are available allowing users to personalize their phone viewing preference.

1. Locate the stand insertion area on the back of the phone (above the various jacks).
2. Carefully insert the stand into the insertion area and slide the stand towards the right until it snaps in place.

NOTE: The orientation of the stand determines the viewing angle. If the bottom of the stand is installed facing the top of the phone the viewing angle will be 30°. If the bottom of the stand is installed facing the bottom of the phone the viewing angle will be 60°.

3. Route the analog phone cable and power cord through the opening of the stand (located on the bottom center of the stand.)

NOTE: This product is designed for indoor use only and for ambient temperatures from 0° C (32° F) to 40° C (104° F).

Wall Installation

The 6390 analog phone can be mounted to a wall using the 6300 Series Wall Mount Kit (optional accessory). The 6300 Series Wall Mount Kit is designed to be used with all 6300 Series analog phones allowing you to easily and securely mount your phone in one of two ways:

- Directly to the wall.
- On top of an existing telco wall plate.

NOTE: See the *6300 Series Wall Mount Kit Installation Guide* for additional product and installation details.

Notice to Canadian Customers

NOTICE: This product meets the applicable Industry Canada technical specifications. The Ringer Equivalence Number (REN) of the 6390 is 0.8A.

The Ringer Equivalence Number (REN) indicates the maximum number of devices allowed to be connected to a telephone interface. The termination of an interface may consist of any combination of devices subject only to the requirement that the sum of the RENs of all the devices not exceed five.

CAN ICES-3 (B)/NMB-3(B)

Notice to U.S. Customers

NOTICES

- This equipment complies with Part 68 of the FCC rules and the requirements adopted by the ACTA. On the base of this equipment is a label that contains, among other information, a product identifier in the format US:AAAEQ##TXXXX. If requested, this number must be provided to the telephone company.
- A plug and jack used to connect this equipment to the premises wiring and telephone network must comply with the applicable FCC Part 68 rules and requirements adopted by the ACTA. A compliant telephone cord and modular plug is provided with this product. It is designed to be connected to a compatible modular jack that is also compliant. See installation instructions for details.
- Use only an FCC compliant Universal Service Order Code (USOC) network interface jack. USOC RJ11C (surface or flush-mounted jack) or USOC RJ11W (wall-mounted jack).
- If this equipment causes harm to the telephone network, the telephone company will notify you in advance that temporary discontinuance of service may be required. But if advance notice isn't practical, the telephone company will notify the customer as soon as possible. Also, you will be advised of your right to file a complaint with the FCC if you believe it is necessary.
- The telephone company may make changes in its facilities, equipment, operations or procedures that could affect the operation of the equipment. If this happens the telephone company will provide advance notice in order for you to make necessary modifications to maintain uninterrupted service.
- If trouble is experienced with this equipment, for repair or warranty information, please call 1-800-574-1611. If the equipment is causing harm to the telephone network, the telephone company may request that you disconnect the equipment until the problem is resolved.
- Connection to party line service is subject to state tariffs. Contact the state public utility commission, public service commission or corporation commission for information.
- If your home has specially wired alarm equipment connected to the telephone line, ensure the installation of this equipment does not disable your alarm equipment. If you have questions about what will disable alarm equipment, consult your telephone company or a qualified installer.
- Do not attempt to repair this equipment. If you experience trouble, call 1-800-574-1611 for warranty and repair information.

RINGER EQUIVALENCE NUMBER

The REN is used to determine the number of devices that may be connected to a telephone line. Excessive RENs on a telephone line may result in the devices not ringing in response to an incoming call. In most but not all areas, the sum of RENs should not exceed five (5.0). To be certain of the number of devices that may be connected to a line, as determined by the total RENs, contact the local telephone company. For products approved after July 23, 2001, the REN for this product is part of the product identifier that has the format US:AAAEQ##TXXXX. The digits represented by ## are the REN without a decimal point (e.g. 03 is a REN of 0.3).

HEARING AIDS

This equipment is hearing aid compatible.

PROGRAMMING EMERGENCY NUMBERS

When programming emergency numbers and/or making test calls to emergency numbers:

1. Remain on the line and briefly explain to the dispatcher the reason for the call.
2. Perform tests during off-peak hours such as early morning or late evenings.

NOTE: This equipment has been tested and found to comply with the limits for a Class B digital device, pursuant to Part 15 of the FCC Rules. These limits are designed to provide reasonable protection against harmful interference in a residential installation. This equipment generates, uses and can radiate radio frequency energy and, if not installed and used in accordance with the instructions, may cause harmful interference to radio communications. However, there is no guarantee that interference will not occur in a particular installation. If this equipment does cause harmful interference to radio or television reception, which can be determined by turning the equipment off and on, the user is encouraged to try to correct the interference by one or more of the following measures:

- Reorient or relocate the receiving antenna.
- Increase the separation between the equipment and receiver.
- Connect the equipment into an outlet on a circuit different from that to which the receiver is connected.
- Consult the dealer or an experienced radio/TV technician for help.

NOTE: Changes or modifications not expressly approved by the party responsible for compliance could void the user's authority to operate the equipment.

Précautions et consignes importantes en matière de sécurité (Canada)

AVERTISSEMENT : LA PRISE DE SORTIE DOIT ÊTRE INSTALLÉE PRÈS DU MATÉRIEL ET FACILEMENT ACCESSIBLE PAR L'USAGER.

AVERTISSEMENT : UTILISEZ L'ADAPTATEUR C.A PORTANT LE NUMÉRO DE PIÈCE 50006811.

AVERTISSEMENT : LE COMBINÉ FOURNI AVEC LES TÉLÉPHONES N'EST PAS CERTIFIÉ POUR UNE UTILISATION AVEC D'AUTRES TÉLÉPHONES. L'UTILISATION DE CE COMBINÉ AVEC TOUT AUTRE TÉLÉPHONE RISQUE DE CAUSER UNE PERTE AUDITIVE S'IL Y A DÉCHARGE ÉLECTRIQUE AU CÂBLAGE EXTÉRIEUR. LA PARTIE DE L'ÉCOUTEUR DU COMBINÉ EST LÉGÈREMENT MAGNÉTIQUE ET PEUT RAMASSER DE PETITS OBJETS MÉTALLIQUES, TELS QUE LES AGRAFES DE CALIBRE 26/6. S'IL VOUS PLAÎT VÉRIFIER LA RÉGION DU COMBINÉ POUR LES OBJETS MÉTALLIQUES AVANT DE L'UTILISER.

INSTALLATION

Pour éviter qu'un employé ne prenne un choc électrique ou que le matériel ne soit endommagé, prenez les précautions mentionnées ci-après lorsque vous installez du matériel téléphonique.

1. N'effectuez jamais le câblage pendant un orage électrique.
2. N'installez jamais les prises téléphoniques dans un emplacement humide à moins que la prise soit spécifiquement conçue pour les endroits humides.
3. Ne touchez jamais à un cordon téléphonique non isolé ou à un terminal à moins que la ligne téléphonique ait été déconnectée de l'interface réseau.

UTILISATION

Pour éviter les risques d'incendie, de choc électrique et de blessure, prenez les précautions mentionnées ci-après lorsque vous utilisez du matériel téléphonique.

1. Lisez les directives et assurez-vous de bien les comprendre.
2. Respectez les avertissements et les directives figurant sur le produit.
3. Débranchez le produit des prises murales et téléphoniques avant de le nettoyer. N'utilisez pas de détersifs liquides ou en aérosol. Nettoyez-le avec un linge humide.
4. N'utilisez pas le produit près de l'eau, que ce soit près d'un bain, d'un lavabo, d'un évier de cuisine, d'un bac à laver, d'une piscine ou dans un sous-sol humide.
5. Évitez de placer ce produit sur un chariot, un support ou une table instables. Il pourrait tomber et subir de graves dommages.
6. Ne placez jamais ce produit près d'un radiateur ou d'une bouche de chaleur ou sur ceux-ci. Ce produit ne doit pas être intégré à un appareil ou à un meuble à moins qu'une ventilation appropriée ne soit prévue.
7. Ne placez rien sur le cordon d'alimentation. Évitez de placer le produit dans un endroit où les gens risquent de marcher sur le cordon.

8. Ne surchargez pas les prises murales ni les cordons de rallonge afin d'éliminer tout risque d'incendie ou de choc électrique.
9. Prenez garde de ne pas déverser de liquide sur le produit.
10. Pour éliminer tout risque de choc électrique, évitez de désassembler le produit. Au besoin, confiez l'entretien ou la réparation du produit à un technicien qualifié.
11. Dans les cas suivants, débranchez le produit de la prise murale et confiez-en l'entretien à un technicien qualifié :
 - a) la fiche ou le cordon d'alimentation est endommagé ou dénudé;
 - b) le produit a été exposé à la pluie ou à l'eau, ou un autre liquide a été déversé sur le produit (débranchez le produit et laissez-le sécher afin de voir s'il fonctionne toujours, mais évitez de l'ouvrir);
 - c) le boîtier a été endommagé;
 - d) le rendement du produit semble se dégrader considérablement.
12. Évitez d'utiliser un téléphone pendant les orages électriques. Il existe un risque d'électrocution en raison de la foudre.
13. N'utilisez pas le téléphone pour signaler une fuite de gaz si vous vous trouvez à proximité de la fuite en question.
14. **MISE EN GARDE** : Pour éliminer toute possibilité de dommage accidentel aux cordons, aux fiches, aux prises et au téléphone, n'utilisez pas d'instruments tranchants pour son installation.
15. **AVERTISSEMENT** : Évitez de connecter l'extrémité libre du cordon du combiné directement dans une prise murale ou de plinthe. Ce genre de raccordement risque de produire des niveaux sonores dangereux ou d'endommager le combiné.
16. Conservez les présentes instructions.

ENTRETIEN ET RÉPARATION

Aucune des pièces qui renferment ces appareils ne peut être entretenue par l'utilisateur. Pour procéder à une réparation, retournez le téléphone à un revendeur Mitel autorisé.

Ces avis peuvent figurer sur le produit ou dans la documentation technique :

DANGER	La mention Danger indique une situation dangereuse imminente qui, si elle n'est pas évitée, entraîne la mort ou des blessures graves.
AVERTISSEMENT	Un avertissement indique une situation potentiellement dangereuse, laquelle, si elle n'est pas évitée, pourrait entraîner la mort ou des blessures graves.
MISE EN GARDE	Une mise en garde indique une situation potentiellement dangereuse, laquelle, si elle n'est pas évitée, pourrait entraîner une blessure légère ou moyenne, ou encore endommager l'équipement ou des biens.

Ce symbole peut figurer sur le produit :

	Le point d'exclamation à l'intérieur d'un triangle équilatéral indique que d'importantes consignes de fonctionnement et de maintenance (entretien courant) sont incluses dans la documentation fournie avec le produit.
---	---

Instrucciones y precauciones de seguridad importantes (América Latina)

ADVERTENCIA: EL TOMACORRIENTE DEBE ESTAR UBICAR CERCA DEL EQUIPO Y EL USUARIO DEBE TENER UN FÁCIL ACCESO A ÉL.

ADVERTENCIA: USE EL ADAPTADOR DE CA APROBADO POR MITEL, NÚMERO DE PIEZA 50006811.

ADVERTENCIA: EL AURICULAR QUE VIENE CON EL TELÉFONO NO ESTÁ CERTIFICADO PARA SU USO CON NINGÚN OTRO TELÉFONO. EL USO DE ESTE AURICULAR CON CUALQUIER OTRO TELÉFONO PUEDE CAUSAR LA PÉRDIDA DE LA AUDICIÓN EN CASO DE UNA DESCARGA ELÉCTRICA POR RAYOS EN EL CABLEADO EXTERIOR DE LA PLANTA. LA ZONA DEL PROTECTOR DEL AURICULAR DEL PRODUCTO ES LIGERAMENTE MAGNÉTICA Y PUEDE JUNTAR PEQUEÑOS OBJETOS METÁLICOS, COMO GRAPAS DE CALIBRE 26/6. REVISE QUE ZONA DEL PROTECTOR DEL AUDÍFONO NO TENGA OBJETOS METÁLICOS ANTES DE USARLO.

INSTALACIÓN

Para evitar choques eléctricos que pueden lesionar a personas o causar daño al equipo, observe las siguientes precauciones al instalar el equipo telefónico:

1. Nunca instale un cable telefónico durante una tormenta eléctrica.
2. Nunca instale conectores telefónicos en lugares mojados, a menos que el conector haya sido diseñado especialmente para lugares mojados.
3. Nunca toque alambres telefónicos o terminales sin aislante a menos que la línea telefónica haya sido previamente desconectada en la interfaz de la red.

USO

Al utilizar su equipo telefónico, observe siempre precauciones básicas de seguridad para evitar riesgos de incendio, choques eléctricos o lesiones a personas. Entre ellas:

1. Lea y asegúrese de que entiende todas estas instrucciones.
2. Siga tanto las advertencias como las instrucciones que aparecen en el producto.
3. Desconecte este producto de la toma de corriente mural antes de limpiarlo. No use productos de limpieza líquidos o a base de aerosol. Límpielo con un paño húmedo.
4. No utilice este producto cerca del agua; por ejemplo, cerca de una tina de baño, lavamanos, un lavatorio de cocina, lavadero de ropa, cerca de una piscina, o un sótano mojado.
5. No coloque este producto sobre una mesa de ruedas, un soporte, o mesa inestables. El producto podría caerse y estropearse.
6. Nunca se debe colocar este producto cerca de, o sobre, un radiador o una salida de calefacción. Nunca se lo debe colocar en una instalación empotrada a no ser que tenga una ventilación adecuada.
7. Cuide que no haya nada sobre el cordón de alimentación. No coloque el producto en un sitio donde la gente podría tirar o pisar el cordón de alimentación.
8. No sobrecargue las tomas murales ni las extensiones ya que podría causar un incendio o una descarga eléctrica.

9. Nunca vierta ningún tipo de líquido sobre el producto.
10. Para reducir el riesgo de descarga eléctrica, no desarme usted mismo(a) este producto. Cuando necesite servicio o reparación envíelo a un servicio técnico calificado.
11. Desenchufe este producto de la toma de corriente mural y envíelo a reparar a un servicio técnico calificado, en las situaciones siguientes:
 - a) Si el enchufe o el cordón de alimentación está estropeado o deshilachado.
 - b) Si el producto ha sido expuesto a la lluvia o al agua, o si se ha vertido otro tipo de líquido encima del producto, desconéctelo y déjelo secar para ver si todavía funciona, pero no lo abra.
 - c) Si la cubierta del producto ha sido dañada.
 - d) Si el producto muestra un cambio notorio en su funcionamiento.
12. Evite utilizar el teléfono durante una tormenta eléctrica. Puede haber probabilidades de descarga eléctrica causada por relámpagos.
13. No utilice el teléfono para avisar de un escape de gas cerca del escape.
14. **PRECAUCIÓN:** Para eliminar la posibilidad de dañar accidentalmente los cordones, enchufes, conectores y el teléfono mismo, no utilice instrumentos afilados durante el montaje.
15. **ADVERTENCIA:** No introduzca el enchufe del extremo libre del cordón del auricular directamente en un conector mural o de zócalo. Este uso indebido podría ocasionar niveles peligrosos de ruido y posibles daños al auricular.
16. Guarde estas instrucciones.

MANTENIMIENTO Y REPARACIÓN

Los teléfonos no contienen piezas útiles para el usuario. Para reparaciones, envíe el aparato a un distribuidor Mitel autorizado.

Estos avisos pueden aparecer en el producto o en la documentación técnica.

PELIGRO	Peligro indica una situación de riesgo inminente que, si no se evita, puede provocar la muerte o lesiones graves.
ADVERTENCIA	Advertencia indica una posible situación de peligro que, si no se evita, puede ocasionar la muerte o lesiones graves.
PRECAUCIÓN	Precaución indica una posible situación peligrosa que, si no se evita, puede ocasionar lesiones menores o moderadas y/o daños a los equipos o a la propiedad.

Este símbolo puede aparecer en el producto:

	El signo de exclamación dentro de un triángulo equilátero indica que se incluyen instrucciones importantes de operación y mantenimiento (servicio) en la información que acompaña al producto.
---	--

58014965 REV00

™, ® Trademark of Mitel Networks Corporation.
© Copyright 2016, Mitel Networks Corporation. All rights reserved.

™, ® Marque de commerce de Mitel Networks Corporation.
© Copyright 2016, Mitel Networks Corporation. Tous droits réservés.

™, ® Marca registrada de Mitel Networks Corporation.
© Copyright 2016, Mitel Networks Corporation. Todos los derechos reservados.

Printed in China