

MITEL NETWORKS

# 5215 | IP Phone

USER GUIDE

 **MITEL** | it's about **YOU**



# Contents

<b>INTRODUCTION</b>	<b>1</b>
<b>ABOUT THE DESKTOP TOOL</b>	<b>1</b>
<b>USING YOUR MITEL NETWORKS 5215 IP PHONE</b>	<b>2</b>
Your Mitel Networks 5215 IP Phone	3
Fixed Function Keys	5
Customising your Mitel Networks 5215 IP Phone	6
Programming your Keys	7
Account Codes	12
Alarm Calls	13
Answer External Call	14
Answer Next Call	14
Automatic Hold	15
Broker's Call (Shuttle)	16
Call Park	17
Call Park Pick-up	18
Call Status Information	19
Call Store	20
Call Transfer	21
Calls For	22
Directed Call Pick-up	22
Diverting	23
Divert All Calls	24
Divert on No Answer or Busy	27
Do Not Disturb (DND)	30
Doorphone Operation	31
Emergency 9-9-9 Calls	31
Exclusive Hold	32
Extension Paging	33
External Call Waiting Tone	34
External Divert	35
Follow Me	38
Follow Me (I'm Here)	41
Group Call Pick-up	42
Group Listen	42
Handsfree Operation	43
Immediate Divert	43
Intrude	44
Key Click Control	45
Last Call Cost Display	46
Last Call Duration Display	46

Last Number Redial	46
List of Calls	47
Loudspeaker Paging	47
Manager/Secretary (Absent/Present) Operation	48
Message Waiting	50
Messaging	52
MF (Multi-Frequency) Tone Dialling	53
Night Service Pick-up	53
Personal Speed Calls	54
PIN Codes	56
Priority Line Answer	57
Recall on Lines	57
Redial List	58
Re-establish	59
Reverted Calls	59
Ringback when Free	60
Ringer On/Off	61
Selective Ringer	62
Split Divert	63
System Hold	65
System Speed Call Numbers	66
Three-Party Conference	67
Withhold Identity	67
Who Am I?	68
<b>TIPS FOR YOUR COMFORT AND SAFETY</b>	<b>69</b>
<b>GLOSSARY</b>	<b>70</b>
<b>ACCESSING FEATURES</b>	<b>75</b>
<b>FEATURE ACCESS CODES</b>	<b>76</b>

# INTRODUCTION

This Extension User Guide provides detailed operating information for using the Mitel Networks 5215 IP Phone on the Mitel Networks 3100 Integrated Communications Platform (ICP).

You can perform all the features listed in this User Guide, either by pressing a programmed personal key, via **SuperKey** or by dialling a feature access code. Some features must be enabled or configured by your Administrator before they can be used.

This Guide is arranged in the following sections:

- Introduction lists the sections in this Guide;
- Using your Mitel Networks 5215 IP Phone guides you around your Mitel Networks 5215 IP Phone and describes the functions of keys on your phone, how to customise your phone, how to program your personal keys and the features available to you;
- Introduction to the Desktop User Tools familiarises you with the Desktop User Tools;
- Tips for your Comfort and Safety gives you advice on using your extension;
- Glossary lists the terms that are used in this User Guide which you may not be familiar with;
- Accessing Features lists the feature access codes.

## ABOUT THE DESKTOP TOOL

The Desktop Tool, available with the Mitel Networks 3100 Integrated Communications Platform (ICP) , enables you to manage the following from your PC:

- assign features to your personal keys;
- set up entries in your Personal Directory which can be assigned to your personal keys;
- change your password.

The features that can be assigned to your personal keys are described in more detail in the next section.

Contact your Administrator for information on accessing the Desktop Tool.

# USING YOUR MITEL NETWORKS 5215 IP PHONE

This section guides you around your Mitel Networks 5215 IP Phone and includes the use of all keys on your phone, how to customise your phone, how to program your personal keys and the features available to you.

The features described in this section can be accessed via **SuperKey**, via a programmed personal key or by dialling a feature access code.

The feature access codes shown under *Accessing Features* and described throughout this Extension User Guide, show the leading digit as "6", for example, 6xx, which is the system default. However, if the numbering plan is modified, an alternative leading digit may be used.

Check with your Administrator to ensure that these feature access codes are correct for your system.

## Your Mitel Networks 5215 IP Phone



Figure 1, Mitel Networks 5215 IP Phone

The Mitel Networks 5215 IP Phone features dual ports which allows your PC and telephone to share a single network connection, an easy-to-read display, a Message Waiting Indicator, seven fixed-function keys, six personal keys and two arrow keys (▲ and ▼).

The easy-to-read display comprises of a two-line, 20-character, alpha-numeric Liquid Crystal Display (LCD) which gives a visual indication of the current status of your extension.

The Message Waiting Indicator is used in conjunction with the **Message** key; its function is described in more detail under Message Waiting.



The seven fixed-function keys are: **SuperKey**, **Trans/Conf**, **Shift**, **Message**, **Hold**, **Cancel**, and **Intercom**; these keys, and the ▲ and ▼ keys, are described in detail under Fixed Function Keys.

*Each personal key may be programmed with:*

- a feature;
- an extension number;
- an extension group number;
- line number;
- line group number, or
- System or Personal Speed Call number.

Every personal key has a dual-coloured (orange and red) light associated with it which gives the status of an extension, extension group, line, line group or feature programmed under the key. The key's light gives the status of the extension (Busy Lamp Field). This key can also be used to directly dial, transfer a call to, or pick up a call ringing at the extension (Direct Station Selection). Refer to *Using your Mitel Networks 5215 IP Phone* for detailed operating instructions on programming and using the personal keys.

Frequently-dialled external numbers (Personal Speed Calls) may also be stored as a secondary feature under any of the twelve keypad keys. To dial a Personal Speed Call stored under a keypad key or under a personal key at the secondary level, press **Shift** followed by the key under which the number is stored. Refer to *Personal Speed Calls* for more information on setting up and using this feature.

The  and  keys, positioned above the keypad, are used to control the handset, ringer and loudspeaker volume, plus the display contrast on the LCD. Refer to *Tips for your Comfort and Safety* for more information on changing the volume.

The base of the telephone tilts to provide a better view of the keys and display. The telephone is also equipped with a dedicated headset jack, which eliminates the need for an amplifier box when used with Mitel Networks headsets. For more information refer to *Tips for your Comfort and Safety*.



## Fixed Function Keys

The following fixed function keys are available on your Mitel Networks 5215 IP Phone. These key functions cannot be modified or deleted:

### SuperKey

Used for programming features under personal keys and setting up call diversions.

### Hold

Used for placing and retrieving callers on hold.

### Message

Used to leave a message waiting indicator at another extension. The called extension can call you back by pressing **Message**. This key is used in conjunction with the Message Indicator which flashes when you have a message waiting. Refer to *Message Waiting* for more information.

### Cancel

Used to cancel the current operation and return you to dial tone. Pressing this key is equivalent to replacing your handset and lifting it up again. When this key is pressed during programming using **SuperKey**, you are returned to the previous programming step.

### Trans/Conf

Used to temporarily place a call on hold before transferring to another party, and to initiate a three-party conference call.

### Shift

Used to program and access Personal Speed Call numbers saved as secondary features under personal keys and keypad keys.

Pressing **Shift** twice redials the last externally-dialled number.

### Intercom

Used to indicate calls for your extension and allows you to retrieve calls from hold. When a call arrives at your extension, **Intercom** flashes with ringing cadence. The call can then be answered by picking up the handset or pressing **Intercom**. After answering an incoming call, **Intercom** lights red, indicating that a call is in progress.





Used to change the ringing, handset and loudspeaker volume, plus the display contrast on the LCD. These keys are also used to navigate through the Phonebook.

## Customising your Mitel Networks 5215 IP Phone

The ringing, handset, headset and speaker volume are all adjustable and so are the ringing pitch and the display contrast.

All the volume settings are separate, so changing one does not impact the others.



### Ringer Control

To adjust the ringer volume whilst your extension is ringing, press  to increase the volume and  to decrease the volume.



### Ringer Pitch

You can adjust the ringing characteristics of your Mitel Networks 5215 IP Phone to distinguish it from other phones in the area by adjusting the ring pitch.



*To adjust the Ringer Pitch whilst your extension is idle:*

1. Lift the handset.
2. Dial the Ringer Pitch feature access code, **651**.  
*Your extension starts to ring continuously.*
3. Press  to increase the pitch and  to decrease the pitch.
4. When you are satisfied with the pitch, replace the handset or press **Speaker**.



### Handset Receiver Volume Control

To adjust the Handset Receiver volume when you are using the handset, press  to increase the volume and  to decrease the volume.

### Speaker Volume Control

To adjust the Speaker volume during a handsfree conversation, press  to increase the volume and  to decrease the volume.

### Display Contrast Control

To adjust the contrast control on your telephone's LCD, press  to increase the display contrast and  to decrease the contrast.

## Programming your Keys

### Programming a Personal Key

Every personal key on your Mitel Networks 5215 IP Phone can be programmed to store a feature and a speed call number. You can assign one feature to each personal key.

Additionally, Personal Speed Call numbers can be stored under a personal key along with a feature. The numbers are stored at the "secondary" level and are described in more detail under *Personal Speed Calls*.

The following instructions describe how to program your personal keys with a feature. The first set of instructions describe how to program a key which does not require mandatory information, that is, does not require the inclusion of an extension number. The second set of instructions describe how to program a key which requires mandatory information.

**Note** : When programming your keys, you can press **SuperKey** at any time to leave programming, or press **Cancel** to return to the previous menu.

*To program a personal key which does not require mandatory information:*

1. Press **SuperKey**.
2. Press **#** repeatedly until PERSONAL KEYS? is displayed.
3. Press **\***.
4. Press the key to be programmed.  
*If a feature or speed call is already stored under the selected key, it is displayed with the option to change or clear the key.  
Press \* to change the key or # to clear the key.*
5. Press **\*** to change the key.
6. Press **#** repeatedly to scroll down the list of available features until the desired feature is displayed.
7. Press **\*** to select the feature and save under the chosen key.
8. Press **#** to save under the chosen key.
9. Press **SuperKey** to complete the operation or press another personal key and proceed to program another feature.
10. Write the feature name on the key label.

*To program a personal key which requires mandatory information:*

1. Press **SuperKey**.
2. Press **#** repeatedly until PERSONAL KEYS? is displayed.
3. Press **\***.
4. Press the key to be programmed.  
*If a feature or speed call is already stored under the selected key, it is displayed with the option to change or clear the key.  
Press \* to change the key or # to clear the key.*
5. Press **\*** to change.
6. Press **#** repeatedly to scroll down the list of available features until the desired feature is displayed.
7. Press **\*** to select the feature.
8. Dial the additional information, for example, the extension number.  
*You cannot proceed until the mandatory information is included.*
9. Press **#** to save under the chosen key.
10. Press **SuperKey** to complete the operation or press another personal key and proceed to program another feature.
11. Write the feature name on the key label.

## Removing a Feature from a Personal Key

1. Press **SuperKey**.
2. Press **#** repeatedly until PERSONAL KEYS? is displayed.
3. Press **\*** to select this option.
4. Press the key to be cleared.  
*The feature currently stored is displayed.*
5. Press the **#** to clear the key.  
*The key's feature is removed.*
6. Press **SuperKey** to end programming.

Alternatively, you can follow the steps described above but press the **\***, instead of the **#** key, to re-program the key to another feature as described above.

## Programming a DSS/BLF key

A **DSS/BLF** (Direct Station Selection/Busy Lamp Field) key allows you to call another extension user with a single key press. The **DSS/BLF** key lights to indicate the status of the extension:

*Table 1, DSS/BLF Key Status on a 5215 IP Phone*

<b>Key Status</b>	<b>Explanation</b>
Lit (orange)	Programmed extension is busy, off-hook, or has set Do Not Disturb.
Lit (red)	You are connected to the extension programmed under this key.
Unlit	The extension is idle.
Flashing (orange) with ringing cadence	Programmed extension is ringing and the call can be picked up by the extension with the <b>DSS/BLF</b> key.
Flashing (red) with ringing cadence	Programmed extension is calling your extension.
Flashing (orange) with held cadence	Programmed extension has placed a call on System Hold and the call can be picked up.
Flashing (red) with held cadence	You have placed this extension on System or Exclusive Hold.
Flashing (Red) with queued ringing cadence	The extension is busy and has another call queued. You can pick up the queued call by pressing the <b>DSS/BLF</b> key.

To program a DSS/BLF key:

1. Press **SuperKey**.
2. Press **#** repeatedly until PERSONAL KEYS? is displayed.
3. Press **\*** to select this option.
4. Press the personal key to be programmed.  
*If a feature or speed call is already stored under the selected key, it is displayed with the option to change or clear the key.*  
*Press \* to change the key or # to clear the key.*
5. Press **\*** to change the feature stored under the selected key.
6. Press **#** repeatedly to scroll down the list of features until **DSS/BLF** is displayed.
7. Press **\*** to select this option.
8. Dial the required extension number.  
*If you make a mistake when dialling the extension number, press \* repeatedly to remove the incorrect digits.*
9. Press **#** to save the extension number under the selected personal key.  
*If you dial an invalid extension number, the system will not allow you to save the extension number, that is, pressing # has no effect.*
10. Press **SuperKey** to complete the operation or press another personal key and proceed to program another feature.
11. Write the extension number on the key label.

### Programming an EXTENSION GROUP key

An **EXTENSION GROUP** key allows you to call an extension group with a single key press. Membership of an extension group is set up by your Administrator, and an extension group can be, for example, all members of the Sales Department. When an extension group is called, all extensions in the group ring until the call is answered.

Contact your Administrator for a list of extension group numbers.

The **EXTENSION GROUP** key light indicates the status of an extension group:

**Note** : You cannot be a member of the extension group that you are attempting to program under a personal key.

To program an EXTENSION GROUP key:

1. Press **SuperKey**.
2. Press **#** until PERSONAL KEYS? is displayed.
3. Press **\*** to select this option.
4. Press the key to be programmed.  
*If a feature or speed call is already stored under the selected key, it is displayed with the option to change or clear the key.*  
*Press \* to change the key or # to clear the key.*
5. Press **\*** to change the feature stored under the selected key.
6. Press **#** repeatedly to scroll down the list of features until **EXTENSION GROUP** is displayed.
7. Press **\*** to select this option.
8. Dial the required extension group number.  
*If you make a mistake when dialling the extension group number, press \* repeatedly to remove the incorrect digits.*
9. Press **#** to save the extension group number under the selected personal key.  
*If you dial an invalid extension group number, the system will not allow you to save the extension group number, that is, pressing # has no effect.*
10. Press **SuperKey** to complete the operation or press another personal key and proceed to program another feature.
11. Write the extension group number on the key label.

## Programming a LINE key

A **LINE** key allows you to access and answer calls on a specific external line.

The **LINE** key light indicates the status of a line:

Table 2, LINE Key Status on a 5215 IP Phone

Key Status	Explanation
Lit (orange)	The line is in use at another extension.
Lit (red)	The line is in use at your extension.
Unlit	The line is idle.
Flashing (orange) with ringing cadence	An external call is ringing on this line and can be answered by any extension user.
Flashing (orange) with held cadence	The external call, on this line, is held on System Hold and any extension user can pick up the call.
Flashing (red) with held cadence	You have placed this line on System or Exclusive Hold.

To program a LINE key:

1. Press **SuperKey**.
2. Press **#** until PERSONAL KEYS? is displayed.
3. Press **\*** to select this option.
4. Press the key to be programmed.  
*If a feature or speed call is already stored under the selected key, it is displayed with the option to change or clear the key.  
Press \* to change the key or # to clear the key.*
5. Press **\*** to change the feature stored under the selected key.
6. Press **#** repeatedly to scroll down the list of features until **LINE** is displayed.
7. Press **\*** to select this option.
8. Dial the required number in three-digit format, for example , 001.  
*If you make a mistake when dialling the line number, press \* repeatedly to remove the incorrect digits.*
9. Press **#** to save the line number under the selected personal key.  
*If you dial an invalid extension group number, the system will not allow you to save the line number, that is, pressing # has no effect.*
10. Press **SuperKey** to complete the operation or press another personal key and proceed to program another feature.
11. Write the line number on the key label.

## Programming a LINE GROUP key

A **LINE GROUP** key allows an extension user to access and answer calls from that line group with a single key press. The **LINE GROUP** key light indicates the status of a line group:

Table 3, LINE GROUP Key Status on a 5215 IP Phone

Key Status	Explanation
Lit (orange)	All lines in the line group are busy
Unlit	At least one line in the line group is idle
Flashing (orange)	Line group is ringing

To program a **LINE GROUP** key:

1. Press **SuperKey**.
2. Press **#** until **PERSONAL KEYS?** is displayed.
3. Press **\*** to select this option.
4. Press the key to be programmed.  
*If a feature or speed call is already stored under the selected key, it is displayed with the option to change or clear the key.  
Press **\*** to change the key or **#** to clear the key.*
5. Press **\*** to change the feature stored under the selected key.
6. Press **#** repeatedly to scroll down the list of features until **LINE GROUP** is displayed.
7. Press **\*** to select this option.
8. Dial the required line group number in two-digit format, for example, 02.  
*If you make a mistake when dialling the extension group number, press **\*** repeatedly to remove the incorrect digits.*
9. Press **#** to save the line number under the selected personal key.  
*If you dial an invalid line group number, the system will not allow you to save the line group number, that is, pressing **#** has no effect.*
10. Press **SuperKey** to complete the operation or press another personal key and proceed to program another feature.
11. Write the line group number on the key label.

## Account Codes

An account code is a series of digits that you assign to your incoming or outgoing calls, usually for billing or accounting purposes. The code identifies the account in the call records that your system generates. You can program an **ACCOUNT CODE** key with or without specifying an account code. If you have an account code that you use on a regular basis, it may be easier to program it to the **ACCOUNT CODE** key; this saves you from having to dial the code every time you want to assign it to a call.

Account codes must be between three and twenty digits long and in the range 000-999999999999999999.

### Notes:

1. Contact your Administrator for a list of account codes.
2. You must have a pre-programmed **EXCLUSIVE HOLD** key set up on your extension to use this feature. Refer to *Exclusive Hold* for more information on the use of this feature.

### PROGRAMMING

Program an **ACCOUNT CODE** key and **EXCLUSIVE HOLD** key as described under *Programming a Personal Key*.

**Note:** An **ACCOUNT CODE** key can be saved with or without the inclusion of an account code.

### Allocating an Account Code to an Outgoing Call

*If you have an ACCOUNT CODE key programmed with a specific account code:*

1. Press the **ACCOUNT CODE** key.
2. Access a line and dial the external number.

*If you have an ACCOUNT CODE key without a specific account code programmed:*

1. Press the **ACCOUNT CODE** key.
2. Dial the required Account Code.
3. Access a line and dial the external number.

*If you do not have an ACCOUNT CODE key programmed:*

1. Dial the Account Code feature access code, **665**.
2. Dial the required Account Code.
3. Access a line and dial the external number.



## Allocating an Account Code to a Call in Progress

If you wish to change the account code associated with an incoming or outgoing call, perhaps a call has been transferred to you from a department with a different account code, you may assign a different account code whilst connected to the call. In this way numerous account codes can be associated with one call.

*If you have an ACCOUNT CODE key programmed with a specific account code:*

1. Whilst in conversation with another party, press the **EXCLUSIVE HOLD** key.
2. Press the **ACCOUNT CODE** key.
3. Press the **EXCLUSIVE HOLD** key again.

*The caller is re-connected and the call assigned with the new account code.*

*If you have an ACCOUNT CODE key without a specific account code programmed:*

1. Whilst in conversation with another party, press the **EXCLUSIVE HOLD** key.
2. Press the **ACCOUNT CODE** key.
3. Dial the required account code.
4. Press the **EXCLUSIVE HOLD** key again.

*The caller is re-connected and the call assigned with the new account code.*

*If you do not have an ACCOUNT CODE key programmed:*

1. Whilst in conversation with another party, press the **EXCLUSIVE HOLD** key.
2. Dial the Account Code feature access code, **665**.
3. Dial the required account code.
4. Press the **EXCLUSIVE HOLD** key again.

*The caller is re-connected and the call assigned with the new account code.*

## Alarm Calls

You can set up an alarm (wake-up or reminder) call to ring at your extension at a specified time. You must answer a ringing alarm call before you can continue with any other operation at your extension.

When you receive an alarm call, your extension rings for up to 60 seconds (default) or until you answer the call. If you do not answer the call within this time period, your extension rings again every 2 minutes (default); this process is repeated up to a maximum of ten times or until you answer your alarm call.

### Notes:

1. An alarm call is not repeated on successive days, which means that you must set up the alarm call daily.
2. Your Administrator can set up an alarm call for you. Contact your Administrator for details.

## OPERATION

*To set up an Alarm Call from your extension:*

1. Dial the Alarm Call feature access code, **668**.
2. Dial the time using the 24-hour clock.  
*You hear dial tone indicating that the alarm is set.*

*To cancel an Alarm Call:*

- Dial the Alarm Call Cancel feature access code, **669**.

## Answer External Call

If you want to answer external calls in the order that they arrive at your extension, you need to program an **ANSWER EXTERNAL** key. You answer the incoming call by pressing the flashing, pre-programmed **ANSWER EXTERNAL** key. Your **ANSWER EXTERNAL** key continues to flash until all incoming external calls have been answered.

### PROGRAMMING

Program the **ANSWER EXTERNAL** key as described under *Programming your Keys*.

### OPERATION

**Note:** You must have a pre-programmed **ANSWER EXTERNAL** key set up on your extension to use this feature.

*To answer external calls using the ANSWER EXTERNAL key:*

- Press the flashing **ANSWER EXTERNAL** key.  
*The ANSWER EXTERNAL key continues to flash until all the incoming external calls have been answered.*

## Answer Next Call

This feature is similar to Answer External Call except that it applies to ALL incoming internal and external calls. Answer Next Call allows you to answer all calls in the order that they arrive at your extension with external calls receiving priority over internal calls. You answer the incoming call by pressing the flashing, pre-programmed **ANSWER NEXT CALL** key. The **ANSWER NEXT CALL** key continues to flash until you have answered all the calls.

**Note:** You can only answer incoming internal calls using this feature if the calling extension number is in your extension group. Contact your Administrator for a list of extensions in your extension group.

### PROGRAMMING

Program the **ANSWER NEXT CALL** key as described under *Programming your Keys*.

### OPERATION

**Note:** You must have a pre-programmed **ANSWER NEXT CALL** key set up on your extension to use this feature.

*To answer internal and external calls in the order that they arrive at your extension:*

- Press the flashing **ANSWER NEXT CALL** key.  
*The ANSWER NEXT CALL key continues to flash until all incoming calls have been answered.*

## Automatic Hold

Whilst in conversation with another party, this feature allows you to make or receive a call without placing the current call on hold first.

### OPERATION

#### Outgoing Calls

*To place the current call on Automatic Exclusive Hold and make another call:*

- Whilst in conversation with an established call, make another call.  
*The caller placed on hold hears silence, tone or music on hold. The call is held under **Trans/Conf**. Any associated **DSS/BLF** or **LINE** keys light solid orange. You hear dial tone.*

*To return to the call placed on hold:*

- Press **Hold**, or if a pre-programmed key is available, press the appropriate flashing **DSS/BLF** or **LINE** key.

*To transfer the held party to the newly-called party:*

- Whilst in conversation with the newly-called party, replace your handset or press **Speaker**.

#### Incoming Calls

*To place the current call on Automatic System Hold and answer an incoming call:*

1. Whilst in conversation with an established call, press the flashing key which is indicating the incoming call.
2. Handle the new call as usual.

*To return to the held call:*

- While your extension is idle, press **Hold**, or if the call has as associated **DSS/BLF** or **LINE** key, press this key.

## Broker's Call (Shuttle)

This feature enables you to place a call on hold, dial another number, talk to the second party and then alternate between the two parties by pressing the **SHUTTLE** key. This feature allows you to speak to both the first and second parties in confidence; at no time during the use of this feature can the two parties converse with each other.

**Note:** You can alternate between the two parties any number of times.

### PROGRAMMING

Program a **SHUTTLE** key as described under **Programming a Personal Key**.

### OPERATION

**Note:** You must have a pre-programmed **SHUTTLE** key set up on your extension to use this feature.

*Whilst in conversation with an established external call:*

1. Press the **EXCLUSIVE HOLD** button to place the established call on hold.
2. Replace the handset to free your prime line key (not necessary if you are using the handsfree option).
3. Lift the handset, and then dial the number of the party that you wish to consult.
4. Talk to the second party.
5. Talk to the second party.
6. Return to the held call by pressing the **SHUTTLE** key.  
*The second party is placed on hold.*
7. Press the **SHUTTLE** key to alternate between the two parties.

## Call Park

This feature allows you to answer an external call and place it in a type of hold which enables anyone on the system to retrieve it. You inform another extension user that a call is waiting to be answered on a specific line using the Extension Paging feature. The extension user picks up the call by dialling the Call Park Pick-up feature access code, **660**, followed by the specified line number.

Refer to *Call Park Pick-up* for more information on retrieving a parked call, and to *Extension Paging* for information on broadcasting to other extension users.

### PROGRAMMING

Program the **PARK** key as described under *Programming a Personal Key*.

### OPERATION

**Note:** You must have a pre-programmed **PARK** key set up on your extension to use this feature.

*To park an incoming external call:*

1. After answering the call, press the **PARK** key.  
*If programmed, the LINE key flashes red and a message similar to the following is displayed:  
LINE 001 HELD.*
2. Press the **EXTENSION PAGING** key to announce the call.  
*When the call is picked up, your LINE key lights solid orange, if programmed.  
If the call is not picked up, press the flashing LINE key, if programmed, and speak to the caller.*

*To retrieve an unanswered parked call:*

- Whilst your extension is idle, press the relevant **LINE** key, if programmed.  
*You are connected to the parked call.*

*Alternatively:*

1. Dial the Call Park Pick-up feature access code, **660**.
2. Dial the line number, using the two-digit format, for example, 01.  
*You are now connected to the parked call.*

## Call Park Pick-up

This feature allows you to pick-up an external call held on a specific line by another extension user by dialling the Call Park Pick-up feature access code followed by the line number.

An extension user broadcasts a message informing you that you have a call waiting to be answered and on which line the call is held. To retrieve the call you must dial the Call Park feature access code followed by the line number on which the call is waiting. For more information on parking a call refer to *Call Park*.

**Note:** Your Administrator can set up the system so that a single-digit can be used to pick-up the call instead of using the three-digit access code. Contact your Administrator for a list of single-digit access codes.

### OPERATION

On receiving a broadcast message of a call waiting to be answered on a specific line for you:

1. Dial the Call Park Pick-up feature access code, **660**.
2. Dial the line number, using the two-digit format, for example, 01.

*You are now connected to the caller.*

**Note:** Refer to *System Hold* for detailed information on picking up calls in this way.

*Alternatively:*

- If you have an associated *LINE* key programmed at your extension, press the flashing *LINE* key.  
*You are now connected to the caller.*

**Note:** Refer to *System Hold* for detailed information on picking up calls in this way.

## Call Status Information

Your LCD provides information (listed below) about the status of your extension and of the current call.

*Table 4, Call Status Information and Feature Messages*

<b>Key Status</b>	<b>Explanation</b>
ALARM CALL RINGING	An alarm call is ringing at your extension.
ALARM CALL ANSWERED	You have answered an alarm call.
BCAST FROM EXT xxxx	You are receiving a broadcast message from the displayed extension.
BROADCAST ALL	You are broadcasting a message to all extensions on the system.
BROADCAST GROUP xx	You are broadcasting a message to a specific extension group.
DO NOT DISTURB	Do Not Disturb is active at your extension.
CONTACT INSTALLER	The incoming call is on a line that doesn't have a line number.
EXT xxxx ANSWERED	The called extension has answered.
EXT xxxx BUSY	The called extension is busy.
EXT xxxx CALLING	The displayed extension is ringing.
EXT xxxx DND	The called party has Do Not Disturb activated.
EXT xxxx DIVERTED	The called extension is currently diverting incoming calls.
EXT xxxx HELD	The specified extension is on hold at your extension.
EXT xxxx RINGBACK	The call that you transferred to a specific extension, has returned to your extension because the called extension did not answer.
EXT xxxx RINGING	The extension number you dialed is ringing.
EXT xxxx SPEAKING	You are currently speaking to the displayed extension.
GROUP xx RINGING	The extension group number you dialed is ringing.
LINE xx ANSWERED	You have answered a call on the specified line.
Lxx REV EXT xxxx	The call on line XX has reverted from the displayed extension.
Lxx R EXT GRP xx	The call on line number XX has reverted from the displayed extension group.
LINE xx HELD	You have placed an external call on hold.
LINE xx REVERTED	An external call has reverted to the originating extension.
LINE xx RINGING	You have an incoming call on the specified line.
LISTEN EXT xxxx	You are receiving a broadcast message from the displayed extension.
MESSAGE WAITING	You have a message waiting to be answered at your extension.
NIGHT SERVICE x	The specified Night Service is active.
RINGER ON/OFF	Your extension's ringer is switched off.
SPEAK EXT xxxx	You are broadcasting a message to the displayed extension.
THIS IS EXT xxxx	Displays your extension number.
THREE PARTY	You are currently involved in a three-party conference call.
XX CALLS WAITING	The number of calls waiting to be answered at your extension.

**Note:** Where systems are setup with six-digit extension or extension group numbering, shortened messages are displayed.

## Call Store

This feature allows you to place a call on hold under a key and leave it on hold for a length of time determined by system programming. You can program up to six **STORE** keys on your extension. This allows you to have up to six calls on hold at your extension.

### Notes:

1. The number of **STORE** keys you can have programmed at your extension is limited only by the number of available personal keys.
2. A stored call cannot be picked by another extension user and you cannot transfer the stored call to another extension.

### PROGRAMMING

Program **STORE** keys as described under *Programming a Personal Key*.

**Note** : When requested, dial the **STORE** key's number in two-digit format, for example, 01.

### OPERATION

**Note:** You must have a pre-programmed **STORE** key set up on your extension to use this feature.

*To store a call whilst in conversation with another party:*

- Press a **STORE** key.  
*The chosen **STORE** key flashes red with held cadence and you hear dial tone.*

*To retrieve a call:*

- Whilst your extension is idle, press the flashing **STORE** key.



## Call Transfer

This feature allows you to move a call from your extension to another.

### OPERATION

*To make an announced transfer:*

1. Whilst in conversation with an established call, press **Trans/Conf**.  
*You hear dial tone.*
2. Press a **DSS/BLF** key or dial the extension number or external number.  
*You hear ringing tone.*
3. If the extension user or external called party answers, speak to the called party and ask them if they wish to take the call.
4. If the called party accepts the call, replace your handset.  
*The call is automatically transferred to the called number.*
5. If the called party does not accept the call, press the **Cancel** key.  
*The call is returned to you.*

*To make an unannounced transfer:*

1. Whilst in conversation with an established call, press **Trans/Conf**.  
*You hear dial tone.*
2. Press a **DSS/BLF** key or dial the extension number or external number.  
*You hear ringing tone.*
3. Replace your handset.  
*The call is automatically transferred to the called number.*

**Note:** If the call is unanswered, it returns to your extension (external calls) or is cleared by the system (internal calls).

*To retrieve the held call from transfer:*

- While your extension is idle, press the **Cancel** key.

## Calls For

This feature identifies the extension number of a user who has diverted calls to your extension. When a diverted call is presented at your extension, the labeled **CALLS FOR** key flashes orange, and your LCD temporarily displays who the call was originally intended for. Press the **CALLS FOR** key to answer the call (with the appropriate greeting). If a number of extension users divert their calls to you regularly, you can set up a **CALLS FOR** key for each extension.

If your extension is set up for Manager/Secretary working and you have a programmed **CALLS FOR** key, the **CALLS FOR** key lights solid orange when the Manager/Secretary is absent. If your extension is set up as a Secretary extension involved in one-to-one Manager/Secretary working, and you have a **CALLS FOR** key programmed for your Manager, you can press this key to toggle the Manager's extension to the absent or present state. Refer to **Manager/Secretary** Operation for more information.

**Note:** The **CALLS FOR** key should be labeled with the name or number of the diverting extension.

### PROGRAMMING

Program a **CALLS FOR** key as described under *Programming a Personal Key*.

### OPERATION

*To answer a call diverted from another extension:*

- Press the flashing **CALLS FOR** key.

## Directed Call Pick-up

This feature allows you to pick up a call which is ringing at another extension which is not in your pick-up group. If there is more than one call ringing at an extension when you activate this feature, the call with the highest priority is answered, that is, an external call will always be answered before an internal or reverted call.

**Note:** Your Administrator can set up the system so that a single-digit can be used to pick-up the call instead of using the three-digit access code.

Contact your Administrator for a list of single-digit access codes.

### OPERATION

*To answer a call that is ringing at another extension:*

- If programmed, press the flashing **DSS/BLF** key.  
*You are connected to the caller of the ringing extension.*  
*Or*
- Dial the Directed Call Pick-up feature access code, **677**, followed by the ringing extension's number.  
*You are connected to the caller of the ringing extension.*  
*Or*
- Dial the single-digit Directed Call Pick-up access code, followed by the ringing extension's number.  
*You are connected to the caller of the ringing extension.*

## Diverting

Incoming internal and external calls presented at your extension can be diverted in the following ways:

- Divert All Calls - diverts all your calls to another extension or extension group without first presenting the calls at your extension. See Divert all Calls.
- Divert on No Answer or Busy - diverts your calls to another extension or extension group when you are busy on another call or away from your desk. See Divert on No Answer or Busy.
- Follow Me and Follow Me (I'm Here) - diverts your calls to another extension where you wish to take your calls. See Follow Me and Follow Me (I'm Here).
- Manager/Secretary - diverts all your calls to another extension when you do not wish to receive calls or away from your desk. See *Manager/Secretary Operation* and *Calls For*.
- External Divert - diverts all your incoming calls to an external destination; for example, a mobile phone or you home number. See External Divert.

Each type of diversion can be programmed via **SuperKey**, under a personal key and invoked by pressing that key, or by dialling the appropriate feature access code.

**Note:** You can also divert your calls to Voice Mail, if available. The Voice Mail extension number that you divert your phone to is usually 232. Your administrator can tell you what the number is on your system.

## Divert All Calls

This feature allows you to divert all your calls to another extension or an extension group without ringing at your extension first. If you always divert your calls to the same extension or extension group, you can program a **DIVERT ALL CALLS** key with this number. Alternatively, you can program the **DIVERT ALL CALLS** key without specifying a destination number, which means that you must dial an extension or extension group number each time you want to divert your calls. You can set up a number of **DIVERT ALL CALLS** keys on your extension, each holding a different destination extension or extension group number.

This feature can be set up using **CALL DIVERT** under **SuperKey** and does not have to be programmed under a personal key. Refer to the operation described below.

### PROGRAMMING

1. Press **SuperKey**.
2. Press **#** repeatedly until PERSONAL KEYS? is displayed.
3. Press **\*** to select this option.
4. Press the key to be programmed.  
*If a feature is already stored under the selected key, the existing feature is displayed with the option to change or clear the key.*
5. Press **\*** to change the feature stored under the selected key.
6. Press **#** repeatedly to scroll down the list of available features until **CALL DIVERT** is displayed.
7. Press **\*** to select this option.
8. Press **\*** at the **ALWAYS** prompt.  
*At this point, you can choose to program the key with or without a destination extension or extension group.*
9. Either, dial an extension number or extension group number, followed by **Save** to save the dialled number.
10. Alternatively, press **\*** to divert all your calls to an extension or **#** to divert all your calls to an extension group.  
*When the key is pressed, you must dial an extension number or extension group number before the diversion is active.*
11. Press **SuperKey** to complete the operation.

## OPERATION

**Note:** If you activate a divert using **SuperKey**, and a diversion is active via a programmed **DIVERT ALL CALLS** key, the current diversion is overridden, and vice versa.

### Diverting your calls using SuperKey

*To divert all your calls to another extension or extension group using SuperKey:*

1. Press **SuperKey**.
2. *CALL DIVERT?* is displayed.
3. Press \* to select the feature.  
*ALWAYS is displayed.*
4. Press \* to review the number stored.  
*If programmed, ALWAYS is displayed along with a target extension number or extension group number.*  
*If a target extension number or extension group number is displayed prefixed with an asterisk, it indicates that a diversion is already active.*

*If a target extension number or extension group number has not been programmed, you are prompted to dial an extension number:*

5. Press \* to change the number stored.
6. At the TO: prompt, dial the extension number you wish to divert your calls to.  
*If you make a mistake when dialling the extension number, press \* to remove the incorrect digits.*
7. Press # to save the extension number.  
*If you dial an invalid extension number or extension group number, the system will not allow you to save the number.*

*If a target extension number or extension group number has been programmed:*

8. Press \* to display the programmed number.
9. Press # to activate the diversion to the displayed number.  
*ALWAYS is displayed with the target extension or extension group number prefixed with an asterisk. The asterisk indicates that the diversion is now active.*
10. Press **SuperKey** to complete the operation.  
*When you lift your handset, you hear interrupted dial tone indicating that your calls are being diverted.*

## Diverting your calls using a programmed key

To divert all your calls using a key programmed with a destination extension or extension group number:

- Press a specific **DIVERT ALL CALLS** key.  
The **DIVERT ALL CALLS** key lights solid orange. When you lift your handset, you hear interrupted dial tone indicating that you are diverting your calls.

To divert all your all calls to another extension or extension group using a key which does not have an extension or extension group programmed:

1. Press a specific **DIVERT ALL CALLS** key.
2. Dial an extension or extension group number, or press a **DSS/BLF** or **EXTENSION GROUP** key.  
The associated **DIVERT ALL CALLS** key lights solid orange. When you lift your handset, you hear interrupted dial tone indicating that you are diverting your calls.

To divert your calls when you hear Call Waiting tone whilst in conversation:

- Press a **DIVERT ALL CALLS** key programmed with a destination extension or extension group number.  
The incoming call is diverted.

## Diverting your calls using the feature access code

To divert your calls using a feature access code:

1. Dial one of the following codes:
  - **611** - Divert Always to an Extension
  - **618** - Divert Always to an Extension Group
2. Dial an extension or extension group number, or press a **DSS/BLF** or an **EXTENSION GROUP** key.  
When you lift your handset, you hear interrupted dial tone indicating that you are diverting your calls.

## Cancelling

To cancel a diversion using SuperKey:

1. Press **SuperKey**.  
*CALL DIVERT?* is displayed.
2. Press \* to select the feature.  
*ALWAYS* is displayed.
3. Press \* to select the feature.  
*ALWAYS ALL* is displayed.
4. Press \*.  
*ALWAYS ALL* is displayed along with a target extension number or extension group number prefixed with an asterisk.
5. Press \* to change the diversion.
6. Press # to turn off diversion.  
*ALWAYS ALL* is displayed with the target extension or extension group number. The asterisk has been removed.
7. Press **SuperKey**.

## Divert on No Answer or Busy

This feature allows you to divert your calls to a nominated extension or extension group when you are busy on another call or you are unable to answer the call. If you always divert your calls to the same extension or extension group, you can program the **DIVERT ON NO ANSWER OR BUSY** key with this number. Alternatively, you can program the **DIVERT ON NO ANSWER OR BUSY** key without specifying a destination number, which means that you must dial an extension or extension group number each time you want to divert your calls. You can set up a number of **DIVERT ON NO ANSWER OR BUSY** keys on your extension, each holding a different extension or extension group number.

This feature can be set up using Call Divert under **SuperKey** and does not have to be programmed under a personal key. Refer to the operation described below.

### PROGRAMMING

1. Press **SuperKey**.
2. Press **#** repeatedly until PERSONAL KEYS? is displayed.
3. Press **\***.
4. Press the key to be programmed.  
*If a feature is already stored under the selected key, the existing feature is displayed with the option to change or clear the key.*
5. Press the **\*** to change the feature under the selected key.
6. Press **#** repeatedly to scroll down the list of available features until CALL DIVERT? is displayed.
7. Press **\*** to select this option.
8. Press **#** repeatedly until NA/B ALL is displayed.
9. Press **\*** at the NA/B ALL prompt to divert all your calls to another extension or extension group when you are busy on another call or away from your desk.  
*At this point, you can choose to program the key with or without a destination extension or extension group.*
10. Either, dial an extension number or extension group number, followed by **#** to save the dialled number.
11. Alternatively, press **\*** to divert your calls to an extension or **#** to divert your calls to an extension group.  
*When the key is pressed, you must dial an extension number or extension group number before the diversion is active.*

## OPERATION

**Note:** If you activate a diversion using **SuperKey**, and a diversion is active via a programmed **DIVERT ON NO ANSWER OR BUSY** key, the current diversion is overridden, and vice versa.

### Diverting your calls using SuperKey

To divert your calls to another extension or extension group when your extension is busy or you are unable to answer the call using SuperKey:

1. Press **SuperKey**.  
*CALL DIVERT? is displayed.*
2. Press \* to select the feature.
3. Press # repeatedly until NA/B ALL is displayed.
4. Press \* to display the stored target extension number or extension group number.  
*If programmed, NA/B ALL is displayed along with a target extension number or extension group number.*  
*If a target extension number or extension group number is displayed prefixed with an asterisk, it indicates that divert is already active.*

*If a target extension number or extension group number has not been programmed, you are prompted to dial an extension number:*

5. Press \* to change the stored number.
6. At the TO: prompt, dial the extension number you wish to divert your calls to.  
*If you make a mistake when dialling the extension number, press \* to remove the incorrect digits.*
7. Press \* to save the extension number.  
*If you dial an invalid extension number, the system will not allow you to save the extension number.*

*If a target extension number or extension group number has been programmed:*

8. Press \* to change the stored number.
9. Press # to turn on the diversion.  
*NA/B ALL is displayed with the target extension or extension group number and an asterisk. The asterisk indicates that the diversion is now active.*
10. Press **SuperKey**.  
*When you lift your handset, you hear interrupted dial tone indicating that you are diverting your calls.*

### Diverting your calls using a programmed key

To divert your calls to another extension when your extension is busy or you are unable to answer the call using a key programmed with a destination extension or extension group number:

- Press a **DIVERT ON NO ANSWER OR BUSY** key.  
*The associated **DIVERT ON NO ANSWER OR BUSY** key lights solid red. When you lift your handset, you hear interrupted dial tone indicating that you are diverting your calls.*

To divert your calls to another extension or extension group using a key which does not have an extension or extension group programmed:

1. Press a **DIVERT ON NO ANSWER OR BUSY** key.
2. Dial an extension or extension group number, or press a **DSS/BLF** or **EXTENSION GROUP** key.  
*The associated **DIVERT ON NO ANSWER OR BUSY** key lights solid red. When you lift your handset, you hear interrupted dial tone indicating that you are diverting your calls.*



## Diverting your calls using the feature access code

To divert your calls using a feature access code:

1. Dial one of the following codes:
  - **620** - Divert No Answer/Busy to an Extension
  - **619** - Divert No Answer/Busy to an Extension Group
2. Dial an extension or extension group number, or press a **DSS/BLF** or an **EXTENSION GROUP** key.  
*When you lift your handset, you hear interrupted dial tone indicating that you are diverting your calls.*

## Cancelling

To cancel a diversion using SuperKey:

1. Press **SuperKey**.  
*CALL DIVERT? is displayed.*
2. Press \* to select the feature.  
*ALWAYS is displayed.*
3. Press \* to select the feature.  
*ALWAYS ALL is displayed.*
4. Press # repeatedly until NA/B is displayed.
5. Press \* to select the feature.  
*NA/B ALL is displayed.*
6. Press \*.  
*NA/B ALL is displayed along with a pre-defined target extension number or extension group number and an asterisk.*
7. Press \* to change the diversion.
8. Press # to turn off the diversion.  
*NA/B ALL is displayed with the target extension or extension group number. The asterisk has been removed.*
9. Press **SuperKey**.

To cancel a diversion:

- Press the active **DIVERT ALL CALLS** key or dial the Cancel Divert feature access code, **617**.  
*If you have a programmed key, the key extinguishes.*

## Do Not Disturb (DND)

When an extension user calls your extension while Do Not Disturb is active, they hear busy tone and a message similar to the following is displayed on their LCD: EXT xxxx DND. This feature disables your extension's Ringer. External calls that are usually presented at your extension under a personal key, for example, LINE key and **ANSWER EXTERNAL CALL** key, continue to be presented; the associated key flashes with ringing cadence, however, your extension does not ring. Answer the call by pressing the flashing personal key.

When Do Not Disturb is active at your extension, you hear interrupted dial tone, and if programmed, your **DO NOT DISTURB** key is lit. When this feature is active, your extension also ignores any paging extension calls.

### PROGRAMMING

**Note:** This feature can be programmed under a personal key or activated by dialling the feature access code.

Program the **DO NOT DISTURB** key as described under **Programming a Personal Key**.

### OPERATION

*To activate Do Not Disturb:*

- Press the **DO NOT DISTURB** key or dial the Do Not Disturb feature access code, **607**.  
*DO NOT DISTURB is displayed on your extension, and if programmed, your DO NOT DISTURB key lights solid orange, regardless of how you invoked the feature.*  
*When you press **Intercom** or lift your handset you hear interrupted dial tone indicating that the feature is active.*

*To de-activate Do Not Disturb:*

- Press the **DO NOT DISTURB** key again or dial the Do Not Disturb feature access code, **607**.  
*If programmed, your DO NOT DISTURB key extinguishes, and your LCD returns to normal.*  
*Normal dial tone returns.*

## Doorphone Operation

This feature allows one extension on the system to answer the Doorphone Intercom. When someone wants to enter, your extension rings, the associated Doorphone **DSS/BLF** key flashes and the number of the Doorphone extension is displayed. After answering the call, you are connected to the Doorphone Intercom. Press the **DOOR OPEN** key to open the door.

### Notes:

1. A **DOOR OPEN** key can only be programmed on the extension which is set up to answer the Doorphone Intercom.
2. If you are speaking to an external caller when a Doorphone call is presented, you may place the current call on hold.
3. Doorphone calls override Do Not Disturb.
4. The door may be opened at any time by pressing the **DOOR OPEN** key.

### PROGRAMMING

Program the **DOOR OPEN** key as described under *Programming a Personal Key*.

### OPERATION

**Note:** You must have a pre-programmed **DOOR OPEN** key set up on your extension to use this feature.

*To answer a call from the Doorphone and open the door:*

1. The caller presses the call button.  
*The Door Answer extension rings, the associated **DSS/BLF** key flashes orange and the Doorphone extension number is displayed.*
2. Answer the call.  
*The associated **DSS/BLF** key lights solid orange and the LCD indicates that the call has been answered.*
3. Press the **DOOR OPEN** key to unlock the door.  
*The associated **DSS/BLF** key extinguishes.*

## Emergency 9-9-9 Calls

You can contact 911 emergency services from any extension in the system that has access to an outside line.

### OPERATION

1. Access a line, either using the out access digit or press a **LINE** or **LINE GROUP** key.  
*You hear external dial tone.*
2. Dial 999.

## Exclusive Hold

If you do not have dedicated **LINE** or **DSS/BLF** keys programmed on your extension, this type of hold allows you to place a single party on hold using **Hold** or the **EXCLUSIVE HOLD** key. If you do have dedicated keys, you can place a number of parties on Exclusive Hold. The dedicated **LINE** or **DSS/BLF** key flashes red with held cadence indicating that a call is currently being held and can be retrieved by pressing this key.

### PROGRAMMING

Program the **EXCLUSIVE HOLD** key as described under **Programming a Personal Key**.

### OPERATION

The following paragraphs describe how to use Exclusive Hold depending on what keys you have set up at your extension.

#### Using Exclusive Hold if you do NOT have dedicated DSS/BLF or LINE keys

*To place a call on hold to make an enquiry call or answer another call:*

- Whilst in conversation with an established call, press **Hold** or the **EXCLUSIVE HOLD** key. *The current call is placed on hold, and the caller hears silence, tone or music on hold. If programmed, the **EXCLUSIVE HOLD** key flashes red with held cadence.*

*To retrieve a call from hold:*

- Press **Hold** or the **EXCLUSIVE HOLD** key. *You are re-connected to the held party.*

#### Using Exclusive Hold if you do HAVE dedicated DSS/BLF or LINE keys

*To place a call on hold to make an enquiry call or answer another call:*

- Whilst in conversation with an established call, press **Hold** or the **EXCLUSIVE HOLD** key. *The current call is placed on hold, and the caller hears silence, tone or music on hold. If programmed, the **EXCLUSIVE HOLD** key flashes red with held cadence.*

*To retrieve a call from hold:*

- Press the flashing **DSS/BLF** or **LINE** key. *You are re-connected to the held party.*

## Extension Paging

This feature allows you to turn on the loudspeaker at another extension, or at a number of extensions, and broadcast a message to these extension users. You can use Extension paging to page

- another extension user;
- all extension users in an extension group;
- all extension users on the system.

**Note:** You cannot page your own extension group.

### PROGRAMMING

**Note:** You can choose to save an **EXTENSION PAGING** key with or without specifying the target extension(s).

Program an **EXTENSION PAGING** key as described under *Programming a Personal Key*.

### OPERATION

*To page an extension, extension group or all extensions on the system if you have a dedicated EXTENSION PAGING key:*

1. Lift your handset.
2. Press the **EXTENSION PAGING** key.  
*Your **EXTENSION PAGING** key lights solid orange and you hear a short burst of tone.*
3. Make the announcement.
4. Replace your handset.  
*Your **EXTENSION PAGING** key extinguishes.*

*To page an extension or extension group if you do NOT have a dedicated EXTENSION PAGING key:*

1. Lift your handset.
2. Press the **EXTENSION PAGING** key or dial the **EXTENSION PAGING** feature access code, **644**.
3. Dial the required target extension or extension group or press a **DSS/BLF** or EXTENSION GROUP key.  
*Your **EXTENSION PAGING** key lights solid orange and you hear a short burst of tone. A message similar to the following is displayed: SPEAK EXT xxxx, where xxxx is the extension number you have paged.*
4. Make the announcement.
5. Replace your handset.

*To page all extensions on the system if you do NOT have a dedicated EXTENSION PAGING key:*

1. Lift your handset.
2. Press the **EXTENSION PAGING** key or dial the Extension Paging feature access code, **644**.
3. Dial \*.  
*Your **EXTENSION PAGING** key lights solid orange and you hear a short burst of tone.*
4. Make the announcement.
5. Replace your handset.

## External Call Waiting Tone

This feature enables or disables Call Waiting tone on your extension. When enabled, a short burst of tone is generated when an external call arrives at your extension and your extension is busy.

When Call Waiting tone is heard, you can leave the incoming call unanswered until you have finished the current call, or place the current call on hold and answer the new call.

### OPERATION

*To enable Call Waiting tone:*

1. Dial the Call Waiting tone feature access code, **687**.
2. Press 1.
3. Replace your handset.

*To disable Call Waiting tone:*

1. Dial the Call Waiting tone feature access code, **687**.
2. Press 0.
3. Replace your handset.

## External Divert

This feature allows you to divert your incoming calls to an external destination, for example, a cellular phone or your home number.

This feature can be set up using Call Divert under **SuperKey** and does not have to be programmed under a personal key. Refer to the operation described below.

### Notes:

1. This feature is not available at all extensions, please contact your Administrator if you require this feature.
2. Invoking External Divert cancels any active internal diversions, and vice versa.
3. You cannot store the target external number under a personal key programmed with the External Divert feature.

## PROGRAMMING

Program a **EXTERNAL DIVERT** key as described under *Programming a Personal Key*.

## OPERATION

### Notes:

1. If you activate diverting using **SuperKey**, and a diversion is active via a programmed key, the current diversion is overridden, and vice versa.
2. You cannot divert your calls to an external destination if you are diverting to an internal extension, or vice versa.

## Diverting your calls using SuperKey

To divert all your calls to an external destination using SuperKey:

1. Press **SuperKey**.
2. *CALL DIVERT?* is displayed.
3. Press \* to select this feature.
4. Press \* to review the target number, if programmed.  
*If programmed, R.A is displayed along with a target external number.  
If a target external number is displayed prefixed with an asterisk, it indicates that a diversion is already active.*

*If a target external number has not been programmed, you are prompted to dial an external number:*

5. Press \* to program a target external number.
6. At the TO: prompt, dial the external number (including the line access number) you wish to divert your calls to.  
*If you make a mistake when dialling the external number, press \* to remove the incorrect digits.*
7. Press \* to save the external number.

*If a target external number has been programmed:*

8. Press \* to change the displayed external number.
9. Press # to save the external number.  
*R.A is displayed with the target external number and an asterisk. The asterisk indicates that the diversion is now active.*  
**Note:** *If you have another type of diversion setup and active via **SuperKey**, for example, Divert on No Answer/Busy, Follow Me or External Divert, the next available diversion type is selected.*
10. Press **SuperKey** to complete the programming.  
*When you lift your handset, you hear interrupted dial tone indicating that you are diverting your calls.*

## Diverting your calls using a programmed key

To divert all your calls to an external destination using the EXTERNAL DIVERT key:

1. Press the **EXTERNAL DIVERT** key.
2. Dial the external number (including the line access number) you wish to divert your calls to.  
*The associated **EXTERNAL DIVERT** key lights solid orange. When you lift your handset, you hear interrupted dial tone indicating that you are diverting your calls.*

## Diverting your calls using the feature access code

To divert all your calls to an external destination using the External Divert feature access code:

1. Dial the External Divert feature access code, **688**.
2. Dial the external number (including the line access number) you wish to divert your calls to.  
*When you lift your handset, you hear interrupted dial tone indicating that you are diverting your calls.*

## Diverting your calls to the last External Call Divert destination dialed

To divert your calls to the destination you dialed when you last used External Call Divert:

## Diverting your calls to the last externally-dialed number

To divert your calls to the last externally-dialed number:

1. While your extension is idle, press the **EXTERNAL DIVERT** key, or dial the External Divert feature access code, **688**.
2. Press # to complete the digit sequence.  
**Note:** Pressing **Hold** during the sequence indicates a pause for dial tone.



## **Cancelling**

*To cancel External Diverting using SuperKey:*

1. Press **SuperKey**.
2. Press **#** to scroll down the list until CALL DIVERT? is displayed.
3. Press **\*** to select the feature.
4. Press **#** until REMOTE ALWAYS is displayed.
5. Press **\*** to display the target extension number.  
*R.A is displayed with the external number and an asterisk.*
6. Press **\*** to change the programmed extension number.
7. Press **#** to turn off the diverting.  
*R.A is displayed with the target external number. The asterisk has been removed.*
8. Press **SuperKey**.

*To cancel External Diverting using the feature key or access code:*

- Press the **EXTERNAL DIVERT** key or dial the Cancel Call Divert feature access code, **617**.

## Follow Me

This feature allows you to temporarily divert your calls to another extension before leaving to work at another desk; your calls follow you to the other desk. If you always divert your calls to the same extension, you can program a **FOLLOW ME** key with this extension number. Alternatively, you can program the **FOLLOW ME** key without specifying a destination number, which means that you must dial an extension number each time you want to divert your calls. You can set up a number of **FOLLOW ME** keys on your extension, each holding a different destination extension number.

If you do not dial a target extension number when setting up this feature, the feature is enabled but is not fully active, this means that another extension can "pull" calls from your extension at a later time by using the Follow Me (I'm Here) feature.

This feature can be set up using **CALL DIVERT** under **SuperKey** and does not have to be programmed under a personal key. Refer to the operation described below.

### PROGRAMMING

1. Press **SuperKey**.
2. Press **#** repeatedly until PERSONAL KEYS? is displayed.
3. Press **\*** to select this option.
4. Press the key to be programmed.
5. Press **\*** to change the feature stored under the selected key.
6. Press **#** repeatedly to scroll down the list of available features until CALL DIVERT? is displayed.
7. Press **\*** to select this option.
8. Press **#** repeatedly until **FOLLOW ME** is displayed.
9. Press **\***.  
*At this point, you can choose to program the key with or without a destination extension number.*
10. Either press **#** to program a key without a destination extension, or dial the extension number of the diverting extension at the TO: prompt, followed by **#** to save the number.
11. Press **SuperKey** to complete the programming.

## OPERATION

**Note:** If you activate the diversion using **SuperKey**, and a diversion is active via a programmed **FOLLOW ME** key, the current diversion is overridden, and vice versa.

### Setting up Follow Me using SuperKey

*To allow your calls to follow you to another extension using SuperKey:*

1. Press **SuperKey**.
2. Press **#** to scroll down the list until CALL DIVERT? is displayed.
3. Press **\*** to select the feature.
4. Press **#** until **FOLLOW ME** is displayed.
5. Press **\*** to review the target number, if programmed.  
*If programmed, FOLLOW ME is displayed along with a target extension number.  
If a target extension number is displayed prefixed with an asterisk, it indicates that a diversion is already active.*

*If a target extension number has not been programmed, you are prompted to dial an extension number:*

6. Press **\*** to program an extension number.
7. At the TO: prompt, dial the extension number you wish to divert your calls to.  
*If you make a mistake when dialling the extension number, press **\*** to remove the incorrect digits.*
8. Press **#** to save the extension number.  
*If you dial an invalid extension number, the system will not allow you to save the extension number.*
9. Press **\*** to activate the diversion to the displayed extension number.
10. Press **#** to turn on the the diversion.  
*FOLLOW ME is displayed along with the target extension number and an asterisk. The asterisks indicates that the diversion is now active.*
11. Press **SuperKey**.  
*When you lift your handset, you hear interrupted dial tone indicating that your calls are being diverted.*

### Setting up Follow Me using a programmed key

*To enable your calls to follow you to another extension using a key programmed with the destination extension number:*

- From your extension, press the **FOLLOW ME** key.  
*The **FOLLOW ME** key lights solid orange and when you lift your handset you hear interrupted dial tone indicating that your calls are being diverted.*

*To enable your calls to follow you to another extension using a FOLLOW ME key which does not have a destination extension number programmed:*

1. From your extension, press the **FOLLOW ME** key.
2. Dial the extension number or press a **DSS/BLF** key where you wish to divert your calls.  
*The **FOLLOW ME** key lights solid orange and when you lift your handset you hear interrupted dial tone indicating that your calls are being diverted.*

## Setting up Follow Me using the feature access code

To enable your calls to follow you to another extension using the Follow Me feature access code:

1. From your extension, dial the Follow Me feature access code, **641**.
2. Dial the extension number or press the **DSS/BLF** key where you wish to divert your calls.  
*When you lift your handset, you hear interrupted dial tone indicating that your calls are being diverted.*

## Enabling Follow Me

To enable, but not activate, Follow Me from your usual extension:

- Press a **FOLLOW ME** key (which does not hold an extension number) or dial the Follow Me feature access code, **641**.  
*Your calls are not diverted until another extension invokes the Follow Me (I'm Here) feature.*

## Cancelling Follow Me from your usual extension

To cancel Follow Me via SuperKey:

1. Press **SuperKey**.
2. Press **#** to scroll down the list until CALL DIVERT? is displayed.
3. Press **\*** to select the feature.
4. Press **#** repeatedly until **FOLLOW ME** is displayed.
5. Press the **\*** to display the programmed target extension number.  
***FOLLOW ME** is displayed along with a pre-defined target extension number and an asterisk.*
6. Press **\*** to change the programmed extension number.
7. Press **#** to turn off the the diversion.  
***FOLLOW ME** is displayed with the target extension number. The asterisk has been removed.*
8. Press **SuperKey**.

To cancel from your usual extension using the FOLLOW ME key:

- Press the **FOLLOW ME** key.  
*The key extinguishes to indicate that the feature is disabled.*

To cancel from your usual extension using the feature access code:

1. Lift your handset.  
*You hear interrupted dial tone.*
2. Dial the Cancel Follow Me feature access code, **640**.  
*You hear normal dial tone; your calls are no longer diverted to the nominated extension.*

## Cancelling Follow Me from the remote extension

To cancel Follow Me from the remote extension:

1. Dial the Cancel Follow Me feature access code, **640**.
2. Dial your usual extension number.  
*This cancels call diversions at the remote extension (if previously enabled).*
3. Repeat the steps to cancel Follow Me.

## Follow Me (I'm Here)

This feature enables you to "pull" calls from your usual extension to the extension at which you are currently working. You can use this feature to ensure that your calls continue to follow you when you are working at various desks within your office.

**Note:** A Follow Me (I'm Here) request is not allowed if the "pulled-from" extension does not have the Follow Me feature enabled or active.

### PROGRAMMING

Program a **FOLLOW ME** key without a destination extension number as described under *Follow Me*.

#### Enabling

*To enable Follow Me from your usual extension:*

- Press a **FOLLOW ME** key which does not hold an extension number or dial the Follow Me feature access code, **641**.

#### Activating

*To activate from a remote extension:*

1. Dial the Follow Me (I'm Here) feature access code, **642**.
2. Dial your usual extension number.  
*Your calls are diverted to the new extension.*  
*When you move to another extension repeat the above steps and your calls will follow you.*

#### Cancelling from the remote extension

*To cancel from the remote extension:*

1. Dial **640**.
2. Dial your usual extension number.

#### Cancelling from your usual extension

*To cancel from your usual extension using SuperKey:*

1. Press **SuperKey**.  
*CALL DIVERT? is displayed.*
2. Press \* to select the feature.
3. Press # repeatedly until FOLLOW ME is displayed.
4. Press \* to display the target extension number.  
*FOLLOW ME is displayed along with a pre-defined target extension number and an asterisk.*
5. Press \* to change the displayed extension number.
6. Press # to turn off the diversion.  
*FOLLOW ME is displayed with the target extension number. The asterisk has been removed.*
7. Press **SuperKey**.

*To cancel from your usual extension:*

- Press the FOLLOW ME key once to de-activate or twice to cancel all Follow Me requests.  
*Calls are received normally at your usual extension.*

## Group Call Pick-up

This feature allows you to pick up an incoming call which is ringing at another extension in your pick-up group. If there is more than one extension ringing in your pick-up group, you answer the call with the highest priority, that is, an external call takes priority over an internal call.

A pick-up group is a group of extensions which, when one extension rings, other extension users in the group can pick-up the call if, for example, the extension user is absent. Refer to your Administrator if you feel that you need to be placed in a certain group, for example, a pick-up group for your department.

You can also pick up a call ringing at another extension which is not in your pick-up group, for more information refer to *Directed Call Pick-up*.

**Note:** Your Administrator can set up the system so that a single-digit can be used to pick-up the call instead of using the three-digit access code. Contact your Administrator for a list of single-digit access codes.

### PROGRAMMING

Program a **GROUP PICK-UP** key as described under *Programming an Extension Group Key*.

### OPERATION

*To answer a call that is ringing at another extension in your pick-up group:*

1. Lift your handset.
2. Press the **GROUP PICK-UP** key or dial the single-digit access code, 8 (system default), or dial the Group Call Pick-up feature access code, **666**.

*You are connected to the caller of the ringing extension.*

## Group Listen

During a handset call, this feature turns on your extension's loudspeaker to allow others nearby to listen to your current call whilst your handset microphone remains on allowing you to speak to the other person.

### PROGRAMMING

**Note:** You must have a pre-programmed **GROUP LISTEN** key set up on your extension to use this feature.

Program a **GROUP LISTEN** key as described under *Programming a Personal Key*.

### OPERATION

*To activate your extension's loudspeaker during a call:*

- Press the **GROUP LISTEN** key.  
*Your **GROUP LISTEN** key lights solid orange when your loudspeaker is enabled and the following message is displayed: **GROUP LISTEN***

*To de-activate your extension's loudspeaker:*

- Press the **GROUP LISTEN** key again.  
*Your **GROUP LISTEN** key light extinguishes and your LCD returns to normal.*

## Handsfree Operation

Handsfree operation allows you to answer and make calls without lifting your handset. If you wish to enter into a two-way conversation you must lift your handset.

**Note:** Full handsfree operation is available on Mitel Networks 5215 IP Phones and 5140 IP Appliances.

### OPERATION

*To use handsfree operation to make calls:*

1. Press **Intercom**, or press a **DSS/BLF** key or **LINE** key, or dial the external or internal number.
2. Lift your handset.
3. Hold conversation as usual.

## Immediate Divert

With this feature, a single key press will divert all calls currently ringing at your extension to another internal destination, for example, voice mail. You specify the destination when programming the feature to a key.

### PROGRAMMING

Program an **IMMEDIATE DIVERT** key as described under *Programming a Personal Key*.

### OPERATION

While a call is ringing or when you hear Call Waiting tone during a call:

- Press the **IMMEDIATE DIVERT** key.  
*The **IMMEDIATE DIVERT** key lights briefly and ringing stops. Continuous ringing indicates that diversion is disallowed.*

## Intrude

This feature allows you to enter an established call and speak to the parties involved; your entry is announced by a warning tone that all parties can hear.

The availability of this feature depends on the "Intrude Priority" assigned to your extension. Check with your Administrator.

*You cannot intrude on an extension which has:*

- SUPER intrude priority;
- a higher intrude priority than allocated at your own extension;
- a Three-Party Conference call in progress;
- Do Not Disturb activated.

**Note:** Your Administrator can set up the system so that a single-digit can be used to intrude into an established call instead of using the three-digit access code. Contact your Administrator for a list of single-digit access codes.

## PROGRAMMING

Program an **INTRUDE** key as described under *Programming a Personal Key*.

## OPERATION

### Intruding on an Established Conversation

*You attempt to call extension "A", but "A" is in conversation with party "B" and you hear busy tone:*

- Press the **INTRUDE** key or dial the single-digit Intrude code.  
*Parties "A" and "B" hear a short warning tone before you are connected. During the intrusion all parties hear a warning tone and a message similar to the following is displayed on all extensions involved in the intrusion: EXT. xxxx INTRUSION.*

### Speaking to Party "A" only

*After intruding into a conversation:*

1. Press the **INTRUDE** key again or dial the single-digit Intrude code.  
*You are connected to Party "A". Party "B" is placed on hold, and if set up, Party "B" hears music on hold or tone.  
If programmed, your **INTRUDE** key extinguishes, Intrude tone is removed, and your LCD returns to normal.*
2. Or, if you have a **DSS/BLF** key for Party "A", press Party "A"'s **DSS/BLF** key.  
*You are connected to Party "A". Party "B" is placed on hold, and if set up, Party "B" hears music on hold or tone.  
If programmed, your **INTRUDE** key extinguishes, Intrude tone is removed, and your LCD returns to normal.*



## Speaking to Party "B" only

*After intruding into a conversation:*

- If you have a **DSS/BLF** or **LINE** key for Party "B", press this key.  
*You are connected to Party "B". Party "A" is placed on hold, and if set up, Party "A" hears music on hold or tone.*

*If programmed, your **INTRUDE** key extinguishes, Intrude tone is removed, and your LCD returns to normal.*

**Note:** You cannot use the **INTRUDE** key to reconnect to the two parties after the call has been "split", however, if you wish to talk to both parties again, you must set up a three-party conference. Refer to *Three-Party Conference* for more information on this feature.

## Withdrawing from an intrusion

*To exit, leaving Parties "A" and "B" in private conversation:*

- Replace your handset.  
*Parties "A" and "B" are reconnected in a normal two-party conversation. Intrude tone is no longer heard.*

*If you placed a call on Exclusive Hold before using the Intrude feature*

- Press **Hold** or press the flashing **LINE** or **DSS/BLF** key.  
*Parties "A" and "B" are reconnected in a normal two-party conversation; you are reconnected to the held caller.*

*If a flashing key indicates that a call is incoming to your extension*

- Press the flashing **LINE** or **DSS/BLF** key.  
*Parties "A" and "B" are reconnected in a normal two-party conversation; you are connected to the incoming call.*

## Key Click Control

This feature enables you to silence the tone (click) you hear when you press a key on the keypad.

### OPERATION

*To enable or disable key clicks:*

- Whilst your extension is idle, dial **663** followed 1 to enable or 0 to disable the clicks.

## Last Call Cost Display

This feature enables the cost of the last external call that was made from your extension to be displayed on your extension's LCD.

The cost of the current call is dynamically displayed during the call.

**Note:** For analogue lines, the local exchange must provide meter pulses for the call cost to be displayed. Refer to your Administrator to confirm if your system supports this feature.

### PROGRAMMING

Program a **LAST CALL COST** key as described under *Programming a Personal Key*.

### OPERATION

*To display hear the cost of the last external call:*

- Whilst your extension is idle, press the **CALL COST** key or dial the Last Call Cost feature access code, **664**.  
*The cost of the last call is displayed on your LCD in Sterling.*

## Last Call Duration Display

This feature enables the duration of the last external call that was made from your extension to be displayed on your extension's LCD.

The duration of the current call is dynamically displayed during the call.

### PROGRAMMING

Program a **CALL DURATION** key as described under *Programming a Personal Key*.

### OPERATION

*To display the duration of the last external call:*

- Whilst your extension is idle, press the **CALL DURATION** key or dial the Last Call Duration feature access code, **663**.  
*The duration of the last call is displayed on your LCD in hours, minutes and seconds*

## Last Number Redial

This feature enables you to redial the last external number dialled from your extension.

Also refer to *Redial List* which allows you to redial external numbers from a stored list.

**Notes:** You cannot redial an external number if it was called via a Personal Speed Call.

### OPERATION

*To redial the last external number:*

- Press **Shift** twice or dial the Last Number Redial feature access code, **600**.

## List of Calls

This feature lists the ten most recent, incoming calls to your extension whether answered or not. Only incoming external calls are listed. Calls from the same number count as one call. The options available to you are:



**Note:** Only calls with Calling Line ID information appear in the List of Calls.

- Dial - to call the displayed entry;
- Date/Time - displays the date and time of the call and how many times that number has called;
- Edit - to edit the currently displayed entry;
- Delete - to delete currently displayed entry;
- Exit - returns you to the previous menu.

**Note:** Only calls with Calling Line ID information appear in the List of Calls.

### OPERATION

*To display a list of the last ten incoming calls:*

1. Press **SuperKey**.  
*PHONEBOOK? is displayed.*
2. Press **#** until REDIAL LIST is displayed.
3. Press **\*** to select this option.  
*The most recent incoming call is displayed.*
4. Use  and  to scroll through the list of callers.
5. When you have selected the required entry, press **#** to move to the desired option, as shown above, or press the **\*** to dial the selected entry.

## Loudspeaker Paging

This feature allows you to make an announcement via the loudspeaker system.

### Notes:

1. Check with your Administrator that your system is set up to make announcements via the loudspeaker system.
2. You may also make announcements via an extension's loudspeaker, for more information refer to *Extension Paging*.

### OPERATION

**Note:** Contact your Administrator to check that your extension has the correct permissions to make an announcement.

*To make an announcement via the loudspeaker system:*

1. Lift your handset.
2. Enter the Loudspeaker Paging extension number, or press the Loudspeaker Paging **DSS/BLF** key.
3. Make the announcement.
4. Replace your handset.

## Manager/Secretary (Absent/Present) Operation

This feature enables your extension to be nominated as a "Secretary" or "Manager" extension. A Secretary extension can serve one, or more Manager extensions. Each extension must have an **ABSENT/PRESENT** key and the Secretary extension must also have a **CALLS FOR** key. If a Secretary has only one Manager, the Manager extension should also have a **CALLS FOR** key programmed with the Secretary's extension number.

When a Manager presses the **ABSENT/PRESENT** key, all calls are diverted to the associated Secretary. A Secretary answers calls ringing at a Manager's extension by pressing the lit **CALLS FOR** key assigned to that Manager. A Secretary can also remotely set the 'Absent/Present' status of a Manager's extension by pressing the relevant **CALLS FOR** key.

If a Secretary has only one Manager and either extension is placed into the Absent state, all calls are transferred to the other extension. If both extensions are in the Absent state, calls are diverted to the System Backstop. When absent, a Secretary who serves several Managers can also use the Absent/Present feature to divert calls to the System Backstop.

**Note:** Manager/Secretary working can only be set up from an Administrator Extension. Contact your Administrator if you require this feature.

## PROGRAMMING

**Note:** You must have a pre-programmed **ABSENT/PRESENT** key set up on your extension to use this feature.

Program an **ABSENT/PRESENT** key as described under *Programming a Personal Key*. Program a **CALLS FOR** key as described under *Calls For*.

## OPERATION

*If you are a Manager and wish to divert your calls to your Secretary's extension:*

- Press the **ABSENT/PRESENT** key.  
*Your **ABSENT/PRESENT** key lights solid orange indicating that you are diverting your calls. Repeatedly pressing the **ABSENT/PRESENT** key toggles between placing your extension in absent or present mode.*

*If you are a Secretary and wish to divert your calls to your Manager's extension:*

**Note:** This is only possible if you have only ONE Manager.

- Press the **ABSENT/PRESENT** key.  
*Your **ABSENT/PRESENT** key lights solid orange indicating that you are diverting your calls.*

*If you are a Secretary and wish to divert your calls to the System Backstop when you only have ONE Manager:*

- Both yourself and your Manager press your **ABSENT/PRESENT** keys.  
*All calls are re-routed to the System Backstop.*

*If you are a Secretary and wish to divert your calls to the System Backstop when you serve more than one Manager:*

- Press your **ABSENT/PRESENT** key.  
*All calls are re-routed to the System Backstop.*

*To toggle the Absent/Present state of a Manager's extension:*

- Press the **CALLS FOR** key associated with the Manager's extension.  
*Your **CALLS FOR** key and your Manager's **ABSENT/PRESENT** key light or extinguish, as appropriate.*

## Message Waiting

When you call another extension and your call is unanswered or the called extension is busy, you can leave a message waiting indication to alert the user to return your call. The called extension user is informed of the message waiting indication by their Message Indicator flashing and their LCD displays MESSAGE WAITING. The Message Indicator and display message at the target extension are removed when a connection is established between you and the called extension.

You can also leave a message waiting indication at another extension directly, that is, without dialling the extension number, using the Directed Message Waiting feature access code whilst your extension is idle.

**Note:** You cannot leave a message waiting indicator at an extension which already has a message waiting from another extension user; you hear unobtainable tone.

If you have left a message waiting indication at another user's extension and wish to cancel it, you can do so via the pre-programmed **CANCEL MESSAGE** key or feature access code **628**. Refer to *Cancelling a Message Waiting Indication* below.

### PROGRAMMING

You can program a **CANCEL MESSAGE** key with or without the inclusion of an extension number. Program a **CANCEL MESSAGE** key as described under *Programming a Personal Key*.

### OPERATION

#### Leaving a Message Waiting Indication

*To leave a message waiting indication after calling an extension which is unanswered or busy:*

- Whilst listening to ringing or busy tone, press **Message**.

*To leave a message waiting indication at an extension without calling the extension:*

1. Whilst your extension is idle, dial the Directed Message Waiting feature access code, **673**.
2. Enter the extension number of the target extension, or press the relevant **DSS/BLF** key.

#### Responding to a Message Waiting Indication

If your extension's Message Indicator is flashing and MESSAGE WAITING is displayed on your LCD:

- Press **Message** or dial the Message Waiting feature access code, **643**.  
*If the message waiting indication is from another extension user, the originating extension of the message waiting indicator is called. If you have a message waiting indication from the Voicemail system, the Voicemail extension is called.*

**Note:** If you have two message waiting indications left at your extension, that is, one to call the Voicemail system and the other from another extension user, the Voicemail system is always called first.

## **Cancelling a Message Waiting Indication**

**Note:** A message waiting indication can only be cancelled from your extension.

*To cancel a Message Waiting indication using a CANCEL MESSAGE key which does not include an extension number:*

1. Press the **CANCEL MESSAGE** key or dial the Cancel Message Waiting feature access code, **628**.
2. Dial the extension number of the called extension or press the relevant **DSS/BLF** key.

*To cancel a Message Waiting indication using a CANCEL MESSAGE key which holds an extension number:*

- Press the **CANCEL MESSAGE** key.

*To cancel a Message Waiting indication using the Cancel Message feature access code:*

1. Dial the Cancel Message feature access code, **628**.
2. Dial the extension number of the called extension or press the relevant **DSS/BLF** key.

## Messaging

You can program your extension to display a message at a calling extension; the message remains on the calling extension's LCD for the duration of ringing and is cleared when the caller hangs up or you answer the call.

*Table 5, Advisory Messages*

<b>Msg. No.</b>	<b>Message</b>
1	AWAY SICK
2	AWAY ON HOLIDAY
3	BACK TOMORROW / MONDAY ... SUNDAY
4	BACK AM/BY MIDDAY/11AM ... 1AM*
5	GONE TO LUNCH
6	BACK PM/BY 1PM, 2PM ... MIDNIGHT*
7	GONE HOME
8	PLEASE CALL BACK
9	BUSY IN MEETING
0	NO CALLS PLEASE
*	BACK SOON

\* Repeated presses of this key steps through the available displays.

### OPERATION

*To turn Messaging on:*

1. Press **SuperKey**.
2. Press **#** repeatedly until ADVISORY MESSAGES? is displayed.
3. Press **\***.
4. Press the keypad key corresponding to the message that you wish to leave (refer to Table 5).
5. Press **\*** to select the message.

*MESSAGE TURNED ON is displayed indicating that your request has been successful, then the selected message is displayed on your extension.*

*To turn Messaging off:*

1. Press **SuperKey**.
2. Press **#** repeatedly until ADVISORY MESSAGES? is displayed.
3. Press **\*** to select this option.
4. Press the keypad key corresponding to the message that you wish to remove.
5. Press **\*** to remove the advisory message.

*The advisory message is removed from your extension's LCD.*



## MF (Multi-Frequency) Tone Dialling

If your system has loop disconnect signalling, you can still access services that require the use of dual tone multi-frequency tones, such as banking and voicemail systems.

Your Administrator can advise on the type of signalling in use on the system. The following procedure is not necessary for lines configured for multi-frequency (MF) signalling.

### OPERATION

1. Access a line, either using the out access digit or press a **LINE** or **LINE GROUP** key.  
*You hear external dial tone.*
2. Dial the required external number to access the service you require.  
*You hear ringing tone and an indication of the system answering.*
3. Press \*.  
*The signalling from your extension is now multi-frequency; all digits now dialed are received and acted upon by the called system.*
4. When the call is finished, replace you handset.  
*The signalling is now reset to its original setting.*

## Night Service Pick-up

The Night Service feature allows an Administrator to direct incoming external calls to an extension or a number of extensions which will be answered outside of normal working hours. There are two Night Service groups available, and an extension can be included in either or both groups. When either of the Night Service modes is active, the Night Service Pick-up feature allows you to pick up an incoming external call which is ringing at another extension in your Night Service Pick-up group.

**Note:** Your Administrator can set up the system so that a single-digit can be used to pick-up the call instead of using the three-digit access code. Contact your Administrator for a list of single-digit access codes.

### PROGRAMMING

Program a **NIGHT SERV PICKUP** key as described under *Programming a Personal Key*.

### OPERATION

*To answer a call that is ringing at another extension in your Night Service Pick-up group:*

- Press the **NIGHT SERVICE PICKUP** key, or dial the Call Pick-up single-digit access code (system default), 8, or dial the Night Service Pick-up feature access code, **696**.  
*You are connected to the caller of the ringing extension.*

## Personal Speed Calls

This feature allows you to save frequently-dialled external numbers under personal keys and keypad keys. A Personal Speed Call can be saved under a personal key as a primary or secondary feature.

A Personal Speed Call allocated to a personal key, which does not have another feature stored, is defined as being saved at the "primary" level. If a feature is allocated to the key at a later date, the Personal Speed Call moves to the "secondary" level. If a feature is already programmed to a personal key, the Personal Speed Call number is stored at the "secondary" level.

A Personal Speed Call stored under a personal key at the primary level is accessed by a single press of the personal key. If stored under a keypad key or under a personal key at the secondary level, it is accessed by pressing **Shift** followed by the desired keypad key or personal key.

### Notes:

1. You cannot store two Personal Speed Call numbers on the same personal key.
2. You cannot store Personal Speed Call numbers on a Programmable Key Module.
3. Your Administrator can set up the system to store up to 1000 external numbers which you can access via a four-digit access code or you can set up your extension to store a System Speed Call number under a personal key. Refer to *System Speed Call Numbers* for more information.
4. If you wish to store an extension number under a personal key, refer to *Programming a DSS/BLF key* for more information.

## PROGRAMMING

### Notes:

1. Ensure that you dial the line access digit plus the area code.
2. A pause for dial tone can be inserted in the stored number digit string by pressing Hold at the appropriate point. This causes the system to wait for dial tone before dialling the remaining digits. If required, you can insert multiple pauses.

*To program a Personal Speed Call number as a primary feature:*

1. Press **SuperKey**.
2. Press **#** until PERSONAL KEYS? is displayed.
3. Press **\*** to select this option.
4. Press the personal key under which the number is to be stored.  
*If a feature or speed dial number is already stored under the selected key, the feature or number is displayed with the option to change or erase the feature or number.*
5. Press **\*** to change the feature stored under the selected key.
6. Press **\*** to select this feature.
7. Dial the number that you wish to store.  
*At any time during the dialling sequence you can press **\*** to erase previously inserted digits.*
8. Press **#** to save the personal speed call number.
9. Press **SuperKey**.
10. Write the personal speed call number on the key label.

*To program a Personal Speed Call as a secondary feature:*

1. Press **SuperKey**.
2. Press **#** until PERSONAL KEYS? is displayed.
3. Press **\*** to select this option.
4. Press **Shift** followed by the personal key or keypad key under which the number is to be stored.  
*If a personal speed dial number is already stored under the selected key, the existing number is displayed with the option to change or erase the number.*
5. Press **\*** to change the feature stored under the selected key.
6. Press **#** until SPEED CALL is displayed.
7. Press **\*** to select this feature.
8. Dial the number that you wish to store. (Ensure that you dial the line access digit plus the area code for long distance numbers.)  
*At any time during the dialling sequence you can press \* key to erase previously inserted digits.*
9. Press **#** to save the personal speed call number.
10. Press **SuperKey**.
11. Write the personal speed call number on the key label or make a note of the keypad key under which the personal speed call is held.

*To store the last externally-dialed number:*

1. Press **SuperKey**.
2. Press **Shift**.
3. Press the personal key or keypad key to hold the Personal Speed Call.
4. Dial the number that you wish to store.
5. Press **Shift** twice.
6. Press **Superkey** twice.
7. Press **SuperKey** again to complete the operation
8. Write the personal speed call number on the key label or make a note of the keypad key under which the personal speed call is held.

## OPERATION

*To dial a number stored as a primary feature:*

- Press the personal key under which the stored number has been programmed.

*To dial a number stored as a secondary feature:*

1. Press **Shift**.
2. Press the personal key or keypad key under which the stored number has been programmed.

## PIN Codes

Your Administrator can assign you a PIN (Personal Identification Number) which locks your extension so that it can not be used to make external calls.

The PIN code also disables the SuperKey to prevent tampering with the feature programming on your extension.

When used at another extension, your PIN allows you to access features or make external calls which would not normally be available from this extension.

### Notes:

- You can still make internal calls and dial emergency numbers from a locked extension.

## PROGRAMMING

Program the **PIN CODE** key as described under *Programming a Personal Key*.

## OPERATION

*To lock your extension:*

1. Whilst your extension is idle, press the **PIN CODE** key or dial the Pin Code feature access code, **678**.
2. Dial your PIN code.  
*If you have a **PIN CODE** key programmed, it lights solid green indicating that the extension is locked.*
3. Replace your handset.

*To unlock your extension:*

1. Whilst your extension is idle, press the **PIN CODE** key or dial the Pin Code feature access code, **678**.
2. Dial your PIN code.  
*The **PIN CODE** key extinguishes, if programmed.*
3. Replace your handset.

*To make an external call from another user's locked extension:*

1. Whilst your extension is idle, press the **PIN CODE** key or dial the Pin Code feature access code, **678**.
2. Dial your PIN code.
3. Access a line and dial the required external number.
4. At the end of the call, replace your handset.  
*This extension remains unlocked for 60 seconds (default) allowing you to make further calls if required, after this time the extension returns to its locked state.*

## Priority Line Answer

With Priority Line Answer on, you can answer calls ringing at your extension (including calls to **LINE** keys) by lifting the handset or pressing the **Intercom** key or **Speaker** key. The feature is assigned on a line by line basis by the System Administrator and can include calls to Answer Next, Answer External Call, Extension Group and Line Group keys.

### PROGRAMMING

Priority Line Answer is programmed for you by your System Administrator.

### OPERATION

To answer on a line with Priority Line Answer:

- Lift the handset or press the **Intercom** key or **Speaker** key.  
*If you are not connected to the caller, the line does not have Priority Line Answer. Press the flashing key associated with the call to answer it.*

## Recall on Lines

Whilst in conversation with a called party at a remote site, you can make an enquiry call to another party on the remote site through the same line.

### PROGRAMMING

Program a **RECALL** key as described under *Programming a Personal Key*.

### OPERATION

Whilst in conversation with the first called party at the remote site:

1. Press the **RECALL** key to place the call on hold or press **Hold** followed by the Recall feature access code, **602**.
2. Dial the extension number of the second remote party.  
*You are already connected to the remote site and do not need to dial the line prefix.*
3. Speak to the second party.  
*Whilst in conversation with the second party and you wish to leave the two called parties in conversation, replace your handset.*
4. When the enquiry call is complete, press the **RECALL** key again.  
*You are re-connected to the first party.*

## Redial List

This feature allows you to save and prioritise up to ten externally-dialed numbers. You can define the position, in a stack of ten, which the last number you dialed should occupy.

Numbers can be stored:

- in an empty location;
- by overwriting previously occupied locations;
- at the top of the list -- if Position 1 is empty the process is complete. If there is an entry at Position 1, all the stored numbers move down the list until a blank space is reached or the store is full. If the store is full the last number in the list is discarded.

## PROGRAMMING

Program a **REDIAL PAD** key as described under *Programming a Personal Key*.

**Note:** You must have a pre-programmed **REDIAL PAD** key set up on your extension to use this feature.

## OPERATION

*To store the last externally-dialed number:*

1. Press the **REDIAL PAD** key.
2. Dial the digit corresponding with the position that you wish to store the number: number 1 is the first and 0 is the last. Using the \* key also places the number in the first position.  
*You hear dial tone when the number has been successfully stored.*

*To dial a number stored in the Redial List:*

1. Press **SuperKey**.  
*Scroll through the list of options until REDIAL LIST? is displayed.*
2. Press \*.  
*The first entry in the list is displayed.*
3. Press the  key repeatedly to scroll through the list until the required number is displayed.
4. Press # to dial the number.

## Re-establish

If a call you have transferred to another extension user is unanswered, the call returns to you to deal with. This feature allows you to re-attempt the transfer. When the returned call rings at your extension, the associated key flashes with orange with rapid cadence and a message similar to the following is displayed: EXTN xxxx REVERTED.

This feature should be read in conjunction with *Reverted Calls*.

### PROGRAMMING

**Note:** You must have a pre-programmed **RE-ESTABLISH** key set up on your extension to use this feature.

Program a **RE-ESTABLISH** key as described under *Programming a Personal Key*.

### OPERATION

*To re-establish a returned call without speaking to the caller:*

- Press the **RE-ESTABLISH** key.  
*The RE-ESTABLISH key lights solid orange.*

*To speak to the caller of the returned call and re-establish the call:*

1. Lift your handset.
2. Speak to the caller.  
*The RE-ESTABLISH key lights solid orange.*
3. Press the **RE-ESTABLISH** key.
4. Replace your handset.

## Reverted Calls

If a call you have transferred to another extension user is unanswered, the call returns to you to deal with. When the reverted call rings at your extension, the associated key flashes orange with rapid cadence and a message similar to the following is displayed: EXTN xxxx REVERTED.

### OPERATION

You can handle a reverted call in the following ways:

- Press the flashing key and speak to the caller.  
*Or*
- Answer the call as described above and then dial another extension number and transfer the caller to this extension.  
*Or*
- Attempt to re-establish the call as described under *Re-establish*.

## Ringback when Free

If you hear busy tone when you attempt to call an internal extension or access a line, you can reserve access to the extension or line as soon as it becomes available using this feature.

Your extension starts ringing when the called extension or line becomes available and automatically redials the other extension or accesses the line when you answer the ringback.

### Notes:

1. Ringbacks on lines only apply when the line is in use, and not when the called party is busy.
2. Your Administrator can set up the system so that a single-digit can be used instead of programming a **RING BACK** key. Contact your Administrator for a list of single-digit access codes.

## PROGRAMMING

Program the **RING BACK** key as described under *Programming a Personal Key*.

## OPERATION

*To place a ringback on a busy extension or line:*

- Whilst listening to busy tone, press the **RING BACK** key or dial the single-digit access code, 5 (system default).  
*If programmed, your **RING BACK** key lights solid orange, and dial tone is returned to indicate successful activation.*

*When the target extension or line becomes available:*

1. Your extension rings and your **RING BACK** key, if programmed, and **Intercom** flash. A message similar to the following is displayed: EXT xxxx RINGBACK.
2. Lift your handset to take the call or press the flashing key.  
*If you had placed the ringback on an extension you hear ringing tone, if placed on a line you hear dial tone.*  
*If programmed, your **RING BACK** key extinguishes indicating that the call can be handled in the normal way.*

**Note:** If you do not respond to the ringback within 30 seconds or you obtain access to the required extension or line before the ringback matures, your request is cancelled.

*To cancel a ringback:*

- Whilst your extension is idle, press the **RING BACK** key or dial the single-digit access code, 5.



## Ringer On/Off

All incoming external calls that arrive at your extension under programmed personal keys ring to indicate the arrival of the call. This feature allows you to turn off your extension's Ringer. All external calls that arrive at your extension, under a programmed personal key, will be indicated by the key flashing. The keys affected by this feature are:

- **LINE** key;
- **LINE GROUP** key
- **CALLS FOR** key;
- **ANSWER EXTERNAL** key
- **ANSWER NEXT CALL** key.

### PROGRAMMING

Program the **RINGER ON/OFF** key as described under *Programming a Personal Key*.

### OPERATION

**Note:** You must have a pre-programmed **RINGER ON/OFF** key set up on your extension to use this feature.

*To turn the Ringer off:*

- Press the **RINGER ON/OFF** key.  
The **RINGER ON/OFF** key lights solid orange and **RINGER OFF** is displayed indicating that your extension does not ring when an external call arrives.  
Repeatedly pressing the **RINGER ON/OFF** key toggles between switching your extension's Ringer on and off.

## Selective Ringer

All incoming external calls that arrive at your extension under programmed personal keys ring to indicate the arrival of the call. This feature allows you to select which keys, programmed for incoming external calls, do not ring at your extension. When this feature is active, external calls incoming on the selected keys, do not ring, however the relevant line key flashes and your LCD indicates the incoming call.

### PROGRAMMING

Program the **SELECTIVE RINGER** key as described under *Programming a Personal Key*.

### OPERATION

**Note:** You must have a pre-programmed **SELECTIVE RINGER** key set up on your extension to use this feature.

*To disable your extension's Ringer for selected incoming external calls:*

1. Press the **SELECTIVE RINGER** key.  
*The **SELECTIVE RINGER** key flashes indicating that you must press a **LINE** or **LINE GROUP** key.*
2. Press the **LINE** or **LINE GROUP** key(s) that you wish to silence.  
*The selected **LINE** or **LINE GROUP** keys light solid orange, indicating selection, and extinguish after a few seconds.*
3. Press the **SELECTIVE RINGER** key again, or replace your handset.  
*The **SELECTIVE RINGER** key lights solid orange indicating that the feature is active.*

**Note:** If you press the **SELECTIVE RINGER** key or replace your handset before the pre-defined time expires, you cancel the activation request.

*To resume normal operation:*

- Press the **SELECTIVE RINGER** key.  
*The key extinguishes; the feature is turned off.*

## Split Divert

This feature allows you divert your internal and external calls to different destinations. You also have the option to divert one type of call (e.g., internal calls) but not the other. The target destination can be another extension or extension group. To divert all your calls to an external number, use External Divert. This feature can be set up using the SuperKey or feature access codes and does not have to be programmed to a personal key. Refer to the *Operation* section for **SuperKey** and feature access codes set-up instructions.

### Notes:

1. Up to two types of diversions (All or No Answer/Busy) can be on at the same time, one for internal calls and one for external calls.
2. Divert All, External Divert and Follow Me apply to both internal and external calls. Activating either of them will deactivate any other diversion currently on.

### PROGRAMMING

1. Press **SuperKey**.
2. Press # repeatedly until PERSONAL KEYS? is displayed.
3. Press \* to select this option.
4. Press the key to be programmed. If a feature is already stored under the selected key, the existing feature is displayed with the option to change or clear the key.
5. Press \* to change the feature stored under the selected key.
6. Press # repeatedly until CALL DIVERT is displayed.
7. Press \* to select this option.
8. Press #.
9. Do one of the following:
  - a. To program Divert All, press \* for internal calls or # for external calls.
  - b. To program Divert on No Answer or Busy, press # repeatedly until the required prompt displays, and then press \*.  
*At this point, you can choose to program the key with or without a destination extension or extension group.*
10. Either, enter an extension number or extension group number, and then \* to save it.
11. Alternatively, press \* to divert to an unspecified extension or # to divert to an unspecified extension group. You must then specify an extension or extension group after you press the programmed key to activate the diversion.
12. Press **SuperKey** to complete the programming.

### OPERATION

**Note:** If you activate a diversion using **SuperKey**, and a diversion is already active via a programmed **DIVERT** key, the current diversion is overridden, and vice versa.

## Diverting your calls using SuperKey

To divert all your calls to another extension or extension group using SuperKey:

1. Press **SuperKey**.
2. At the CALL DIVERT? prompt, press \*.
3. At the ALWAYS? prompt, press \* for Divert All or # for Divert on No Answer or Busy.
4. At the ALWAYS ALL prompt, press #.
5. Do one of the following:
  - a. To program Divert All, press \* for internal calls or # for external calls.
  - b. To program Divert on No Answer or Busy, press # repeatedly until the required prompt displays, and then press \*.  
*At this point, you can choose to program the key with or without a destination extension or extension group.*
6. Either, enter an extension number or extension group number, and then \* to save it.
7. Alternatively, press \* to divert to an unspecified extension or # to divert to an unspecified extension group. You must then specify an extension or extension group after you press the programmed key to activate the diversion.
8. Press **SuperKey** to complete the programming.

## Diverting your calls using a programmed key

To divert all your calls using a key programmed with a destination number:

- Press the SPLIT DIVERT key.  
*The key lights solid red. When you lift your handset, you hear interrupted dial tone indicating that you are diverting your calls.*

## Diverting your calls using a programmed key

To divert all your calls using a key programmed with a target number:

- Press the SPLIT DIVERT key.  
*The key lights solid red. When you lift your handset, you hear interrupted dial tone indicating that you are diverting your calls.*

To divert all your all calls to another extension or extension group using a key which does not have an extension or extension group programmed:

1. Press the **SPLIT DIVERT** key.
2. Dial an extension or extension group number, or press a **DSS/BLF** or **EXTENSION GROUP** key.  
*The **SPLIT DIVERT** key lights solid red. When you lift your handset, you hear interrupted dial tone indicating that you are diverting your calls.*

## Diverting your calls using the feature access code

To divert your calls using access codes:

1. Dial the one of the following codes:
  - **621** - to divert internal calls always to an extension
  - **622** - to divert internal calls on no answer or busy to an extension
  - **629** - to divert internal calls always to an extension group
  - **627** - to divert internal calls on no answer or busy to an extension group
  - **631** - to divert external calls always to an extension
  - **638** - to divert external calls always to an extension group
  - **632** - to divert external calls on no answer or busy to an extension
  - **639** - to divert external calls on no answer or busy to an extension group
2. Dial an extension number, or press a **DSS/BLF** key. When you lift your handset, you hear interrupted dial tone indicating that you are diverting your calls.

## Cancelling

To cancel a diversion using SuperKey:

1. Press **SuperKey**.  
*CALL DIVERT? is displayed.*
2. Press \* to select the feature.
3. Press \* to cancel Divert All or # to cancel Divert on No Answer or Busy.
4. Press \*.
5. Press #.
6. Press \* to cancel diversion of internal calls or # to to cancel diversion of external calls.
7. Press \*.  
*Divert is active if the destination number is displayed with a \* prefix.*
8. Press \* to change the diversion.
9. Press # to turn off the diversion.  
*The asterisk is removed.*
10. Press **SuperKey**.

To cancel a diversion using a programmed key or access code:

1. Press the active **SPLIT DIVERT** key or dial **612** to cancel internal call diversion or **630** to cancel external call diversion.  
*If you have a **SPLIT DIVERT** key, the key extinguishes.*

## System Hold

This type of hold allows you to place internal or external calls on System Hold by pressing the programmed **DSS/BLF** or **LINE** key. You can also place external calls on System Hold using the Call Park feature (refer to *Call Park* for more information). Other extension users can retrieve the call in the following ways:

1. dialling the Call Park Pick-up feature access code if placed on hold using Call Park (refer to *Call Park Pick-up* for more information);
2. pressing the **LINE** key for the held party;
3. pressing the **DSS/BLF** key of the holding party.

## OPERATION

Refer to *Call Park* for information on placing calls on hold using the Call Park feature.

To place a call on System Hold:

- Whilst in conversation with an established call, press the associated **DSS/BLF** or **LINE** key.  
*The call is placed on hold. The associated **DSS/BLF** or **LINE** key, flashes red with held cadence and you hear dial tone.*

To retrieve a held call:

- Whilst your extension is idle, press the associated **DSS/BLF** or **LINE** key.  
*You are re-connected to the held party.*

To toggle between the current call and a call on hold:

- After placing a call on hold as described above, and in conversation with another party, press the associated **DSS/BLF** or **LINE** key, if available, or press **Intercom**.  
*The current call is placed on hold and you are re-connected to the held party.*

## System Speed Call Numbers

Mitel Networks 3100 ICP provides a speed-dialling memory which can contain up to 1000 external numbers, each of which can have a maximum of twenty digits. An Administrator stores each number against a four-digit System Speed Call number and you can dial the stored numbers either by dialling the System Speed Call number or by storing the number under a personal key and pressing the key. System Speed Call numbers can only be set up and changed by an Administrator.

**Note:** Contact your Administrator for a list of System Speed Call numbers.

### PROGRAMMING

1. Press **SuperKey**.  
*Scroll through the list of options until PERSONAL KEYS? is displayed.*
2. Press \* to select this option.
3. Press the personal key under which the System Speed Call number is to be stored.  
*If a feature or number is already stored under the selected key, the existing feature or number is displayed with the option to change or erase.*
4. Press \* to change the feature stored under the selected key.
5. Press # repeatedly to scroll down the list until SPEED CALL is displayed.
6. Press \* to select this option.
7. Dial the four-digit System Speed Call number that you wish to store.  
*At any time during the dialling sequence you can press the \* to erase previously inserted digits.*
8. Press # to save.
9. Press **SuperKey**.
10. Write the System Speed Call number on the key label.

### OPERATION

*To dial an external call using a System Speed Call number:*

- Dial the required System Speed Call number.

*To dial a System Speed Call number held under a personal key:*

- Press the required System Speed Call key.

## Three-Party Conference

This feature enables you to set up a conference call between three parties. The conference can consist of:

- three extension users;
- two extension users and an external caller;
- one extension user and two external callers.

**Note:** Contact your Administrator to check that your extension is set up to hold a conference call with two external parties.

### OPERATION

*To set up a three-party conference call:*

1. Establish a connection with an extension user or external call.
2. Press **Trans/Conf** and establish a connection with a third party.
3. Press **Trans/Conf**.

*All three parties are connected.*

*All extension users involved in the conference have THREE PARTY displayed on their LCDs.*

*To clear down from a three-party conference call:*

- Replace your handset.  
*The other parties in the conference remain connected.*

*To hold a private conversation with one party during in a three-party conference:*

**Note:** This is only available to the originator of the conference call.

- Press **Trans/Conf** or press the associated **DSS/BLF** key, if programmed.  
*You are connected to the chosen party and the other party hears silence, music on hold or tone.*

## Withhold Identity

For each external call, you can control whether or not your phone number displays on the called party's phone.

### PROGRAMMING

Program the **WITHHOLD IDENTITY** key as described under *Programming a Personal Key*.

### OPERATION

*To withhold your identity from the called party:*

- Press the **WITHHOLD IDENTITY** key or dial **676**.  
*The WITHHOLD IDENTITY key toggles call blocking on and off; whereas, the access code only activates it, meaning the code must be dialled each time the feature is used.*
- Press a line key or dial the out access code.
- Dial the external number.

## Who Am I?

This feature displays the number of your extension on your LCD.

### OPERATION

*To discover your current extension's number:*

- Dial the Who Am I? feature access code, **675**.  
*The following message is displayed: THIS IS EXT xxxx*  
*After five seconds the extension number is removed from the display, and dial tone is returned.*



# TIPS FOR YOUR COMFORT AND SAFETY

## Don't cradle your handset!

Prolonged use of the handset, if you cradle the handset between your ear and shoulder, can lead to neck, shoulder or back discomfort. If you use your phone for long periods, you may find it more comfortable to use a headset.

## Protect your Hearing

Your phone has a control for adjusting the volume of the handset receiver or headset. Because continuous exposure to loud sounds can contribute to hearing loss, keep the volume at a moderate level.

## Angle the phone for easier viewing

The stand built into your phone tilts to give you a better view of the keys and display.

### *To tilt your telephone:*

1. Press the release tabs on these sides of the stand.
2. Snap the four hooks on the back of the stand into either the upper or lower notches on the back of the phone.

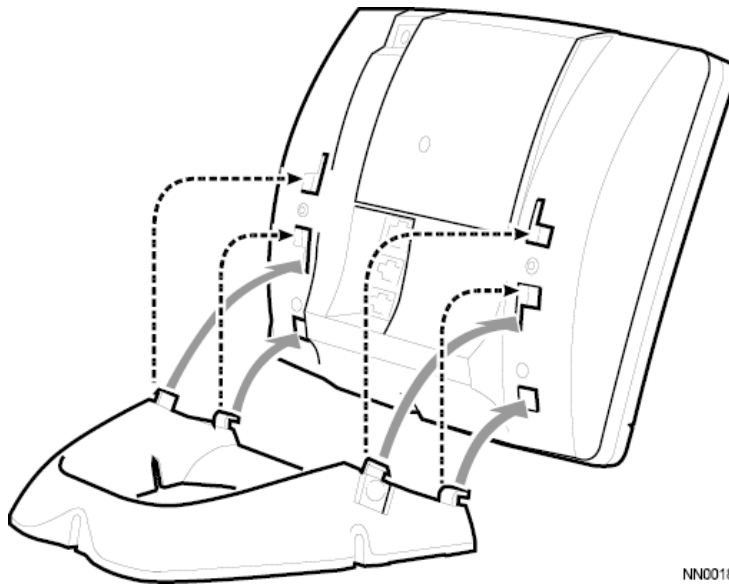

NN0018

# GLOSSARY

## A

Absent/Present	Works in conjunction with the Calls For feature allowing you to send all your calls to another extension by pressing the pre-programmed ABSENT/PRESENT key.
account code	A three-digit access code which is used for tracking or allocation purposes. Account codes are often used by companies that need to bill clients for telephone expenses, for example, accountants and lawyers.
Administrator	The person responsible for the day-to-day running of the system; an Administrator configures and maintains the system.
auto answer	Automatically answers an incoming internal call. Your extension does not ring to indicate the incoming call and you do not need to lift the handset to answer the call. This feature is only available from a Mitel Networks 5215 IP Phone.

## B

BLF	Busy Lamp Field. A personal key which is programmed with an extension user's number; the key's light gives the status of the extension.
Broker's Call	Allows you to alternate between two calls; neither person can overhear your conversation with the other.
browser	A GUI-based application which allows you to access documents on the Internet.
busy	Your extension is assumed to be busy when you lift the handset or press Intercom.

## C

cadence	Used on the system for the key lights and ringing to differentiate between calls and the status of calls at your extension.
Call Park	Places an external call on hold which can be picked up by any extension user on the system.
Call Park Pick-up	Allows you to pick up call that was parked using the Call Park feature.
callers	Internal and external people who make calls to extensions.
Calls For	Allows you to answer calls that another extension user has diverted to you using the Absent/Present feature.
clear	Removes or cancels a feature programmed on a personal key.
CLI	Calling Line Identity. A CLI is a number that is sent by the network to identify an incoming call.
CLIP	Calling Line Identity Presentation. Displays the number of an incoming external caller. If the external number is included in the System or Personal Directory, the number is replaced by the associated name in the directory.
conference call	A connection between three parties simultaneously.

## D

Divert All	Diverts all your calls to another extension or extension group.
Divert on No Answer or Busy	Diverts your calls to another extension or extension group when you are unable to take the call or busy on another call.
Doorphone	An extension which is connected to the door interface; this extension rings when someone requires entry. When answered the extension user is connected to the Door Intercom.
DSS	Direct Station Selection. A personal key which is programmed with an extension user's number; pressing this key enables you to directly dial, transfer a call to or pickup a call ringing at the extension.
DSS/BLF key	Direct Station Selection/Busy Lamp Field key. Personal key assigned with the number of another extension.

## E

exclusive hold	Call placed on hold which can only be picked up by the extension user who placed the call on hold.
extension	The physical Mitel Networks 5215 IP Phone sitting on your desk.
extension group	A group of extensions, which is set up by an Administrator, to which calls are directed using a single number. For example, an extension group could contain all extensions in a Sales Department. An extension group can be: 1) standard (all idle extensions ring simultaneously); 2) fixed (all idle extensions in the group ring sequentially, starting with the first extension, until the call is answered); 3) moving (all idle extensions in the group ring sequentially, starting with the extension following the extension that answered the previous call, until the call is answered)
extension paging	Makes an announcement through an extension's speaker. An extension user can page a single extension user, an extension group or all extensions on the system.
External Divert	Sends your incoming calls to an external destination -- for example, a mobile phone or your home number.
external listen	Monitors a call between two external parties.

## F

feature access code	Gives you access to certain system features.
fixed-function keys	Keys on the Mitel Networks 5215 IP Phone which have specific functions; these functions cannot be deleted or modified.
follow me	Temporarily diverts your calls to another extension before you leave your desk to work at another desk.

## G

group call pick-up	Allows you to answer a call that is ringing at another extension in your pick-up group.
group listen	Turns on your extension's speaker so that others nearby can listen to the call.

## H

Hold	Allows you to place another party on system hold.
------	---

## I

Intercom	Key used to indicate incoming calls at your extension and also allows you to retrieve calls placed on hold.
----------	---

## K

keypad The buttons on your Mitel Networks 5215 IP Phone, numbered 1 to 0, plus \* and #, which allow you to dial a telephone number or dial a feature access code.

## L

LCD Liquid Crystal Display. Two-line, 20 character, alpha-numeric display which gives a visual indication of the current status of your extension.

## N

Night Service Pick-up group Allows you to answer a call that is ringing at another extension in your Night Service pick-up group.

## O

out access digit You must key in the out access digit before you dial an external number, the digit used is usually 9.

## P

personal speed call key Allows you to dial a number using a single or two key presses (this is dependent on which key the number is programmed under).

Phonebook Allows you to search for and access numbers stored in your Personal Directory and the System Directory. If you receive an incoming call from a person who you have an entry for in your Personal Directory or in the System Directory, the name attached to the incoming call is displayed on the LCD instead of the telephone number.

pick-up Allows you to answer a call that is ringing at another extension.

PIN code Personal Identification Number.

Programmable Key Module The 5448 PKM provides 48 additional personal keys. The 5448 PKM can be attached to 5215 IP Phones.

## R

re-establish Allows you to retry a transfer to an extension that went unanswered using a single key press.

ringback Allows you to reserve access to an extension or line when you receive busy tone; when the extension or line becomes available you are automatically called back.

## S

scroll	Moves through a window or the choices in a list to view a part of the window or list that is not currently visible.
Shift	This key is used to program and access Personal Speed Call numbers saved as secondary features under personal keys and keypad keys. Pressing Shift twice redials the last externally-dialled number.
Shuttle	<i>See Broker's Call.</i>
softkey	The softkeys used in conjunction with SuperKey to set up features under personal keys, set-up call diverting and navigate through the Phonebook. Softkeys are only available on 5215 IP Phones.
SuperKey	This key is used for storing features under personal keys and setting up call diversions. When using a Mitel Networks 5215 IP Phone gives you access to the Phonebook allowing you to make calls from the System Directory and your Personal Directory.
System Backstop	The System Backstop is the last extension or extension group to be presented with a call which has been unanswered. Calls can be diverted to the System Backstop for a number of reasons, for example, a reverted call goes unanswered or both the Manager and Secretary press their ABSENT/PRESENT keys when working in a one-to-one situation.
system hold	Call placed on hold which can be picked up any extension user on the system.
system speed call	Allows you to dial an external number using a four-digit number which is set up the Administrator instead of dialling the full number.
system speed call key	Allows you to dial a System Speed Call number using a single key press.

# ACCESSING FEATURES

All the features shown in the following can be assigned to a personal key and are programmed via **SuperKey**. The *Additional Information Required* column indicates whether optional or mandatory information is required when setting up the personal key, for example, the inclusion of an extension number. Some of the features listed in this table can also be activated by dialling a feature access code; these features are listed on the next page.

<b>Feature Name</b>	<b>Additional Information Required</b>
Account Codes	Optional
Broker's Call (Shuttle)	n/a
Cancel Message Waiting	Optional
Divert All to an Extension*	Optional
Divert All to an Extension Group*	Optional
Divert No Answer/Busy to an Extension*	Optional
Divert No Answer/Busy to an Extension Group*	Optional
Divert No Answer/Busy to an Extension or Extension Group**	Optional
Divert No Answer/Busy to an Extension or Extension Group**	Optional
Do Not Disturb (DND)	n/a
Extension Paging	Optional
External Divert	n/a
Follow Me	Optional
Group Call Pick-up	n/a
Last Call Duration Display	n/a
Message Waiting	n/a
Night Service Pick-up	n/a
PIN (Personal Identification Number) Codes	n/a
Recall on Lines	n/a
Split Divert Cancel - Internal Calls	n/a
Split Divert Always - Internal Calls	Optional
Split Divert No Answer/Busy - Internal Calls	Optional
Split Divert Cancel - External Calls	n/a
Split Divert Always - External Calls	Optional
Split Divert No Answer/Busy - External Calls	Optional

\* Applies to systems with Release 3.3 and earlier software.

\*\* Applies to systems with Release 4.0 and later software.

# FEATURE ACCESS CODES

Ringer Pitch (1 to 8)	651
Account Codes	665
Alarm Calls	668
Alarm Call Cancel	669
Call Park Pick-up	660
Directed Call Pick-up	677
Divert All to an Extension or Extension Group	611
Divert Always to an Extension Group	618
Divert No Answer/Busy to an Extension or Extension Group	620
Divert No Answer/Busy to an Extension Group	619
Cancel Divert	617
Do Not Disturb (DND)	607
Extension Paging	644
External Call Waiting	687
Remote Call Forward	688
Follow Me	641
Cancel Follow Me	640
Follow Me (I'm Here)	642
Group Call Pick-Up	666
Last Call Duration Display	663
Last Call Cost Display	664
Last Number Redial	600
Cancel Message Waiting	628
Directed Message Waiting	673
Message Waiting	643
Night Service Pick-Up	696
PIN Codes	678
Recall on Lines	602
Split Divert Always to an Extension - Internal Calls	621
Split Divert No Answer/Busy - Internal Calls	622
Split Divert Always to an Extension Group - Internal Calls	629
Split Divert No Answer/Busy to an Extension Group - Internal Calls	627
Split Divert Always to an Extension - External Calls	631
Split Divert Always to an Extension Group - External Calls	638
Split Divert No Answer/Busy - External Calls	632
Split Divert No Answer/Busy to an Extension Group - External	639



## **FEATURE ACCESS CODES ( continued )**

Cancel Split Divert - Internal Calls	612
Cancel Split Divert - External Calls	630
Withhold Identity (UK)	676
Who Am I? Indication	675



™, © Trademark of Mitel Networks Corporation.  
© Copyright 2003, Mitel Networks Corporation.  
All rights reserved.