

MITEL NETWORKS

5005 | IP Phone

USER GUIDE

 **MITEL** | it's about **YOU**

Table of Contents

5005 IP PHONE	1
Mitel Networks™ 5005 IP User Guide	1
Notice	1
Disclaimer	1
About The 5005 IP Phone	2
About Your Set	2
Related Topics	2
Important Safety Instructions And Precautions	3
Supplying Power To The Phone	3
Notices	3
Symbols	3
Initializing And Registering The Phone	4
Using The 5005 IP Phone	4
About Using The 5005 IP Phone	4
Telephone Status Indicators	4
Adjusting Volume Levels	5
Adjusting Display Contrast	5
Programming The Function Keys	6
Desktop Stand	7
Mounting The Phone On The Wall	8
Mounting On The Wall Using A Bracket (North America)	8
Mounting On The Wall Using The Desktop Stand	9
Call Handling	9
About Call Handling	9
Making And Answering Calls	11
Program	11
Hold	13
Call Forward Variations	13
Call Me Back	16
Camp-On	16
Cancel	16
Line Keys	16
Message	17
Redial	17
Transferring And Conferencing	18
Account Code	18
Advisory Messages	19
Answer Variations	19

Table of Contents

Calls For	20
Call Park.....	20
Call Pickup	20
Cancel Message Waiting	21
Do Not Disturb.....	21
Direct Station Selection/Busy Lamp Field (DSS/BLF)	21
Extension Group.....	22
Extension Paging	22
Group Listen.....	22
Hold Variations	23
Exclusive Hold.....	23
Last Call Duration Display.....	24
Line Group.....	24
Locking/Unlocking The Phone	24
Night Service	25
Re-establish	26
Ringer On/Off	26
Speed Call.....	26
Swap	27
Index.....	28

5005 IP Phone

Mitel Networks™ 5005 IP User Guide

Notice

The information contained in this document is believed to be accurate in all respects but is not warranted by Mitel Networks Corporation (Mitel). The information is subject to change without notice and should not be construed in any way as a commitment by Mitel or any of its affiliates or subsidiaries. Mitel and its affiliates and subsidiaries assume no responsibility for any errors or omissions in this document. Revisions of this document or new editions of it may be issued to incorporate any such changes.

Nothing in this document may be reproduced in any manner, either wholly or in part for any use whatsoever, without written permission from Mitel Networks Corporation.

Disclaimer



DUE TO THE DYNAMIC NATURE OF THE PRODUCT DESIGN, THE INFORMATION CONTAINED IN THIS DOCUMENT IS SUBJECT TO CHANGE WITHOUT NOTICE. MITEL NETWORKS CORPORATION, ITS AFFILIATES, AND/ OR ITS SUBSIDIARIES ASSUME NO RESPONSIBILITY FOR ERRORS AND/OR OMISSIONS CONTAINED IN THIS INFORMATION.

®, ™ Trademark of Mitel Networks Corporation
© Copyright 2002, Mitel Networks Corporation
All rights reserved.

About The 5005 IP Phone

About Your Set

The Mitel Networks 5005 IP Phone is a fully-featured, digital telephone that connects directly to a 10/100BaseT Ethernet network.

The Mitel Networks 5005 IP phone is supported by the Mitel Networks 3100 Integrated Communications Platform (ICP) Release 3.0 and later software.

 **Note:** The 5005 IP phone is not suitable for direct connection to ANY public telephone network. Connect the phone to a LAN that is attached to a Mitel-manufactured ICP system only.

The Mitel Networks 5005 IP phone has two fixed-function keys (HOLD and CANCEL) and twenty programmable keys with built-in status indicators along with a Volume Up/Down key and a standard numeric keypad.

 **Note:** The three bottom-most programmable function keys will automatically be assigned the REDIAL, MESSAGE and TRANS/CONF features automatically and the top-left programmable key will automatically be assigned as the primary LINE key. See About Call Handling for more details.



Related Topics

[Important Safety Instructions And Precautions](#)

[Supplying Power To The Phone](#)

[Notices](#)

[Initializing And Registering The Phone](#)

Important Safety Instructions And Precautions

When using your telephone equipment, basic safety precautions should always be followed to reduce the risk of fire, electric shock and injury to persons, including the following:

- Do not use this product near water, for example, near a bathtub, wash bowl, kitchen sink or laundry tub, in a wet basement or near a swimming pool.
- Avoid using a telephone (other than a cordless type) during an electrical storm. There may be a remote risk of electric shock from lightning.
- Do not use the telephone to report a gas leak in the vicinity of a leak.

Tips for Your Comfort and Safety

Don't cradle the handset!

Prolonged use of the handset can lead to neck, shoulder, or back discomfort, especially if you cradle the handset between your ear and shoulder. If you use your phone a lot, you may find it more comfortable to use a headset. See the section on headset usage elsewhere in this guide for more information.

Protect your hearing

Your phone has a control for adjusting the volume of the handset receiver. Because continuous exposure to loud sounds can contribute to hearing loss, keep the volume at a moderate level.

Supplying Power To The Phone

The phone may be powered from any of the following sources:

- A Mitel Networks 3100 Integrated Communications Platform (ICP).
- A Mitel-supplied DC power adapter (part numbers 50002070 [North America], 50002080 [UK], and 50002090 [Europe]).
- A power source meeting the requirements of IEEE 802.3af for Power Over LAN, as well as CAN/CSA C22.2 No. 60950-2000 3rd. Ed., UL 60950 3rd. Ed., and/or EN60950:2000 3rd. Ed. for Safety.
- Any other Mitel-recommended power source.

Notices

These notices may appear on the product and in the technical documentation.

DANGER	Danger indicates an imminently hazardous situation which, if not avoided, will result in death or serious injury.
WARNING	Warning indicates a potentially hazardous situation which, if not avoided, could result in death or serious injury.
CAUTION	Caution indicates a potentially hazardous situation which, if not avoided, may result in minor or moderate injury and/or damage to the equipment or property.

Symbols

This symbol may appear on the product.



The exclamation point within an equilateral triangle indicates that important operating and maintenance (servicing) instructions are included in the literature accompanying the product.

Initializing And Registering The Phone

IP phone initialization occurs automatically when the set is connected to the network.

CAUTION: During the initialization process, the phone may download crucial "boot" data from the TFTP server on the network. This will be indicated by the display screen showing DO NOT POWER DOWN and the light indicator (LED) flashing. DO NOT POWER DOWN OR TURN OFF THE PHONE DURING THIS PROCESS! If the phone is powered down at this point, "boot" data is likely to be corrupted and the phone will not boot up properly when powered on.

All IP sets are required to complete PIN registration. This registration results in a MAC address being assigned in the MAC Address Assignment form. The 5005 IP phone will register with the 3100 ICP automatically.

Once the phone is registered, it can be moved to any switched 10/100baseT port that is reachable by the 3100 ICP, DHCP and TFTP servers servicing the IP phones so long as the phone is locally powered. The phone will automatically boot and re-register with the 3100 ICP system whenever it is moved.

 **Note:** Initializing and registering the 5005 IP phone is a procedure that should only be carried out either by a trained technician or your System Administrator. Please consult with your System Administrator before performing any procedures that may have an adverse effect on the performance of the phone.

Using The 5005 IP Phone

About Using The 5005 IP Phone

The 5005 IP Phone is a single-port telephone designed for use with a Mitel Networks 3100 Integrated Communications Platform (ICP) integrated with your organization's network.

Related Topics

Adjusting Volume Levels

Telephone Status Indicators

Adjusting Display Contrast

Programming The Function Keys

Desktop Stand

Mounting The Phone On The Wall

About Call Handling



Telephone Status Indicators

Situation:	The message waiting indicator is:
Line is idle	Off
Line is ringing	Flashing rapidly
Message waiting/Voicemail	Flashing slowly

Adjusting Volume Levels



Ringer Control

To adjust the Ringer Volume while the set is ringing:

- Press  to increase the volume.
- Press  to decrease the volume.



Handset Receiver Volume Control

To adjust the Handset Receiver Volume when you are using the handset:

- Press  to increase the volume.
- Press  to decrease the volume.

Adjusting Display Contrast

To adjust the contrast level of the display screen while the phone is not in use:

- Press  to brighten the contrast.
- Press  to dim the contrast.

Programming The Function Keys

Programming the function keys on your 5005 IP phone is done either directly on your phone using the PROGRAM key or using the Desktop Tool to access the 3100 ICP on your network with your computer. Features such as speed dial keys, programming key definitions and Call Forwarding can all be programmed using either the PROGRAM key or the Desktop Tool.

The Desktop Tool, as seen below, is accessed through a web browser.

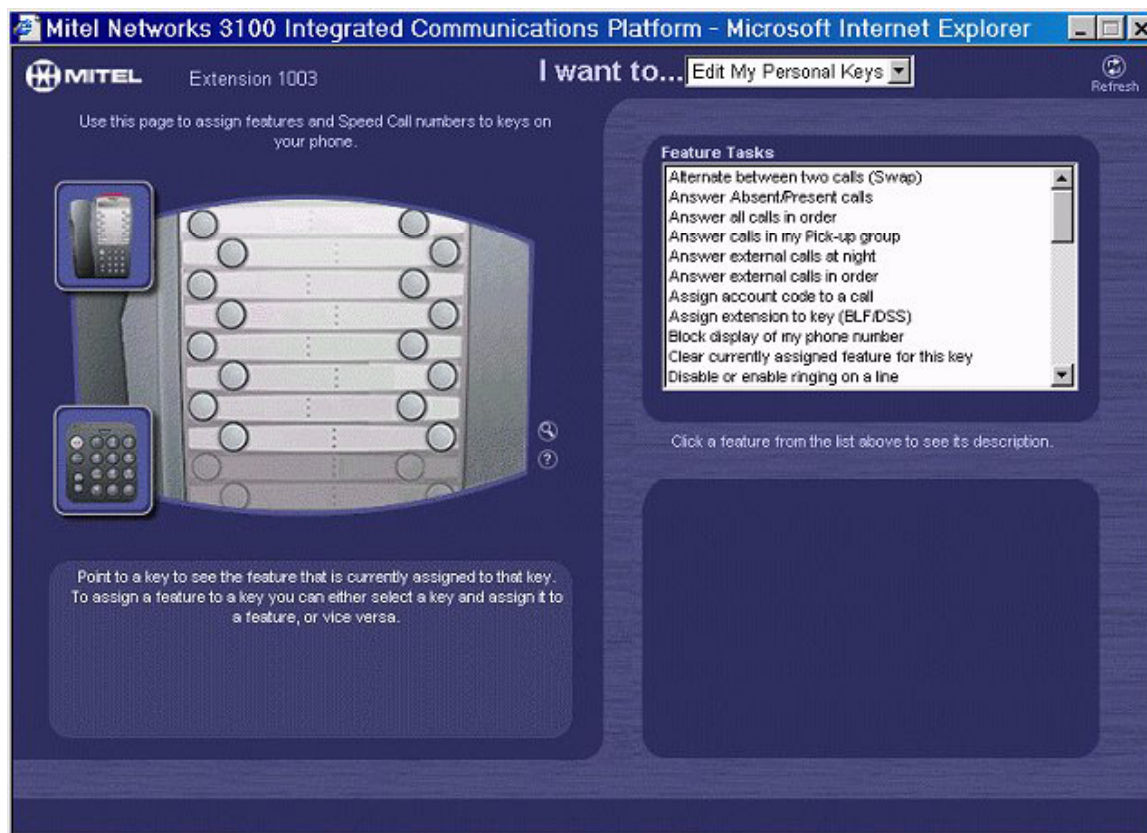

Desktop Tool Screen

For more information on using the Desktop Tool, please contact your System Administrator.

Desktop Stand

To tilt the 5005 IP phone towards you, it can be mounted on a stand as illustrated below.

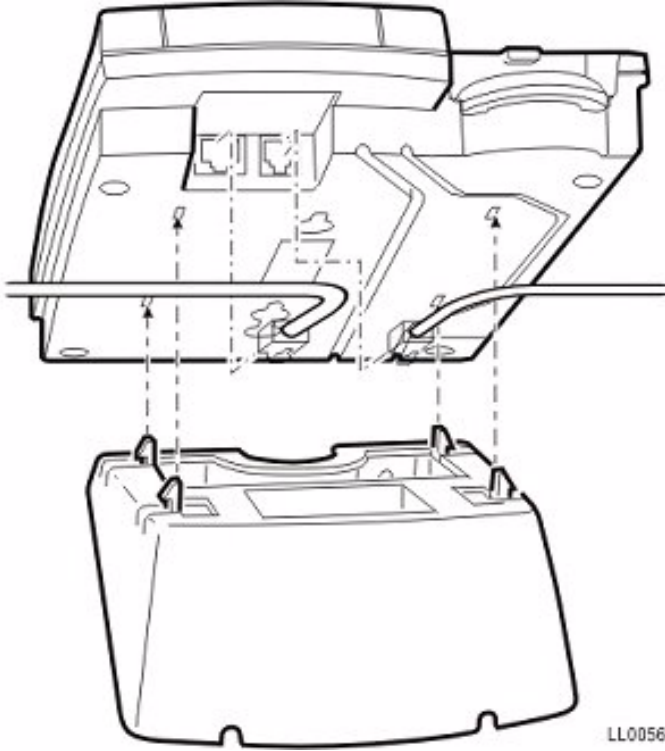



LL0056

Mounting The Phone On The Wall

Mounting On The Wall Using Screws (UK/Europe)

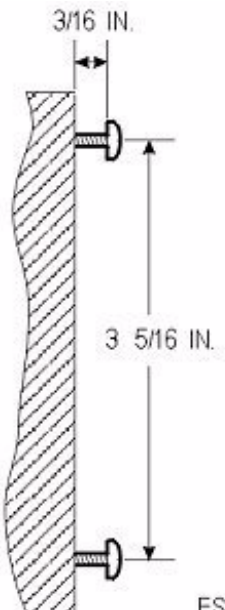
The 5005 IP phone can be mounted directly on a wall using mounting screws:

<ol style="list-style-type: none"> 1. Select a location away from electrical cables, pipes or other items behind the mounting location that could cause a hazard when inserting screws in the wall. 	
<div style="display: flex; align-items: center;">  <div style="border: 1px solid red; padding: 5px;"> <p>CAUTION: Make sure the wall material is capable of supporting the weight of the unit. For additional security, it is recommended that you mount the phone on a plywood backboard. Mitel Networks is not responsible for units damaged as a result of improper wall mounting.</p> </div> </div>	
<ol style="list-style-type: none"> 2. Insert two mounting screws 3 5/16 inches (8.4 cm) apart as illustrated to the right. Allow about 3/16 of an inch (0.5 cm) between the wall and screw heads for mounting the phone. 	
<ol style="list-style-type: none"> 3. Use #10 screws 1 to 1.5 inches (2.5 to 4 cm) in length for mounting screws and anchoring devices suitable for the wall material on which the unit will be mounted. 	
<ol style="list-style-type: none"> 4. Align the mounting slots on the back of the phone with the heads of the screws and push until the unit is firmly seated 	

Mounting On The Wall Using A Bracket (North America)

The 5005 IP phone can be mounted directly on a wall using a standard telephone wall mount bracket available from your telephone equipment dealer.

Simply align the mounting slots on the back of the phone with the posts on the bracket and push until the unit is firmly seated.

Mounting On The Wall Using The Desktop Stand

The 5005 IP phone can also be mounted on a wall using the desktop stand. To mount the phone in this fashion, attach the stand to the base of the phone in an inverted position and then place the stand on the wall mounting bracket as illustrated.

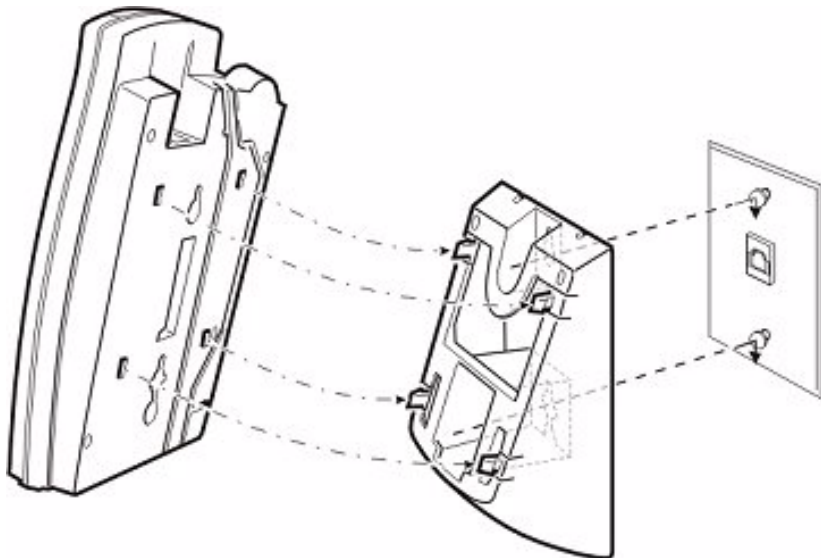

LL0057

 **Note:** While mounting screws or a standard wall mount bracket may be used to mount the phone on the wall, standard telephone jacks are not used as the phone is connected directly to the LAN.

Call Handling

About Call Handling

Please ensure that the designation card on the 5005 IP Phone, sitting on your desk, has the same annotations as shown below. If not, please contact your System Administrator.



 **Note:** The three bottom-most programmable function keys should be labelled REDIAL, MESSAGE and TRANS/CONF. The top-left programmable function key will automatically be assigned as the primary LINE key.

Related Topics

Standard Usage

- Making & Answering Calls
- Program (& Advisory Messages)
- Hold
- Cancel
- Redial
- Message
- Transfer/Conference

Keys Programmed By User

- Account Code
- Answer External Call
- Answer Next Call
- Call Forward
- Call Me Back
- Call Park
- Call Pickup
- Calls For
- Cancel Message Waiting
- Do Not Disturb
- DSS/BLF
- Extension Group
- Extension Paging
- Group Listen
- Hold - Call Store
- Hold - Exclusive Hold
- Last Call Duration Display
- Line Group
- Line Keys
- Locking/Unlocking
- Night Service Monitoring
- Night Service Pick-up
- Re-establish
- Ringer On/Off
- Speed Call
- Swap

Making And Answering Calls

To make a call using the handset:

- Lift the handset.
- Dial the number.

 **Note:** To use a line other than the primary one assigned to the set, press one of the Line keys before you dial the number.

To make a call using a Speed Call key:

- Lift the handset.
- Press the Speed Call key to dial a pre-programmed number.

 **Note:** Speed Call keys must be programmed using the Desktop Tool as described in Programming The Function Keys. Speed Call keys may be used either for telephone numbers or to send a multi-digit password during a call.

To answer a call:

- Lift the handset.

Program

The **PROGRAM** key is automatically programmed by the 3100 ICP to allow you to assign features to programmable keys. It is the programmable function key located second from the bottom on the right (above the TRANS/CONF key).

It will not be possible to program a feature or short code on this key.

To program a feature under a programmable key:	Feature Name	Code
1. Press the PROGRAM key.	Account Codes	665
2. Press the programmable key that is to be programmed.	Alarm Calls	668
3. Dial the code for the feature (i.e. 616 for divert all calls)	Alarm Call Cancel	669
4. Dial a parameter if required.	Call Park Pick-up	660
5. Press the PROGRAM key to signify the end of programming.	Cancel Call Forward	617
	Cancel Message Waiting	628
	Date Change	656
	Directed Call Pick-up	677
	Directed Message Waiting	673
To program a speed dial key:	Call Forward All to Extension	616
1. Press the PROGRAM key.	Call Forward All to Extension Group	607
2. Press the REDIAL key	Call Forward No Answer or Busy to Extension	620
3. Press the programmable key that is to be programmed.	Call Forward No Answer or Busy to Extension Group	605
4. Dial the speed dial number	Do Not Disturb (DND)	619
5. Press the PROGRAM key to signify the end of programming.	Extension Paging	613
	External Call Waiting	687

To clear a programmed feature from under a key:

1. Press the **PROGRAM** key.
2. Press the programmable key that is to be deleted.
3. Dial the code for delete (603)
4. Press the **PROGRAM** key to signify the end of programming.

To cancel a speed dial key:

1. Press the **PROGRAM** key.
2. Press the REDIAL key
3. Press the **PROGRAM** key to signify the end of programming.

Feature Name	Code
Follow Me	622
Follow Me (I'm Here)	626
Group Call Pick-Up	666
Last Call Cost Display	664
Last Call Duration Display	663
Last Number Redial	600
Message Waiting	643
Night Service Pick-Up	633
Withhold Identity	676
PIN (Personal Identification Number) Codes	634
Recall on Lines	602
Remote Call Forward	688
Time Change	655
Who Am I? Indication	675

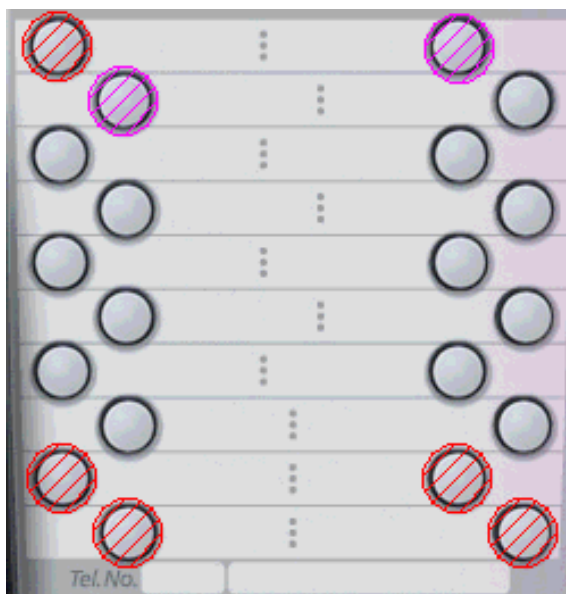

Successful programming using the **PROGRAM** key will result in a normal dial tone. Unsuccessful programming will result in no tone. This may occur when the dial-up code is invalid, the key already has a feature programmed, or an invalid parameter has been dialed.

It is not possible to program any of the pre-programmed keys (such as REDIAL, MESSAGE or TRANS/CONF) as this will result in an error beep. See the image below to illustrate keys that can not be programmed (marked in red). In addition, the keys marked in purple on the image below can not be programmed as SPEED CALL keys although they may be programmed to use other features.



Keys That Can Not Be Programmed

It is possible to program speed dial keys under all the programmable keys and the keypad. It is not possible to program speed dial keys under the fixed function keys or the pre-programmed keys.

-  **Note:** A key must not have an existing feature assigned to it before it can be programmed.
-  **Note:** It is not possible to answer a call while programming a key. It is only possible to program a key when in a free state or off hook (state dial tone). Pressing the Program Key in other states will result in an error beep. The 5005 IP Phone will appear busy when programming a key.

Hold

To place a call on Hold:

- Press **HOLD** and replace the handset in the cradle.

To retrieve a call from Hold:

- Lift the handset.
- Press the LINE key to retrieve the call.

 **Note:** A call placed on hold in this manner is held under the primary line assigned to the set.

 **Note:** This form of hold is a 'System Hold' as any other extension can pick up this held call if they have a DSS/BLF key programmed for the initial holding extension.

Related Topics

Call Store

Exclusive Hold

Call Forward Variations

About Call Forward

Incoming internal and external calls presented at your extension can be forwarded in the following ways:

- Call Forward All (CFA) - forwards all your calls to another extension or extension group without first presenting the calls at your extension.
- Call Forward on No Answer or Busy (CFN/CFB) - forwards your calls to another extension or extension group when you are busy on another call or away from your desk.
- Remote Call Forward - forwards all your incoming calls to an external destination; for example, a cellular phone or your home number.
- Follow Me and Follow Me (I'm Here) - forwards your calls to another extension where you wish to take your calls.

Each type of forwarding can be assigned to one of the programmable function keys and invoked by pressing that key, or by dialing the appropriate feature access code.

 **Note:** To cancel forwarding, dial the **Cancel Call Forward** feature access code, 617. For more information on feature access codes, consult your System Administrator.

You can also forward your calls to voicemail, if available. Contact your System Administrator for the extension number of the voicemail system.

Call Forward All

This feature allows you to forward all your calls to another extension or an extension group without ringing at your extension first. If you always forward your calls to the same extension or extension group, you can program a **CALL FORWARD ALL** key with this number. Alternatively, you can program the **CALL FORWARD ALL** key without specifying a destination number, which means that you must dial an extension or extension group number each time you want to forward your calls. You can setup a number of **CALL FORWARD ALL** keys on your extension, each holding a different destination extension or extension group number.

To forward all of your calls to another extension or extension group:

1. Press the function key that has been programmed for **CALL FORWARD ALL**.
2. If you have not programmed a specific number, enter the number manually to which your calls should be forwarded. *When you lift your handset, you should hear an interrupted dial tone indicating that your calls are being forwarded.*

To cancel forwarding:

1. Press the active **CALL FORWARD ALL** key.
2. When you lift your handset, you should hear a normal dial tone indicating that your calls are no longer being forwarded.

Call Forward No Answer

This feature allows you to forward your calls to a nominated extension or extension group when you are busy on another call or you are unable to answer the call. If you always forward your calls to the same extension or extension group, you can program the **CALL FORWARD NO ANSWER (CFN/CFB)** key with this number. Alternatively, you can program the **CFN/CFB** key without specifying a destination number, which means that you must dial an extension or extension group number each time you want to forward your calls. You can setup a number of **CFN/CFB** keys on your extension, each holding a different extension or extension group number.

To forward your calls to another extension or extension group when your extension is busy or you are unable to answer the call:

1. Press the function key that has been programmed for **CFN/CFB**.
2. If you have not programmed a specific number, enter the number manually to which your calls should be forwarded. *From this point, any calls to your set that are not answered or receive a busy signal will be forwarded to the number you have indicated. When you lift your handset, you should hear an interrupted dial tone indicating that your calls are being forwarded.*

To cancel forwarding:

1. Press the active **CFN/CFB** key.

Call Forward Busy

There are two variations of the **Call Forward Busy** feature:

- **CALL FORWARD BUSY INTERNAL** sends your internal calls to another extension when you are busy on another call.
- **CALL FORWARD BUSY EXTERNAL** sends your external calls to another extension when you are busy on another call.

You can assign either one of these Call Forwarding features to a programmable key but not both to the same key.

 **Note:** When you program this feature through the Desktop Tool, there are two stages. The first is to program the number of the extension that calls will be forwarded to by selecting "**Configure/Activate Call Forwarding**" in the "**I want to...**" list.

To enable or disable **CALL FORWARD BUSY INTERNAL**:

- Press the programmable key assigned to the **CALL FORWARD BUSY INTERNAL** feature.

To enable or disable **CALL FORWARD BUSY EXTERNAL**:

- Press the programmable key assigned to the **CALL FORWARD BUSY EXTERNAL** feature.

Remote Call Forward

This feature allows you to forward your incoming calls to an external destination, for example, a cellular phone or your home number.

 **Note:** This feature is not available at all extensions, please contact your Administrator if you require this feature. Invoking **REMOTE CALL FORWARD** cancels any active internal call forwarding, and vice versa. You cannot store the target external number under a personal key programmed with the **REMOTE CALL FORWARD** feature.

To forward all your calls to an external destination:

1. Press the function key that has been programmed for **REMOTE CALL FORWARD**. When you lift your handset, you should hear interrupted dial tone indicating that you are forwarding your calls.

To cancel **REMOTE CALL FORWARD**:

1. Press the **REMOTE CALL FORWARD** key.

Follow Me

FOLOW ME is similar to the **CALL FORWARD ALL** function but allows you to receive your calls at another extension.

To activate **FOLOW ME**:

1. Before you leave your desk, press the function key programmed for the **FOLOW ME** function.
2. When you are at the extension from which you wish to receive your calls, dial the **FOLLOW ME (I'M HERE)** code followed by the extension number.

 **Note:** Contact your System Administrator for the **FOLLOW ME (I'M HERE)** code.

 **Note:** To be able to activate **FOLLOW ME** from any extension, select "None" instead of a specific extension number when you program the feature.

 **FOLLOW ME** will not function if the "pulled-from" extension does not have the **FOLLOW ME** feature enabled or active.

Call Me Back

CALL ME BACK allows you to request a call back after reaching a busy extension or busy external line. The system monitors the extension or line and calls you when it's free.

To request a callback when you reach a busy or unanswered telephone:

1. Wait until you hear a busy signal when making a call.
2. Press the **CALL ME BACK** key.

To answer a callback:

1. Lift the handset.

Camp-On

CAMP-ON, or **CALL WAITING**, lets you notify someone who is using a telephone that you are waiting to be connected. An attendant may also camp a call onto a busy station. Upon hearing the **CAMP-ON** tone, the busy party can either respond or finish the current call.

To **CAMP-ON** to a busy station:

- Press the programmable key assigned to the **CAMP-ON** feature when you hear the busy signal.

To retrieve a call when you hear a **CAMP-ON** tone:

- Press the programmable key assigned to the **CAMP-ON** feature.

Cancel

The Cancel key is a fixed-function key that allows you to cancel the current operation and return to a dial tone. Pressing this key is equivalent to replacing your handset and lifting it up again. When this key is pressed during programming, you are returned to the previous programming step.

Pressing the Cancel key will reconnect the user to the original active call if the user is in the middle of a Transfer.

Line Keys

The top-left programmable function key on your set will automatically be programmed as a **LINE** key (referred to as either an 'intercom' or 'Prime Line' key). Additional programmable keys can be set up to access other lines so that you can answer or make calls on multiple lines.

Programmable keys designated as **LINE** keys will indicate the status of a line with the key light as follows:

Key Status	Explanation
Lit	The line is in use.
Unlit	The line is idle (or free).
Flashing with ringing cadence	An external call is ringing on this line.
Flashing with held cadence	A call on this line is currently on hold.

To program an additional **LINE** key:

1. Press the PROGRAM key.
2. Press the programmable key to be used for an additional line.
3. Dial 9 followed by the line number. *For example, 001, to use Line 1.*
4. Press the PROGRAM key once again. *The programmable key will now be set to use Line 1.*

To make a call using a line other than the primary one assigned to the set:

1. Lift the handset.
2. Press a line key that has been programmed to use another extension.
3. Dial the number.

 **Note:** Refer to Making And Answering Calls for further information.

Message

If the message indicator is flashing slowly while the phone is not ringing, this indicates that you have a message or voicemail.

 **Note:** For voicemail to work properly with the 5005 IP phone, Call Forwarding must be activated on the set. Refer to ICP technical documentation for further information.

The response to a message indication changes depending on whether the caller wants you to call back or if they have left a voice message.

To respond to a message indication:

- Lift the handset.
- Press **MESSAGE**.
- If the caller has left a voice message, the phone will automatically call the voicemail system.
OR
- If the caller has activated your message indicator instead of leaving a voice message, the phone will automatically call their number.

When you call another extension and your call is unanswered or the called extension is busy, you can leave a message waiting indication to alert the user to return your call. The called extension user is informed of the message waiting indication by their Message Indicator flashing and the display screen showing "MESSAGE WAITING". The Message Indicator and display message at the target extension are removed when a connection is established between you and the called extension.

 **Note:** You cannot leave a message waiting indicator at an extension which already has a message waiting from another extension user; you will hear a re-order tone.

If you have left a message waiting indication at another user's extension and wish to cancel it, you can do so via the pre-programmed Cancel Message Waiting key.

Redial

To redial the last number you called:

- Lift the handset.
- Press **REDIAL** twice.

 **Note:** You can not redial a call that was made using a programmable function key.

Transferring And Conferencing

Transfer

To Transfer an active call:

- While in conversation with an established call, press **TRANS/CONF**.
- Dial the number of the third party.
- Do one of the following:
 - To complete the Transfer, hang up.
 - To announce the Transfer, wait for an answer, consult, and hang up.

To cancel a Transfer before the third party has been connected:

- Press the CANCEL key to be reconnected to the original active call.

Conference

To form a Conference when a two-party call is already in place, or to add another party to an existing Conference:

- Press TRANS/CONF.
- Dial the number of the next party.
- Wait for an answer.
- Press TRANS/CONF.

 **Note:** The display screen will display "3 PARTY CONF" during a Conference call.
To leave a Conference:

- Hang up.

Account Code

ACCOUNT CODE assigns a code to a call, usually for accounting purposes. The code identifies the account in the call records that your system generates. You can program an **ACCOUNT CODE** key with or without a specific account code. Specifying the account code saves you from having to dial it every time you want to log a call.

To allocate an account code to an outgoing call if you have programmed an **ACCOUNT CODE** key:

1. Press the programmable key assigned to the **ACCOUNT CODE** feature.
2. Access a line and dial the external number.

 **Note:** Contact your System Administrator for a list of account codes.

Advisory Messages

You can program your extension to display a message at a calling extension; the message remains on the calling extension's LCD for the duration of ringing and is cleared when the caller hangs up or you answer the call.

Msg. No.	Message
1	Away Sick
2	Away on Holiday
3	Back Tomorrow/Monday...Sunday
4	Back AM/11am...1am
5	Gone To Lunch
6	Back PM/1pm...Midnight
7	Gone Home
8	Please Call Back
9	Busy in Meeting
*	Back Soon
0	No Calls Please
#	Away on Business

To activate **Advisory Messages**:

1. Press the **PROGRAM** key.
2. Press the key on the numeric keypad corresponding to the appropriate message.
3. Press the **PROGRAM** key again. *The Advisory Message is displayed immediately.*

To deactivate Advisory Messages:

1. Press the **PROGRAM** key twice. The date will then return to the display screen.

Answer Variations

Answer External Call

If you want to answer external calls in the order that they arrive at your extension, you need to program an **ANSWER EXTERNAL** key. You answer the incoming call by pressing the flashing, pre-programmed **ANSWER EXTERNAL** key. The **ANSWER EXTERNAL** key continues to flash until all incoming external calls have been answered.

To answer external calls using the **ANSWER EXTERNAL** key:

1. Press the flashing **ANSWER EXTERNAL** key. The **ANSWER EXTERNAL** key continues to flash until all the incoming external calls have been answered.

Answer Next Call

This feature is similar to Answer External Call, however, it applies to all incoming internal and external calls. Answer Next Call allows you to answer all calls in the order that they are presented at your extension. You answer the incoming call by pressing the flashing, pre-programmed **ANSWER NEXT CALL** key. The **ANSWER NEXT CALL** key continues to flash until you have answered all the calls.

To answer internal and external calls in the order that they are presented at your extension:

- Press the flashing **ANSWER NEXT CALL** key. The **ANSWER NEXT CALL** key continues to flash until all incoming calls have been answered.

Auto-Answer

AUTO-ANSWER lets you answer calls without lifting the handset. When a call arrives, you hear a short ring, followed by the caller's voice.

To enable or disable **AUTO-ANSWER**:

- Press the programmable key assigned to the **AUTO-ANSWER** feature.

To answer a call while on **AUTO-ANSWER**:

- Lift the handset.

Calls For

This feature identifies the extension number of a user who has forwarded calls to your extension. When a forwarded call is presented at your extension, the **CALLS FOR** key flashes and your display screen temporarily displays who the call was originally intended for. Press the **CALLS FOR** key to answer the call (with the appropriate greeting). If a number of extension users forward their calls to you regularly, you can program a **CALLS FOR** key for each extension.

 **Note:** The **CALLS FOR** key should be labeled with the name or number of the forwarding extension.

To answer a call forwarded from another extension:

1. Press the flashing **CALLS FOR** key.

Call Park

CALL PARK places an external call on hold for pick up by any extension in the system. **CALL PARK** is similar to **HOLD** except that you use a different key. You also do not need a special key to retrieve the held call as you can use a feature access code. Multiple calls can be placed on hold using **CALL PARK**.

To place a call on **CALL PARK**:

1. Press the function key that has been programmed for **CALL PARK**.

To retrieve a call that has been parked:

1. Lift the handset.
2. Dial the **CALL PARK** pick-up code followed by the number of the line on which the call is parked. *Your display screen shows the number of the line that the call is parked on.*

Note: Consult your System Administrator for specific function codes.

Call Pickup

CALL PICK-UP allows you to answer a call that is ringing at another extension in your pick-up group. Your System Administrator assigns membership in a pick-up group.

To answer a call that is ringing at another station in your pick-up group:

1. Lift the handset.
2. Press the programmable key assigned to the **CALL PICK-UP** feature.

Cancel Message Waiting

If you have left a message waiting indication at another user's extension and wish to cancel it, you can do so via the pre-programmed **CANCEL MESSAGE** key.

To cancel a Message Waiting indication using a **CANCEL MESSAGE** key which does not include an extension number:

1. Press the **CANCEL MESSAGE** key.
2. Dial the extension number of the called extension or press the relevant **DSS/BLF** key.

To cancel a Message Waiting indication using a **CANCEL MESSAGE** key which is programmed with an extension number:

1. Press the **CANCEL MESSAGE** key.

Do Not Disturb

When **DO NOT DISTURB** is on, your phone will not ring when you get a call. Extension users that call you will hear a busy tone; external callers will hear ringing.

To activate or deactivate **DO NOT DISTURB**:

1. Press the programmable key assigned to the **DO NOT DISTURB** feature.

 Note: "DO NOT DISTURB" will appear in the display screen.

Direct Station Selection/Busy Lamp Field (DSS/BLF)

A **DSS/BLF** (Direct Station Selection/Busy Lamp Field) key allows you to call another extension user with a single key press. It also allows you to pick up calls to a specified extension or retrieve calls that have been held at the specified extension.

The **DSS/BLF** key lights to indicate the status of the extension:

Key Status	Explanation
Lit	Programmed extension is busy, off-hook, or has set Do Not Disturb.
Unlit	The extension is idle.
Flashing with ringing cadence	Programmed extension is ringing and the call can be picked up by the extension with the DSS/BLF key.
Flashing with held cadence	Programmed extension has placed a call on System Hold and the call can be picked up.

To call a pre-programmed extension:

1. Lift the handset.
2. Press the programmable key assigned to the **DSS/BLF** feature.

To pick up a call to a pre-programmed extension:

1. When the **DSS/BLF** key is flashing with ringing cadence, lift the handset.
2. Press the programmable key assigned to the **DSS/BLF** feature.

To retrieve a call that has been held by a pre-programmed extension:

1. When the **DSS/BLF** key is flashing with held cadence, lift the handset.
2. Press the programmable key assigned to the **DSS/BLF** feature.

Extension Group

An **EXTENSION GROUP** key allows you to call an extension group with a single key. Membership of an extension group is set up by your System Administrator (and can be, for example, all members of the Sales Department). When an extension group is called, all extensions in the group ring until the call is answered.

Contact your System Administrator for a list of extension group numbers.

The status of an extension group is indicated by the **EXTENSION GROUP** key light as follows:

Key Status	Explanation
Lit	All extensions in the extension group are busy.
Unlit	At least one extension in the extension group is idle.
Flashing	Extension group is ringing.

To call an extension group:

1. Lift the handset.
2. Press the programmable key assigned to the **EXTENSION GROUP** feature.

Extension Paging

EXTENSION PAGING allows you to make an announcement through an extension's speaker. You can program a key to page a single extension, an extension group, or all extensions effectively turning the telephone system into an intercom.

To use **EXTENSION PAGING**:

1. Lift the handset.
2. Press the programmable key assigned to the **EXTENSION PAGING** feature.
3. Dial the extension number or the paging zone number (if applicable).
4. Make the announcement.
5. Replace the handset to complete the page.

Group Listen

During a handset call, this feature turns on your extension's speaker to allow others nearby to listen to your current call while your handset microphone remains on allowing you to speak to the other person.

To activate your extension's speaker during a call:

1. Press the **GROUP LISTEN** key. The **GROUP LISTEN** key lights solid when the loudspeaker is enabled and the following message is displayed: "GROUP LISTEN".

To de-activate your extension's speaker:

1. Press the **GROUP LISTEN** key again. The **GROUP LISTEN** key extinguishes and the display screen returns to normal.

Hold Variations

Call Store

This feature allows you to place an external call on hold under a key and leave it on hold for a pre-defined time.

 **Note:** Only external calls may be held using this feature.

 **Note:** The number of **STORE** keys that you can have programmed at your extension is limited by the number of available personal keys to a maximum of thirty (30).

 **Note:** A stored call cannot be picked by another extension user and you cannot transfer the stored call to another extension.

To store a call:

1. While in conversation with another party, press a **STORE** key.

To retrieve a call that has been stored:

1. While your extension is idle, press the flashing **STORE** key.

Exclusive Hold

EXCLUSIVE HOLD places a call on hold that may only be retrieved from the originating set. This type of hold allows you to place a single party on hold if you do not have any dedicated LINE or DSS/BLF keys on your set. If you do have dedicated LINE or DSS/BLF keys, a number of parties can be placed on Exclusive Hold.

To place a call on exclusive hold to make an enquiry call or answer another call:

- While in conversation with an established call, press the **EXCLUSIVE HOLD** key. The current call is placed on hold. Any DSS/BLF or LINE keys associated with the call will flash with held cadence.

To retrieve a call from exclusive hold that is not associated with a DSS/BLF or LINE key:

- Press the **EXCLUSIVE HOLD** key. You are re-connected to the held party.

To retrieve a call from exclusive hold that is associated with a DSS/BLF or LINE key:

- Press the flashing DSS/BLF or LINE key. You are re-connected to the held party.

Last Call Duration Display

This feature enables the duration of the last external call that was made from your extension to be displayed on your set's display screen. The duration of the current call is dynamically displayed during the call.

To display the duration of the last external call:

1. While your extension is idle, press the **CALL DURATION** key.

Line Group

A **LINE GROUP** key allows you to access and answer calls from a specified line group with a single key.

The **LINE GROUP** key light indicates the status of a line group:

Status	Explanation
Lit	All lines in the line group are busy.
Unlit	At least one line in the line group is idle.
Flashing	Line group is ringing.

To make a call using a line group:

1. Lift the handset.
2. Press the programmable key assigned to the **LINE GROUP** feature.
3. Dial the number or press a Speed Call key to dial a pre-programmed number.

To answer a call on a line group:

1. When the **LINE GROUP** key is flashing, lift the handset.
2. Press the programmable key assigned to the **LINE GROUP** feature.

Locking/Unlocking The Phone

Your System Administrator can assign a PIN (Personal Identification Number) code to you which, when invoked, prevents unauthorized users from making external calls from your telephone. That is, it locks your extension to prevent unauthorized use. You can also use your PIN code at another extension to access features or make external calls which would not normally be available from that extension.

 **Note:** You can still make internal calls and dial emergency numbers from a locked extension.

To lock your extension:

1. While your extension is idle, press the programmable key assigned to the **PIN CODE** feature.
2. Dial your PIN code. If programmed, the **PIN CODE** key lights solid indicating that your extension is locked.
3. Replace your handset.

To unlock your extension:

1. While your extension is idle, press the programmable key assigned to the **PIN CODE** feature.
2. Dial your PIN code. If programmed, your **PIN CODE** key extinguishes.
3. Replace your handset.

To make an external call from another user's locked extension:

1. While the extension is idle, press the programmable key assigned to the **PIN CODE** feature.
2. Dial your PIN code.
3. Access a line and dial the required external number.
4. At the end of the call, replace your handset. *This extension remains unlocked for 60 seconds (default) allowing you to make further calls if required, after this time the extension returns to its locked state.*

Night Service

About Night Service

Placing the system into Night Service mode is only available from an Administrator Extension, however, an extension user can setup a **NIGHT SERVICE** key at their extension to monitor whether the system is in Day or Night Service mode.

Two night service modes are available: Night Service 1 and 2. An Administrator can setup the system to direct incoming calls to an extension or a number of extensions which will be answered outside of regular working hours.

Each Night Service mode has an associated pick-up group, and when a night service mode is operating, incoming calls can be picked up by any extension user in the group. Refer to Night Service Pick-up.

To monitor whether the system is in Day or Night Service mode:

1. When the system moves into Night Service 1 or 2 mode the programmed **NIGHT SERVICE 1** or **NIGHT SERVICE 2** key lights and the following message is displayed: **NIGHT SERVICE x**, where x indicates the Night Service mode.

Night Service Pick-up

When Night Service is active, this feature allows you to pick up an incoming external call which is ringing at another extension in your Night Service Pick-up group.

 **Note:** Your System Administrator can set up the system so that a single-digit can be used to pick-up the call instead of using the three-digit access code. Contact your System Administrator for a list of single-digit access codes.

To answer a call that is ringing at another extension in your Night Service Pick-up group:

- Press the **NIGHT SERV PICKUP** key, or dial the Call Pick-up single-digit access code. *You are connected to the caller of the ringing extension.*

Re-establish

If an external call you have transferred to another extension user is unanswered, the call returns to your extension. This feature allows you to re-attempt the transfer. When the returned call rings at your extension, the associated key flashes with rapid cadence and a message similar to the following is displayed: "EXTN xxxx REVERTED".

To re-establish a returned call without speaking to the caller:

1. Press the **RE-ESTABLISH** key.

To speak to the caller of the returned call and re-establish the call:

1. Lift your handset.
2. Speak to the caller. *The **RE-ESTABLISH** key lights solid.*
3. Press the **RE-ESTABLISH** key.
4. Replace your handset.

Ringer On/Off

All incoming external calls that arrive at your extension under programmed personal keys ring to indicate the arrival of the call. This feature allows you to turn off your extension's ringer. All external calls that arrive at your extension, under a programmed personal key, will be indicated by the key flashing. The keys affected by this feature are:

- LINE key;
- LINE GROUP key
- CALLS FOR key;
- ANSWER EXTERNAL key
- ANSWER NEXT CALL key.

 **Note:** You will not be able to use the Ringer On/Off feature unless one of the features listed above has previously been programmed into one of the function keys on the telephone.

To turn the Ringer off or on:

1. Press the **RINGER ON/OFF** key. The **RINGER ON/OFF** key lights solid and "RINGER OFF" is displayed indicating that your extension does not ring when an external call arrives.

Repeatedly pressing the **RINGER ON/OFF** key toggles between switching your extension's Ringer on and off.

Speed Call

You may use Speed Call keys to make a call or to send a string of digits during a call (press a Speed Call Key during a call to send a multi-digit password, for instance).

To dial a stored Speed Call number:

1. Lift the handset.
2. Press the key programmed for the Speed Call number you wish to dial.

To use a stored Speed Call number during a call:

1. Make a call as per the usual procedure for making and answering calls.
2. When you need to enter the pre-programmed number you have already stored, press the key programmed for the Speed Call number you wish to be transmitted.

 **Note:** Speed call numbers are stored as detailed in the **Programming The Function Keys** topic.

Swap

SWAP allows you to alternate between two calls by pressing a key. Each call is kept private as neither person can overhear your conversation with the other.

To use the **SWAP** feature to alternate between calls:

1. Make or answer a call, consult and then press the **SWAP** key to place that call on hold.
2. While the first call is on hold, make or answer a second call.
3. Press the programmable key assigned to the **SWAP** feature to alternate back and forth between the two calls.

 **Note:** This feature may only be available on this set provided that Exclusive Hold has already been activated. Consult your System Administrator for more information.

Index

1

10/100BaseT Ethernet 2

A

Account Code 18

Adjusting 5

Display Contrast 5

 Handset Receiver Volume 5

 Ringer Volume 5

 Volume Levels 5

Advisory Messages 19

Answer External Call 19

Answer Next Call 19

Auto-Answer 20

B

Busy Lamp Field/Direct Station Selection 21

C

Call Forward 6, 13

 Call Forward All 14

 Call Forward Busy 14

 Cancel Call Forward 13

Call Me Back 16

Call Park 20

Call Pickup 20

Call Store 23

Calls For 20

Camp-On 16

Cancel 16

CFN/CFB 14

Conference 18

D

Desktop Stand 7

Desktop Tool 6, 11

DO NOT DISTURB 21

DSS/BLF 21, 23

E

Exclusive Hold 23

Extension Group 22

F

Follow Me.....15

G**Group Listen**.....22**H****Hold**13, 20**L****Last Call Duration Display**24**Locking/Unlocking The Phone**24**M****Message**.....17**Message Waiting**.....21**Mitel Networks 3100 Integrated Communications Platform**2, 3, 4, 9**Mitel Networks 3300 Integrated Communications Platform**2

Mitel Networks Corporation.....1

Mounting8

On The Wall Using Screws8

On The Wall Using The Desktop Stand8

N

Night Service.....25

Night Service Pick-up.....25

Notices3**Numeric Keypad**.....2**P****Paging**22**Personal Identification Number**.....24**PIN**24**Prime Line key**.....2, 24**Program Key**.....11**Programmable Function Keys**.....2**R****Redial**17**Re-establish**.....26**Register**.....4

Remote Call Forward15

Ringer On/Off.....26

S

Safety 3
Speed Call 11, 26
Swap 27
System Administrator 4, 6, 13, 15, 18, 20, 24, 25, 27

T

Telephone Status Indicators 4
TRANS/CONF 9, 18
Transfer 18
 announce 18
 cancel 18
 complete 18

V

Voicemail 13, 14, 17
Volume Control 2