

MITEL

5 2 0 7 | **IP Phone**

USER GUIDE



 **MITEL** | it's about **YOU**

Contents

ABOUT YOUR PHONE	1
TIPS FOR YOUR COMFORT AND SAFETY	2
Don't cradle handset!	2
Protect your hearing	3
Using a headset	3
Adjusting the viewing angle.....	3
CUSTOMIZING YOUR SET	4
Ringer Control	4
Handset Receiver Volume Control.....	4
Speaker Volume Control.....	5
Display Contrast Control	5
Feature Keys	5
Language Change.....	5
MAKING AND ANSWERING CALLS.....	6
Make a Call - PBX.....	6
Make an External Call - KTS	6
Make an Intercom Call - KTS	6
Answer a Call.....	7
Redial	7
Speed Call Keys	8
Speed Call - Personal.....	9
Auto-Answer.....	9
Handsfree Operation.....	10
CALL HANDLING.....	11
Hold	11
Hold and Page	11
Transfer	12
Conference.....	12
Swap	12
Call Forward	13
Call Forward (Enhanced)	14
Call Forward (No Internal/External Split).....	16
Call Forward (No Internal/External Split - Enhanced)	17
Call Forward - I'm Here.....	18
Call Forward - Forced.....	19
Call Forward - Toggle.....	19
Messaging - Advisory	20
Messaging - Callback	20

USING ADVANCED FEATURES	21
Account Codes	21
Callback	21
Call Park	22
Call Park - System.....	23
Call Park - Specific Orbit	24
Call Pickup	24
Call Park - Destination Phone.....	25
Campon	25
Do Not Disturb.....	25
Override (Intrude).....	26
Paging - PA	26
Paging - Direct.....	27
Paging - All Set.....	27
Paging - Group	28
Handset Mute	28
Direct Station Select/Busy Lamp Field (DSS/BLF)	28
DSS/BLF/Call Pickup	29
Direct Page/BLF	29
DSS/BLF/Direct Page/Call Pickup.....	29
Park and Page.....	30
Record a Call	33
Reminder	33
Reminder - Multiple	34
Music.....	34
Phonebook	35
Call Monitoring.....	36
Door Opener.....	37
Night/Day Service Switching	38

ABOUT YOUR PHONE

The 5207 IP Phone has eight fixed-function keys (**SUPERKEY, HOLD, TRANS/CONF, CANCEL, REDIAL, SPEAKER, MESSAGE, MICROPHONE**,  and ) and 14 personal keys with built-in status indicators. The personal key on the bottom right is always your Prime Line; the remaining personal keys can be programmed as:

- Feature keys (for example, **Swap**). You can program feature keys from your phone. Your administrator can also program feature keys.
- Speed Call keys. You can program speed call keys from your phone.
- Line Appearances. Only the administrator can program line appearances.

Your telephone also features display-assisted selection of features, on-hook dialing, and a large Message Indicator.

Note: When using the **SUPERKEY**, press **Cancel** to back up one menu level.

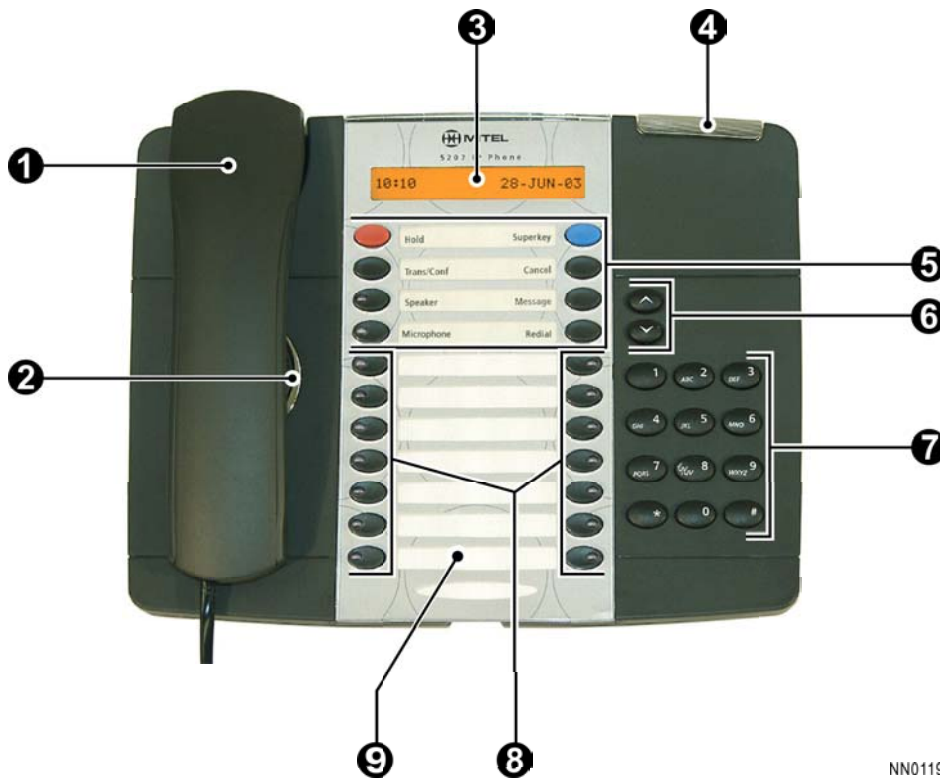

NN0116

Phone buttons

1. Handset
2. Speaker
3. Display
4. Message Waiting Indicator
5. Fixed-Function Keys
6. Volume Control
7. Keypad
8. Programmable Feature Keys
9. Designation Card

Line status indicators

When line is	the indicator is
Idle	Off
Busy	On (red)
Ringing	Flashing slowly (red)
On hold at your set	Flashing rapidly (green)
On hold at another set	Flashing slow on/fast off (green)

Designation Card

Write the name of the feature keys on the designation card (use the side of the card without arrows). Use the slot behind the plastic cover at the bottom of the phone to remove/insert the designation card.

TIPS FOR YOUR COMFORT AND SAFETY

Don't cradle the handset!

Prolonged use of the handset can lead to neck, shoulder, or back discomfort, especially if you cradle the handset between your ear and shoulder.

Protect your hearing

Your phone has a control for adjusting the volume of the handset receiver. Because continuous exposure to loud sounds can contribute to hearing loss, keep the volume at a moderate level.

Using a headset

5207 IP Phones DO NOT support the direct connection of a headset. Use of a headset with this phone requires a Plantronics M12 Vista Universal Amplifier. The amplifier plugs into the handset port on the underside of the phone. Follow all instructions in the Plantronics M12 Vista documentation for proper installation and use.

Plantronics models P51, P81, P101N, and Supra NC headsets are the ONLY headsets approved for use with the 5207 IP Phone through the Plantronics M12 Vista. For optimum audio quality, set the M12 volume control to a low setting (1 to 3).

CAUTION: Using a headset without the required amplifier may cause hearing damage.

Adjusting the viewing angle

To tilt your telephone for better viewing:

1. Press the release tabs on the sides of the stand.
2. Hinge the two front hooks and snap the two back hooks of the stand into either the upper or lower notches on the back of the phone.

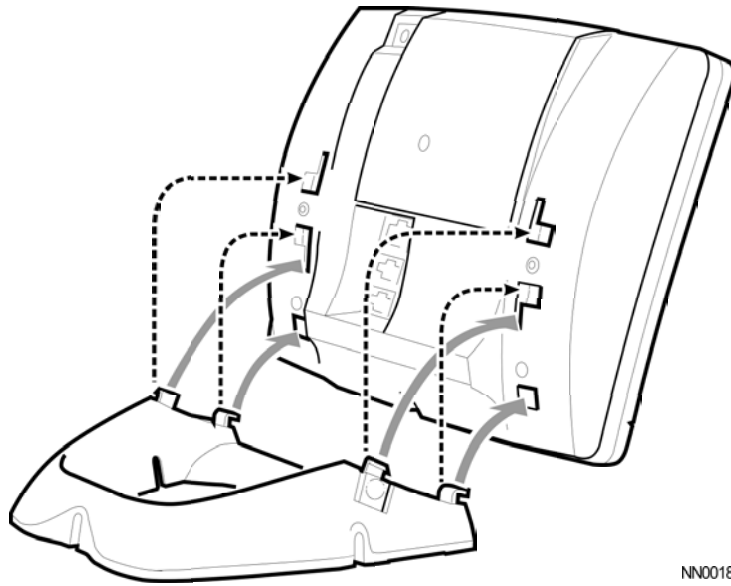

NN0018



CUSTOMIZING YOUR PHONE

Ringer Control

To adjust the Ringer Volume while the set is ringing:

- Press  or .

To adjust the Ringer Pitch while the set is idle:

1. Press **SUPERKEY**.
2. Press **#** until "Ringer Adjust?" appears.
3. Press ***for Yes**.
4. Press ***** to adjust the ringer pitch.
5. Press  or .
6. Press **#** to save.
7. Press **SUPERKEY**.

Handset Receiver Volume Control

To adjust the Handset Receiver Volume when you are using the handset:

- Press  or .

Speaker Volume Control

To adjust the Speaker Volume when making an on-hook call or when listening to background music:

- Press  or .

Display Contrast Control

To adjust the Display Contrast while your set is idle:

- Press  or .

Feature Keys

To display information about a key:

1. Press **SUPERKEY**.
2. Press a personal key.
3. Press **SUPERKEY**.

To program a feature key:

1. Press **SUPERKEY**.
2. Press **#** until "Personal Keys?" appears.
3. Press ***** for Yes.
4. Press a personal key that isn't a line key.
5. Press ***** for Change.
6. Press **#** until the desired feature appears.
7. Press ***** for Yes.
8. Press **SUPERKEY**.

Language Change

To change the display language:

1. Press **SUPERKEY**.
2. Press **#** until "Language?" appears.
3. Press ***** for Yes.
4. Press ***** to change the language.
5. Press **#** until the desired language appears.
6. Press ***** to save your selection.

MAKING AND ANSWERING CALLS

If your telephone system operates as a PBX, the Prime Line can be used for both incoming and outgoing calls. Outgoing calls require dialing a line access code (usually "9") followed by the telephone number.

In a key telephone system (KTS), the Prime Line is used for internal (Intercom) calls only. Outgoing calls require the use of Line keys.

Make a Call - PBX

1. Lift the handset.
2. Dial the extension number or a line access code (usually "9") and the telephone number for an outside call.
-OR-
Press a Speed Call key.

Make an External Call - KTS

1. Lift the handset.
2. Press a Line key.
3. Dial the telephone number.
-OR-
Press a Speed Call key.
-OR-
Press **REDIAL**.

Make an Intercom Call - KTS

An Intercom call is a call between two extensions, which either pages or rings the called extension.

To switch between a ringing intercom call to a paged intercom call:

1. Make a call.
2. Do one of the following while listening to ringback tone:
 - Press the **Direct Page** feature key.
 - Dial ***48**.

Answer a Call

- Lift the handset.

-OR-

Press the flashing Line Appearance key and lift the handset.

Note: The Auto-Latch Microphone feature described elsewhere in this guide allows you to answer and respond to internal calls handsfree.

Redial

To redial the last number that you manually dialed:

1. Lift the handset.
2. Press **REDIAL**.

Speed Call Keys

You may use Speed Call Keys to make a call or to send a string of digits during a call (press a Speed Call Key during a call to send a multi-digit password, for instance).

To dial a stored Speed Call number:

1. Lift the handset.
2. Press a Speed Call key.

To store a Speed Call number:

1. Press **SUPERKEY**.
2. Press **#** until "Personal Keys?" appears.
3. Press ***** for Yes.
4. Press a personal key that isn't a line key.
5. Press ***** to change the speed call number.
6. Do one of the following:
 - To store a new number, enter "9" or other digit(s) used to access an outside line (if required) followed by enter the telephone number. Press **HOLD** between digits to create a one-second pause during dialing - press **HOLD** more than once to lengthen the pause).
 - To enter the last number dialed, press **REDIAL**.
7. Press the personal key again.
8. Do one of the following:
 - To make the number private, press *****.
 - To keep the number visible, press **#**.
9. Press **SUPERKEY**.

Speed Call - Personal

To dial a stored personal Speed Call number:

1. Lift the handset.
2. Dial ***52**.
3. Enter an index number between **1** and **5**.

To store a personal Speed Call number:

1. Lift the handset.
2. Dial ***51**.
3. Enter an index number between **1** and **5**.
4. Enter "9" or other digit(s) used to access an outside line (if required) followed by enter the telephone number.
Press **HOLD** between digits to create a one-second pause during dialing - press **HOLD** more than once to lengthen the pause).
5. Hang up.

Auto-Answer

To answer a call when you hear ringback:

- Communicate using the speaker and the microphone.

To terminate a call:

- Press **CANCEL**.
-OR-
Wait for the caller to hang up.

Handsfree Operation

To use Handsfree Operation to make calls:

1. If you want to use a Non-Prime Line, press a Line Appearance key.
2. Dial the number.
3. Communicate by using the speaker and the microphone.

To use Handsfree Operation to answer calls:

1. Press the flashing line key.
2. Communicate by using the speaker and the microphone.

To hang up while using Handsfree Operation:

- Press **SPEAKER**.

To temporarily disable the microphone during a Handsfree conversation:

- Press **MICROPHONE** (the microphone LED turns off).

To re-enable the microphone and return to the conversation:

- Press **MICROPHONE** (the microphone LED turns on).

To disable Handsfree Operation:

- Lift the handset.

To return to Handsfree Operation:

1. Press **SPEAKER**.
2. Hang up.

CALL HANDLING

Hold

To place a call on Hold:

- Press **HOLD**.

To retrieve a call from Hold:

1. Lift the handset.
2. Press the flashing line key.

To retrieve a call from Hold at another station:

1. Press the flashing line key.
-OR-
2. Dial ***23** and the number of the station that placed the call on Hold.

Hold and Page

The Hold and Page feature allows you to put a call on hold and page without having to use a feature key or code. You can also page after parking a call; see Call Park - Specific Orbit.

To place a call on hold and page:

1. Press the red **HOLD** key twice.
2. Make the page.

To place a call on hold and not page:

1. Press the red **HOLD** key.
2. Press any key except for the red **HOLD** key. The call is on hold.

Transfer

To Transfer an active call:

1. Press **TRANS/CONF**.
2. Dial the number of the third party.
3. Do one of the following:
 - To complete the Transfer, hang up.
 - To announce the Transfer, wait for an answer, consult, and hang up.
 - To cancel the Transfer, press **CANCEL**.

Conference

To form a Conference when a two-party call is already in place, or to add another party to an existing Conference:

1. Press **TRANS/CONF**.
2. Dial the number of the next party
3. Wait for an answer.
4. Press **TRANS/CONF**.

To leave a Conference:

- Hang up.

Swap

To call another party when you are in an established two-party call:

1. Press **TRANS/CONF**.
2. Dial the number.

To alternate between the two parties:

- Press the **Swap/Trade** feature key.
Note: For information on programming a feature key, see "Feature Keys" elsewhere in this guide.

Call Forward

Call Forward lets you redirect incoming calls to an alternate number. "External Calls?" redirects your incoming external calls only; "Internal Calls?" redirects your incoming internal calls only. If you want to redirect both external and internal calls, you must program each separately.

"Always Forward?" redirects all incoming calls regardless of the state of your telephone. "When No Answer?" redirects calls after several rings if you don't answer. "When Set's Busy?" redirects calls when your telephone is busy. "Busy/No Answer?" redirects calls when your telephone is busy or when you don't answer.

Note: For information about "I'm Here?", see Call Forward - I'm Here.

To program Call Forward:

1. Press **SUPERKEY**.
2. Press **#** until "Call Forwarding?" appears.
3. Press ***** for Yes.
4. Do one of the following:
 - To program external forwarding, press *****.
 - To program internal forwarding, press **#** and press *****.
5. Press **#** until the desired type of Call Forward appears.
6. Press ***** for program Call Forward.
7. Dial the destination number.
8. Press  to save.
9. Press **SUPERKEY** to exit.

To turn Call Forward on and off (once it has been programmed):

1. Press **SUPERKEY**.
2. Press **#** until "Call Forwarding?" appears.
3. Press ***** for Yes.
4. Do one of the following:
 - To program external forwarding, press *****.
 - To program internal forwarding, press **#**.
5. To turn call forwarding on or off, press *****, and then **#**.
6. Continue turning other types of call forwarding on or off or press **SUPERKEY** to exit.

Call Forward (Enhanced)

Call Forward lets you redirect incoming calls to an alternate number. "External Calls?" redirects your incoming external calls only; "Internal Calls?" redirects your incoming internal calls only. If you want to redirect both external and internal calls, you must program each separately.

"Always Forward?" redirects all incoming calls regardless of the state of your telephone. "When No Answer?" redirects calls after several rings if you don't answer. "When Set's Busy?" redirects calls when your telephone is busy. "Busy/No Answer?" redirects calls when your telephone is busy or when you don't answer.

Note: For information about "I'm Here?", see Call Forward - I'm Here.

To program Call Forward:

1. Press **SUPERKEY**.
2. Press the **#** until "Call Forwarding?" appears.
3. Press ***** for Yes.
4. Do one of the following:
 - To program external forwarding, press *****.
 - To program internal forwarding, press **#**.An asterisk next to External Calls? or Internal Calls? indicates that at least one type of call forwarding is turned on.
5. Press ***** to program Call Forward Always or **#** to program another type of call forward.
Press ***** to start programming.
6. Dial the destination number.
7. Press .
8. Continue programming other types of Call Forward, or press **SUPERKEY** to leave programming mode.

To turn Call Forward on and off (once it has been programmed):

1. Press **SUPERKEY**.
2. Press **#** until "Call Forwarding?" appears.
3. Press ***** for Yes.
4. Do one of the following:
 - For external forwarding, press *****.
 - For internal forwarding, press **#**.
5. Do one of the following:
 - To turn Call Forward Always on or off, press *****, and then **#**.
 - To turn another type of Call Forward on or off, press **#** until you reach the desired display, and then press ***** followed by **#**.
6. Continue turning other types of Call Forward on or off or press **SUPERKEY** to leave programming mode.

Call Forward (No Internal/External Split)

Call Forward lets you redirect incoming calls to an alternate number. "Always Forward?" redirects all incoming calls regardless of the state of your telephone. "When No Answer?" redirects calls after several rings if you don't answer. "When Set's Busy?" redirects calls when your telephone is busy. "Busy/No Answer?" redirects calls when your telephone is busy or when you don't answer.

Note: For information about "I'm Here?", see Call Forward - I'm Here.

To program Call Forward:

1. Press **SUPERKEY**.
2. Press **#** until "Call Forwarding?" appears.
3. Press ***** for Yes.
4. Press ***** for external call forwarding.
5. Press **#** until the desired type of Call Forward appears.
6. Press ***** to change call forwarding if it is already programmed, and then press ***** to program.
7. Dial the destination number.
8. Press **⏏** to save.
9. Press **SUPERKEY** to exit.

To turn Call Forward on and off (once it has been programmed):

1. Press **SUPERKEY**.
2. Press **#** until "Call Forwarding?" appears.
3. Press ***** for Yes, and then press ***** for external call forwarding.
4. To turn call forwarding on or off, press *****, and then press **#**.
5. Press **SUPERKEY** to exit.

Call Forward (No Internal/External Split - Enhanced)

Call Forward lets you redirect incoming calls to an alternate number. "Always Forward?" redirects all incoming calls regardless of the state of your telephone. "When No Answer?" redirects calls after several rings if you don't answer. "When Set's Busy?" redirects calls when your telephone is busy. "Busy/No Answer?" redirects calls when your telephone is busy or when you don't answer.

Note: For information about "I'm Here?", see Call Forward - I'm Here.

To program Call Forward:

1. Press **SUPERKEY**.
2. Press **#** until "Call Forwarding?" appears.
3. Press ***** for Yes.
4. Press ***** to program Call Forward Always or **#** to program another type of call forward.
An asterisk next to the Call Forward destination indicates that call forwarding is turned on.
5. Press ***** to program Call Forward.
6. Dial the destination number.
7. Press **⏺** to save.
8. Continue turning other types of Call Forward on or off or press **SUPERKEY** to leave programming mode.

To turn Call Forward on and off (once it has been programmed):

1. Press **SUPERKEY**.
2. Press **#** until "Call Forwarding?" appears.
3. Press ***** for Yes, and then **#** for external call forwarding.
4. To turn call forwarding on or off. press *****, and then press **#**.
5. Continue with other types of Call Forward or press **SUPERKEY** to leave programming mode.

Call Forward - I'm Here

To forward calls from a remote station to your current location:

1. Press **SUPERKEY**.
2. Press **#** until "Call Forwarding?" appears.
3. Press ***** for Yes, and then choose internal call forwarding or external call forwarding.
4. Press **#** until "I'm Here?" appears.
5. Press ***** for Yes.
6. Dial the remote extension number.
7. Press **⏺** to save.
8. Press **SUPERKEY** to exit.

To cancel Call Forward - I'm Here from the station that set the remote forwarding:

1. Lift the handset.
2. Dial ***07**.
3. Dial the extension of the remote station.
4. Hang up.

To cancel Call Forward - I'm Here from the station that was forwarded:

1. Press **SUPERKEY**.
2. Press **#** until "Call Forwarding?" appears.
3. Press ***** for Yes.
4. If "External Calls?* appears, do the following:
 - a. Press ***** twice.
 - b. Press **#** to cancel Call Forward - I'm Here.
 - c. Press **#** until "Internal Calls?* appears.
 - d. Press ***** twice.
 - e. Press **#** to cancel Call Forward - I'm Here.
5. If "External Calls?* does NOT appear, do the following:
 - a. Press ***** twice.
 - b. Press **#** to cancel Call Forward - I'm Here.

Call Forward - Forced

To force an incoming call to be forwarded:

- Press the **Forward Call** feature key.

To immediately transfer to another extension's No Answer forwarding destination when making a call:

- Press the **Forward Call** feature key when it lights.
Note: For information on programming a feature key, see "Feature Keys" elsewhere in this guide.

Call Forward - Toggle

This feature is useful if you want call forwarding in effect for Busy and No Answer conditions most of the time, but need to override it with Call Forward Always occasionally—for example, when you're using a second phone. Instead of changing the call forward programming on your main phone to turn Call Forward Always on and off, you can program a key to do it.

You can also program keys to turn Call Forward Busy, No Answer or Busy/No Answer on and off.

To toggle call forward:

- Press the programmed feature key: **Forward Always**, **Forward Busy**, **Forward No Ans**, or **Forward Busy/NA**.
Note: For information on programming a feature key, see "Feature Keys" elsewhere in this guide.

Note: You may also program a **Forward All** feature key to enable and disable all call forward types that have a destination programmed.

Messaging - Advisory

To turn Messaging - Advisory on:

1. Press **SUPERKEY**.
2. Press * to select ADVISORY MSGS.
3. Press # until the desired message appears.
4. Press * to turn on Advisory Messages.
5. Press **SUPERKEY** to exit.

To turn Messaging - Advisory off:

1. Press **SUPERKEY**.
2. Press * to select ADVISORY MSGS.
3. Press * to turn off Advisory Messages.
4. Press **SUPERKEY** to exit.

Messaging - Callback

To leave a Callback Message on a telephone when you hear busy or ringback tone:

- Press **MESSAGE**.

To respond to a Message Waiting condition on your telephone:

1. Lift the handset.
2. Press **MESSAGE**.
3. Dial **3**.

A call is placed to the message sender (voice mail system or extension user) that left the oldest message.

To view information about the messages before responding:

1. Press **MESSAGE**.
2. Do one of the following.
 - To call the message sender, press #.
 - To erase the message, press *.
 - To view the next message, press **MESSAGE**.

USING ADVANCED FEATURES

Account Codes

To enter an Account Code at the start of a call:

1. Press the **Account Code** feature key.
2. Enter the account code.
3. Dial the telephone number.

Note: For information on programming a feature key, see "Feature Keys" elsewhere in this guide.

Callback

To request a Callback when you reach a busy or unanswered telephone:

- Press the **Callback** feature key.

Note: For information on programming a feature key, see "Feature Keys" elsewhere in this guide.

To answer a Callback:

- Lift the handset.

Call Park

To park a call that is on your prime line (Line 1 key):

- Press the **Call Park** feature key.
-OR-
Press **TRANS/CONF** and then dial ***33**.

The call is parked and you receive dial tone on your prime line.

To retrieve a parked call from your phone while your phone is idle, or while you are off-hook and hearing dial tone:

- Press the **Call Park** feature key.
-OR-
Dial ***22**.

To retrieve a parked call while you are on a call on your prime line:

- Press the **Call Park** feature key.
-OR-
Press **TRANS/CONF** and then dial ***22**.

You are connected to the parked call and the caller that was on your prime line is parked.

To retrieve a parked call from another phone:

1. Lift the handset.
2. Dial ***23**.
3. Dial the prime line number (extension number) of the phone that parked the call.

Note: If the phone has both a parked call and a call on hold, dialing the Remote Hold Retrieve access code will retrieve the parked call.

Call Park - System

This feature allows you to park a call from any line on your telephone not just the prime line. The number of calls you can park is limited only by the number available system park "orbits."

To park a call in system orbit:

1. Press the lit **System Park** feature key.
2. Do either of the following:
 - Hang up
 - Press a line key to answer a call, retrieve a call or hold, or get dial tone.

To return to the caller if all the system orbits are busy:

- Press **CANCEL** to return to the caller.

To retrieve a call parked on a system orbit from any extension:

- While listening to dial tone, dial ***57** followed by the park orbit number.

Call Park - Specific Orbit

This feature allows you to park a call in a specific orbit by entering a two-digit orbit number or by pressing a feature key assigned to a specific orbit number.

To park a call in a specific orbit:

1. Press the **System Park** feature key.
2. Enter a two-digit Orbit Number (01-25).
If the selected orbit already has a parked call, press CANCEL to return to the caller, and then repeat steps 1 and 2 above.

To retrieve a call parked in a specific orbit:

- While listening to dial tone, dial ***/57** followed by the park orbit number.

To park a call in a specific orbit using an Orbit # feature key:

- Press a free (unlit) **Orbit #** feature key. (See "Feature Key" for instructions on programming a feature key.)

Once a call is parked, you can press the same **Orbit #** to initiate a page.

To retrieve a call parked using an Orbit # feature key:

- Press the flashing **Orbit #** feature key.

Call Pickup

To answer a call that is ringing at another station in your Pickup Group:

1. Lift the handset.
2. Press the **Pickup** feature key.
Note: For information on programming a feature key, see "Feature Keys" elsewhere in this guide.

To answer a call that is ringing at a station not in your Pickup Group:

1. Lift the handset.
2. Dial ***09**.
3. Dial the number of the ringing station.

Call Park - Destination Phone

Call Park - Destination Phone allows you to park an answered call on another phone. If a parked call is not retrieved after a specified length of time, a reminder occurs.

To park an active call on another phone:

1. Press **TRANS/CONF** to get dial tone.
2. Dial ***62**, and then dial the extension of the destination phone.
If the call is parked successfully, dial tone, busy tone or a page occurs. If the call is not parked, reorder tone occurs.

To retrieve a call parked on another phone:

- Do one of the following:
 - Press the flashing **Call Park** feature key.
 - Dial ***22**.
- Note:** For information on programming a feature key, see "Feature Keys" elsewhere in this guide.

Campon

To campon to a busy station:

- Press the **Campon** feature key.
Note: For information on programming a feature key, see "Feature Keys" elsewhere in this guide.

To retrieve a call when you hear Campon tone:

- Press the **Swap/Trade** feature key.

Do Not Disturb

To activate and deactivate Do Not Disturb:

- Press the **Do Not Disturb** feature key. The key flashes to indicate that Do Not Disturb is active.
Note: For information on programming a feature key, see "Feature Keys" elsewhere in this guide.

Override (Intrude)

To use Override when you encounter busy or DND tone:

- Press the **Intrude** feature key.

Note: For information on programming a feature key, see "Feature Keys" elsewhere in this guide.

Paging - PA

To use Paging:

1. Lift the handset.
2. Do one of the following:
 - To page the default zone, press the **PA Page** feature key.
 - To page a specific zone, dial ***13** followed by the zone number (0-9).
3. Make the announcement.

Note: For information on programming a feature key, see "Feature Keys" elsewhere in this guide.

Paging - Direct

To page an extension that has Whisper Announce or Off-Hook Voice Announce enabled:

1. Lift the handset.
2. Press the **Direct Page** feature key.
3. Dial the extension number.
4. Page the called party.

Note: For information on programming a feature key, see "Feature Keys" elsewhere in this guide.

To answer a page (indicated by a single burst of tone) when your phone is idle:

- Lift the handset.

Note: You can answer and respond handsfree to a Direct Page by using the Auto-Latch Microphone feature described elsewhere in this guide .

To answer a page while on a call:

1. Press the **RESPOND** feature key and hold it down as you speak. Your other call is placed on hold.
2. Release the **RESPOND** key to disconnect the paging caller and return to your held call.

Paging - All Set

To page all telephones simultaneously through their speakers:

1. Lift the handset.
2. Press the **Direct Page** feature key.
3. Press *.
4. Page the called party.

Note: For information on programming a feature key, see "Feature Keys" elsewhere in this guide.

To answer an All Set Page:

1. Lift the handset.
2. Dial ***49**.

Paging - Group

To page all telephones in a paging group simultaneously through their speakers:

1. Lift the handset.
2. Press the **Direct Page** feature key.
3. Press **#**.
4. Page the called parties.

Note: For information on programming a feature key, see "Feature Keys" elsewhere in this guide.

To respond to a Group Page:

1. Lift the handset.
2. Dial ***49**.

Handset Mute

To mute your handset's microphone during a call:

- Press the **Handset Mute** feature key.

Note: For information on programming a feature key, see "Feature Keys" elsewhere in this guide.

To restore handset microphone operation:

- Press the **Handset Mute** feature key again.

Direct Station Select/Busy Lamp Field (DSS/BLF)

Your phone may have keys programmed to place calls to other extensions and to show the status (idle, busy or DND) of those extensions.

To call the DSS/BLF extension:

- Press the **DSS/BLF** key.

To transfer a call to DSS/BLF extension (without Secretarial option):

1. Press the **TRANS/CONF** key.
2. Press the **DSS/BLF** key.

To transfer a call to a station (with Secretarial option):

- Press the **DSS/BLF** key.

DSS/BLF/Call Pickup

Your phone may have keys programmed to show the status (idle, busy, ringing, call on hold) of another destination and to retrieve calls ringing or on hold at the destination.

To retrieve a call ringing at the DSS/BLF destination:

- Press the slowly flashing **DSS/BLF** key.

To retrieve a call on hold at the DSS/BLF destination:

- Press the rapidly flashing **DSS/BLF** key.

Direct Page/BLF

Your phone may have keys programmed to show the busy/idle status of another extension and to page the extension.

To page a DP/BLF extension:

- Press the **DP/BLF** key.

You can page when the DP/BLF extension is idle (key dark) or busy (key steadily lit).

DSS/BLF/Direct Page/Call Pickup

Your phone may have keys that show the status (idle, busy, ringing, or call on hold) of another extension. Depending on the programming of the key, pressing it will either call the extension if it is idle, or retrieve a call ringing or on hold at the extension, or page the extension.

To pick up a call ringing at the DSS/BLF extension:

- Press the slowly flashing **DSS/BLF** key.

To retrieve a call on hold at the DSS/BLF extension:

- Press the rapidly flashing **DSS/BLF** key.

To page a DSS/BLF extension:

- Press the dark or steadily lit **DSS/BLF** key.

Park and Page

With Park and Page, you can park a call and initiate a page all in one step. Park and Page options include

- Park and Page Set: After a call is parked, the system performs an all-set page.
- Park and Page Group: After a call is parked, the system pages your Paging Group.
- Park and Page: After a call is parked, you must enter the extension or Page Group number.
- Park and PA Page: After a call is parked, the you must enter a Paging Zone number (0-9).

Note: For information on programming a feature key, see "Feature Keys" elsewhere in this guide.

To park a call and page a call:

1. Answer or make a call.
2. Perform one of the following:
 - To page all phones and the PA, press the **Park & Page Sets** feature key.
OR
Press **TRANS/CONF**, dial ***63** and dial *****.
 - To page all phones in a group and the PA, press the **Park & Page Grp** feature key.
OR
Press **TRANS/CONF**, dial ***63** and press **#**.
 - To page an extension number, press the **Park & Page** feature key and dial the extension.
OR
Press **TRANS/CONF**, dial ***63** and dial the extension.
 - To page all phones in a specified group and the PA, press the **Park & Page** feature key and dial the two-digit Page Group Number.
OR
Press **TRANS/CONF**, dial ***63** and dial the two-digit Page Group Number, then **#**.
 - To park a call in orbit and perform a PA Page to any or all nine Paging Zones, press the **Park & PA Page** feature key and dial the Paging Zone number (0 for all zones, 1-9 for a specific zone).
OR
Press **TRANS/CONF**, dial ***64** and dial the Paging Zone number (0 for all zones, 1-9 for a specific zone)

Note: To Park and Page call using speed call keys, press **TRANS/CONF** to get dial tone before pressing a speed call key programmed with the Park and Page access codes plus the digits for the required paging option (for example, an extension number to page a single phone or ***** to page all phones plus PA paging).

Record a Call

This feature uses your voice mail system to record your telephone conversations.

Note: You may be required by law to inform the other party that you are recording the conversation. For specific instructions, consult your system administrator.

To start recording while on a 2-party call:

- Press the **Record Call** feature key. (See Feature Keys elsewhere in this guide for instructions on programming a **Record Call** key to your phone.)

Note: Your system may be programmed to automatically begin recording external calls when you or the other answers.

To stop and save a recording:

- Press the **Record Call** feature key.

Putting the call on hold saves the recording; taking the call off hold starts a new recording. Depending on system programming, hanging up, or pressing **TRANS/CONF** or a **DSS** key, may also save the recording.

To stop and erase a recording:

- Press the **Cancel** softkey.

To listen to a recording:

1. Lift the handset.
2. Access your voice mailbox.
3. Follow the prompts to retrieve the recording.

Auto-Latch Microphone

To set the handsfree microphone to automatically turn on or off when receiving a page or Intercom call:

1. Press **SUPERKEY**.
2. Press **#** until ""Auto Latch Mic?"" appears.
3. Press ***** to turn on or turn off auto-latch microphone.
The **MICROPHONE** key flashes to indicate that the Auto-Latch Microphone feature is in use.

Reminder

To set or modify a timed reminder:

1. Lift the handset.
2. Dial ***32**.
3. Set a time by entering the hour and minutes in 24-hour format. For example, entering 1415 sets a reminder for 2:15 PM.
You hear dial tone if the time is valid; reorder tone if it is invalid.

To cancel a timed reminder:

1. Lift the handset.
2. Dial ***32** followed by 9999.
3. Hang up.
The reminder is cancelled.

To acknowledge the reminder (indicated by five rings).

- Lift the handset.

Reminder - Multiple

To set multiple reminders (up to three):

1. Lift the handset.
2. Dial ***32**.
3. Dial # followed by the number of the timer (#1, #2, or #3). To repeat the timer daily, dial *.
4. Set a time by entering the hour and minutes in 24-hour format. For example, entering 1415 sets a reminder for 2:15 PM.
You hear dial tone if the time is valid; reorder tone if it is invalid.
5. Repeat for each additional timer.

To cancel the Timer 1 reminder:

1. Lift the handset.
2. Dial ***32** followed by 9999.
3. Replace the handset.

The reminder is cancelled.

To cancel multiple reminders:

1. Lift the handset.
2. Dial ***32** followed by **9999**.
3. Dial # followed by the timer number (#1, #2, or #3).
4. Dial **9999**.
5. Replace the handset.

To acknowledge the reminder (indicated by five rings).

- Lift the handset.

Music

To turn Music on and off when the phone is idle:

- Press the **Music** feature key.
Note: For information on programming a feature key, see "Feature Keys" elsewhere in this guide.

Phonebook

To access the Phonebook:

1. Dial ***65**.
2. Using the keypad, enter the name or extension of the person you wish to call.

Note: Only extensions that have a voice mailbox can be dialed using Phonebook.

Call Monitoring

This feature allows you to monitor another extension user's phone conversation, either with or without the user's knowledge.

If your system is programmed to notify users that they are being monitored, they hear a beep when monitoring begins. Users that have a display telephone also see your name and extension number in the display for the duration of the call.

When monitoring a call, you can listen to the conversation but you can't speak to either party, and they can't hear you. However, you can join the conversation by forming a three-party conference

A few conditions:

- The system may be programmed to disallow monitoring of any or all extensions.
- A user can only be monitored from one extension at a time. If you try to monitor someone who is already being monitored, you receive busy tone and BUSY appears in your display.
- If the user puts the caller on hold, transfers the call, or ends the call, you are disconnected and your monitoring session ends. Note that the system can be programmed to allow monitoring to continue while the call is on hold.
- While you are monitoring, you can't make or receive calls. Anyone who calls your telephone while you are monitoring receives busy tone. The caller can leave a callback, but is unable to camp on or override your monitoring session. If you want to place an outgoing call, you must first cancel your monitoring session.

To monitor a call:

1. Lift the handset.
2. Dial ***** followed by the number of the extension you wish to monitor.
If the user is on a call, INTRUDING followed by the user's extension number appears in your telephone display.
If the user is not on the phone, you hear busy tone and the user's extension number followed by the words IS IDLE are shown in your telephone display.
3. Press **Trans/Conf** to form a three-party conference with the user and the other party.
-OR-
Press **Exit** to end the monitoring session.

NOTE: If you wish to continue monitoring after exiting the conference, you must set up the monitor again.

Door Opener

Door Opener allows you to operate a third-party door opener. For example, when someone requires entry into a third-party building, a designated extension (or extensions) rings and on answering, the extension user can press a feature key or dial a feature access code to open the door.

To use Door Opener:

- Press the **Door Opener** feature key or press ***66**.
Note: For information on programming a feature key, see "Feature Keys" elsewhere in this guide.

Night/Day Service Switching

Office telephone systems are often placed into Night Service after regular hours. Calls then ring alternate answer points--either designated extensions or a night bell. Extension users can dial the Trunk Answer From Any Station (TAFAS) code to answer calls ringing the night bell.

If permitted by system programming, you can put the system into Day service or one of two night service modes, Night1 or Night2.

To switch between Night and Day Service:

- Press the **NIGHT/DAY** feature key. (See "Feature Key" for instructions on programming a feature key.)
In Night1 service, the light in the **NIGHT/DAY** feature key flashes slowly.
In Night2 service it flashes rapidly. In Day service, the light is off.

FEATURE ACCESS CODES

Tone Demonstration	27
Last Number Redial	*30
Call Hold Retrieve (Remote)	*23
Call Forwarding - Internal Only	*04
Call Forwarding - External Only	*05
Call Forwarding - All Calls	*03
Call Forwarding - I'm Here	*06
Call Forwarding - Cancel I'm Here	*07
Account Code Access	*01
Callback Busy <single digit only>	7
Callback - No Answer	*43
Call Park	*33
Dial Call Pickup	*08
Directed Call Pickup	*09
Call Park Remote	*62
Call Hold Retrieve (Local)	*22
Do Not Disturb	*10
Executive Busy Override <single digit only>	8
Paging Access To Default Zone(s)	*12
Paging Access To Specific Zones	*13
Direct Paging	*48
Automatic Wakeup/Reminder	*32
Retrieve Personal Speed Call	*52
Store Personal Speed Call	*51
Phonebook	*65
Silent Monitoring	*45
Open Door	*66



™, © Trademark of Mitel Networks Corporation.
© Copyright 2004, Mitel Networks Corporation.
All rights reserved.